

Preliminary Information

AMD-K6[®]

Processor

Data Sheet



Preliminary Information

© 1998 Advanced Micro Devices, Inc. All rights reserved.

Advanced Micro Devices, Inc. (“AMD”) reserves the right to make changes in its products without notice in order to improve design or performance characteristics.

The information in this publication is believed to be accurate at the time of publication, but AMD makes no representations or warranties with respect to the accuracy or completeness of the contents of this publication or the information contained herein, and reserves the right to make changes at any time, without notice. AMD disclaims responsibility for any consequences resulting from the use of the information included in this publication.

This publication neither states nor implies any representations or warranties of any kind, including but not limited to, any implied warranty of merchantability or fitness for a particular purpose. AMD products are not authorized for use as critical components in life support devices or systems without AMD’s written approval. AMD assumes no liability whatsoever for claims associated with the sale or use (including the use of engineering samples) of AMD products, except as provided in AMD’s Terms and Conditions of Sale for such products.

Trademarks

AMD, the AMD logo, and combinations thereof, K86, AMD-K5, and the AMD-K6 logo are trademarks, and RISC86 and AMD-K6 are registered trademarks of Advanced Micro Devices, Inc.

Microsoft and Windows are registered trademarks, and Windows NT is a trademark of Microsoft Corporation.

Netware is a registered trademark of Novell, Inc.

MMX is a trademark and Pentium is a registered trademark of Intel Corporation.

The TAP State Diagram is reprinted from IEEE Std 1149.1-1990 “IEEE Standard Test Access Port and Boundary-Scan Architecture,” Copyright © 1990 by the Institute of Electrical and Electronics Engineers, Inc. The IEEE disclaims any responsibility or liability resulting from the placement and use in the described manner. Information is reprinted with the permission of the IEEE.

Other product names used in this publication are for identification purposes only and may be trademarks of their respective companies.

Contents

Revision History	xvii
About This Data Sheet	1

Part One

AMD-K6[®] Processor Family	3
1 AMD-K6 [®] Processor	5
2 Internal Architecture	7
2.1 Introduction	7
2.2 AMD-K6 [®] Processor Microarchitecture Overview	7
Enhanced RISC86 [®] Microarchitecture	8
2.3 Cache, Instruction Prefetch, and Predecode Bits	11
Cache	11
Prefetching	12
Predecode Bits	12
2.4 Instruction Fetch and Decode	13
Instruction Fetch	13
Instruction Decode	14
2.5 Centralized Scheduler	16
2.6 Execution Units	17
2.7 Branch-Prediction Logic	19
Branch History Table	19
Branch Target Cache	19
Return Address Stack	20
Branch Execution Unit	20
3 Software Environment	21
3.1 Registers	21
General-Purpose Registers	21
Integer Data Types	23
Segment Registers	24
Segment Usage	24
Instruction Pointer	25
Floating-Point Registers	25
Floating-Point Register Data Types	28
MMX [™] Registers	29
EFLAGS Register	31
Control Registers	32
Debug Registers	34
Model-Specific Registers (MSR)	37

	Memory Management Registers	39
	Task State Segment	41
	Paging	42
	Descriptors and Gates	45
	Exceptions and Interrupts	48
3.2	Instructions Supported by the AMD-K6 Processor	49
4	Logic Symbol Diagram	77
5	Signal Descriptions	79
5.1	A20M# (Address Bit 20 Mask)	79
5.2	A[31:3] (Address Bus)	80
5.3	ADS# (Address Strobe)	81
5.4	ADSC# (Address Strobe Copy)	81
5.5	AHOLD (Address Hold)	82
5.6	AP (Address Parity)	83
5.7	APCHK# (Address Parity Check)	84
5.8	BE[7:0]# (Byte Enables)	85
5.9	BF[2:0] (Bus Frequency)	86
5.10	BOFF# (Backoff)	87
5.11	BRDY# (Burst Ready)	88
5.12	BRDYC# (Burst Ready Copy)	89
5.13	BREQ (Bus Request)	90
5.14	CACHE# (Cacheable Access)	90
5.15	CLK (Clock)	91
5.16	D/C# (Data/Code)	91
5.17	D[63:0] (Data Bus)	92
5.18	DP[7:0] (Data Parity)	93
5.19	EADS# (External Address Strobe)	94
5.20	EWBE# (External Write Buffer Empty)	95
5.21	FERR# (Floating-Point Error)	96
5.22	FLUSH# (Cache Flush)	97
5.23	HIT# (Inquire Cycle Hit)	98
5.24	HITM# (Inquire Cycle Hit To Modified Line)	98
5.25	HLDA (Hold Acknowledge)	99
5.26	HOLD (Bus Hold Request)	99
5.27	IGNNE# (Ignore Numeric Exception)	100
5.28	INIT (Initialization)	101
5.29	INTR (Maskable Interrupt)	102
5.30	INV (Invalidation Request)	102
5.31	KEN# (Cache Enable)	103
5.32	LOCK# (Bus Lock)	104
5.33	M/IO# (Memory or I/O)	105
5.34	NA# (Next Address)	106
5.35	NMI (Non-Maskable Interrupt)	106
5.36	PCD (Page Cache Disable)	107
5.37	PCHK# (Parity Check)	108
5.38	PWT (Page Writethrough)	109

5.39	RESET (Reset)	110
5.40	RSVD (Reserved)	110
5.41	SCYC (Split Cycle)	111
5.42	SMI# (System Management Interrupt)	111
5.43	SMIACT# (System Management Interrupt Active)	112
5.44	STPCLK# (Stop Clock)	113
5.45	TCK (Test Clock)	113
5.46	TDI (Test Data Input)	114
5.47	TDO (Test Data Output)	114
5.48	TMS (Test Mode Select)	114
5.49	TRST# (Test Reset)	115
5.50	VCC2DET (V _{CC2} Detect)	115
5.51	W/R# (Write/Read)	115
5.52	WB/WT# (Writeback or Writethrough)	116
6	Bus Cycles	121
6.1	Timing Diagrams	121
6.2	Bus State Machine Diagram	123
	Idle	124
	Address	124
	Data	124
	Data-NA# Requested	124
	Pipeline Address	124
	Pipeline Data	125
	Transition	125
6.3	Memory Reads and Writes	126
	Single-Transfer Memory Read and Write	126
	Misaligned Single-Transfer Memory Read and Write	128
	Burst Reads and Pipelined Burst Reads	130
	Burst Writeback	132
6.4	I/O Read and Write	134
	Basic I/O Read and Write	134
	Misaligned I/O Read and Write	135
6.5	Inquire and Bus Arbitration Cycles	136
	Hold and Hold Acknowledge Cycle	136
	HOLD-Initiated Inquire Hit to Shared or Exclusive Line	138
	HOLD-Initiated Inquire Hit to Modified Line	140
	AHOLD-Initiated Inquire Miss	142
	AHOLD-Initiated Inquire Hit to Shared or Exclusive Line	144
	AHOLD-Initiated Inquire Hit to Modified Line	146
	AHOLD Restriction	148
	Bus Backoff (BOFF#)	150
	Locked Cycles	152
	Basic Locked Operation	152
	Locked Operation with BOFF# Intervention	154
	Interrupt Acknowledge	156

6.6	Special Bus Cycles	158
	Basic Special Bus Cycle	158
	Shutdown Cycle	160
	Stop Grant and Stop Clock States	161
	INIT-Initiated Transition from Protected Mode to Real Mode	164
7	Power-on Configuration and Initialization	167
7.1	Signals Sampled During the Falling Transition of RESET	167
	FLUSH#	167
	BF[2:0]	167
	BRDYC#	167
7.2	RESET Requirements	168
7.3	State of Processor After RESET	168
	Output Signals	168
	Registers	168
7.4	State of Processor After INIT	170
8	Cache Organization	171
8.1	MESI States in the Data Cache	172
8.2	Predecode Bits	172
8.3	Cache Operation	173
	Cache-Related Signals	175
8.4	Cache Disabling	175
8.5	Cache-Line Fills	176
8.6	Cache-Line Replacements	177
8.7	Write Allocate	177
	Write to a Cacheable Page	178
	Write to a Sector	178
	Write Allocate Limit	178
	Descriptions of the Logic Mechanisms and Conditions	180
8.8	Prefetching	181
8.9	Cache States	182
8.10	Cache Coherency	183
	Inquire Cycles	183
	Internal Snooping	183
	FLUSH#	184
	WBINVD and INVD	184
	Cache-Line Replacement	184
	Cache Snooping	186
8.11	Writethrough vs. Writeback Coherency States	187
8.12	A20M# Masking of Cache Accesses	187
9	Floating-Point and Multimedia Execution Units	189
9.1	Floating-Point Execution Unit	189
	Handling Floating-Point Exceptions	189
	External Logic Support of Floating-Point Exceptions	189

9.2	Multimedia Execution Unit	191
9.3	Floating-Point and MMX Instruction Compatibility	191
	Registers	191
	Exceptions	191
	FERR# and IGNNE#	191
10	System Management Mode (SMM)	193
10.1	Overview	193
10.2	SMM Operating Mode and Default Register Values	193
10.3	SMM State-Save Area	196
10.4	SMM Revision Identifier	198
10.5	SMM Base Address	199
10.6	Halt Restart Slot	199
10.7	I/O Trap Dword	200
10.8	I/O Trap Restart Slot	201
10.9	Exceptions, Interrupts, and Debug in SMM	202
11	Test and Debug	203
11.1	Built-In Self-Test (BIST)	203
11.2	Tri-State Test Mode	204
11.3	Boundary-Scan Test Access Port (TAP)	205
	Test Access Port	205
	TAP Signals	205
	TAP Registers	206
	TAP Instructions	211
	TAP Controller State Machine	212
11.4	L1 Cache Inhibit	215
	Purpose	215
11.5	Debug	216
	Debug Registers	216
	Debug Exceptions	221
12	Clock Control	223
12.1	Halt State	224
	Enter Halt State	224
	Exit Halt State	224
12.2	Stop Grant State	225
	Enter Stop Grant State	225
	Exit Stop Grant State	225
12.3	Stop Grant Inquire State	226
	Enter Stop Grant Inquire State	226
	Exit Stop Grant Inquire State	226
12.4	Stop Clock State	226
	Enter Stop Clock State	226
	Exit Stop Clock State	227

13	Power and Grounding	229
	13.1 Power Connections	229
	13.2 Decoupling Recommendations	230
	13.3 Pin Connection Requirements	231
14	Electrical Data	233
	14.1 Operating Ranges	233
	14.2 Absolute Ratings	233
	14.3 DC Characteristics	234
	14.4 Power Dissipation	235
15	I/O Buffer Characteristics	237
	15.1 Selectable Drive Strength	237
	15.2 I/O Buffer Model	238
	15.3 I/O Model Application Note	239
	15.4 I/O Buffer AC and DC Characteristics	239
16	Signal Switching Characteristics	241
	16.1 CLK Switching Characteristics	241
	16.2 Clock Switching Characteristics for 66-MHz Bus Operation	242
	16.3 Clock Switching Characteristics for 60-MHz Bus Operation	242
	16.4 Valid Delay, Float, Setup, and Hold Timings	243
	16.5 Output Delay Timings for 66-MHz Bus Operation	244
	16.6 Input Setup and Hold Timings for 66-MHz Bus Operation	246
	16.7 Output Delay Timings for 60-MHz Bus Operation	248
	16.8 Input Setup and Hold Timings for 60-MHz Bus Operation	250
	16.9 RESET and Test Signal Timing	252
17	Thermal Design	259
	17.1 Package Thermal Specifications	259
	Heat Dissipation Path	261
	Measuring Case Temperature	262
	17.2 Layout and Airflow Considerations	262
	Voltage Regulator	262
	Airflow Management in a System Design	264
18	Pin Description Diagram	267
19	Pin Designations	269
20	Package Specifications	271
	20.1 321-Pin Staggered CPGA Package Specification	271
21	Ordering Information	273

Part Two

AMD-K6 Processor Model 7	275
22	AMD-K6 Processor 277
23	Internal Architecture 279
24	Software Environment 281
24.1	Registers 281
	Model-Specific Registers (MSR) 281
24.2	Instructions Supported by the AMD-K6 Processor 283
25	Logic Symbol Diagram 285
26	Signal Descriptions 287
26.1	VCC2DET (V _{CC2} Detect) 287
26.2	VCC2H/L# (V _{CC2} High/Low) 287
27	Bus Cycles 289
28	Power-on Configuration and Initialization 291
28.1	State of Processor After RESET 291
	Output Signals 291
29	Cache Organization 293
30	Floating-Point and Multimedia Execution Units 295
31	System Management Mode (SMM) 297
32	Test and Debug 299
32.1	Tri-State Test Mode 299
32.2	Boundary-Scan Test Access Port (TAP) 299
	TAP Registers 300
33	Clock Control 301
34	Power and Grounding 303
34.1	Power Connections 303
35	Electrical Data 305
35.1	Operating Ranges 305
35.2	Absolute Ratings 305
35.3	DC Characteristics 306
35.4	Power Dissipation 307
36	I/O Buffer Characteristics 309

37	Signal Switching Characteristics	311
38	Thermal Design	313
	38.1 Package Thermal Specifications	313
39	Pin Description Diagram	315
40	Pin Designations	317
41	Package Specifications	319
42	Ordering Information	321
	Index	323

List of Figures

Part One

AMD-K6 Processor Family

3

Figure 1.	AMD-K6 Processor Block Diagram	11
Figure 2.	Cache Sector Organization	12
Figure 3.	The Instruction Buffer	13
Figure 4.	AMD-K6 Processor Decode Logic	14
Figure 5.	AMD-K6 Processor Scheduler	17
Figure 6.	EAX Register with 16-Bit and 8-Bit Name Components.	22
Figure 7.	Integer Data Types.	23
Figure 8.	Segment Register	24
Figure 9.	Segment Usage	25
Figure 10.	Floating-Point Register	26
Figure 11.	FPU Status Word Register	26
Figure 12.	FPU Control Word Register	27
Figure 13.	FPU Tag Word Register.	27
Figure 14.	Packed Decimal Data Type	28
Figure 15.	Precision Real Data Types	28
Figure 16.	MMX Registers	29
Figure 17.	MMX Data Types	30
Figure 18.	EFLAGS Registers	31
Figure 19.	Control Register 4 (CR4).	32
Figure 20.	Control Register 3 (CR3).	32
Figure 21.	Control Register 2 (CR2).	32
Figure 22.	Control Register 1 (CR1).	33
Figure 23.	Control Register 0 (CR0).	33
Figure 24.	Debug Register DR7	34
Figure 25.	Debug Register DR6	35
Figure 26.	Debug Registers DR5 and DR4.	35
Figure 27.	Debug Registers DR3, DR2, DR1, and DR0.	36
Figure 28.	Machine-Check Address Register (MCAR).	37
Figure 29.	Machine-Check Type Register (MCTR).	38
Figure 30.	Test Register 12 (TR12).	38
Figure 31.	Time Stamp Counter (TSC).	38
Figure 32.	Write Handling Control Register (WHCR)	39
Figure 33.	Memory Management Registers.	40
Figure 34.	Task State Segment (TSS).	41

Figure 35.	4-Kbyte Paging Mechanism	42
Figure 36.	4-Mbyte Paging Mechanism	43
Figure 37.	Page Directory Entry 4-Kbyte Page Table (PDE)	44
Figure 38.	Page Directory Entry 4-Mbyte Page Table (PDE)	44
Figure 39.	Page Table Entry (PTE)	45
Figure 40.	Application Segment Descriptor	46
Figure 41.	System Segment Descriptor	47
Figure 42.	Gate Descriptor	48
Figure 43.	Waveform Definitions	122
Figure 44.	Bus State Machine Diagram	123
Figure 45.	Non-Pipelined Single-Transfer Memory Read/Write and Write Delayed by EWBE#	127
Figure 46.	Misaligned Single-Transfer Memory Read and Write	129
Figure 47.	Burst Reads and Pipelined Burst Reads	131
Figure 48.	Burst Writeback due to Cache-Line Replacement	133
Figure 49.	Basic I/O Read and Write	134
Figure 50.	Misaligned I/O Transfer	135
Figure 51.	Basic HOLD/HLDA Operation	137
Figure 52.	HOLD-Initiated Inquire Hit to Shared or Exclusive Line	139
Figure 53.	HOLD-Initiated Inquire Hit to Modified Line	141
Figure 54.	AHOLD-Initiated Inquire Miss	143
Figure 55.	AHOLD-Initiated Inquire Hit to Shared or Exclusive Line	145
Figure 56.	AHOLD-Initiated Inquire Hit to Modified Line	147
Figure 57.	AHOLD Restriction	149
Figure 58.	BOFF# Timing	151
Figure 59.	Basic Locked Operation	153
Figure 60.	Locked Operation with BOFF# Intervention	155
Figure 61.	Interrupt Acknowledge Operation	157
Figure 62.	Basic Special Bus Cycle (Halt Cycle)	159
Figure 63.	Shutdown Cycle	160
Figure 64.	Stop Grant and Stop Clock Modes, Part 1	162
Figure 65.	Stop Grant and Stop Clock Modes, Part 2	163
Figure 66.	INIT-Initiated Transition from Protected Mode to Real Mode	165
Figure 67.	Cache Organization	171
Figure 68.	Cache Sector Organization	172
Figure 69.	Write Handling Control Register (WHCR)	179
Figure 70.	Write Allocate Logic Mechanisms and Conditions	180
Figure 71.	External Logic for Supporting Floating-Point Exceptions	190

Figure 72.	SMM Memory	195
Figure 73.	TAP State Diagram	213
Figure 74.	Debug Register DR7	217
Figure 75.	Debug Register DR6	218
Figure 76.	Debug Registers DR5 and DR4.	218
Figure 77.	Debug Registers DR3, DR2, DR1, and DR0.	219
Figure 78.	Clock Control State Transitions	228
Figure 79.	Suggested Component Placement	230
Figure 80.	K6STD Pulldown V/I Curves	239
Figure 81.	K6STD Pullup V/I Curves	239
Figure 82.	CLK Waveform	243
Figure 83.	Diagrams Key	254
Figure 84.	Output Valid Delay Timing	254
Figure 85.	Maximum Float Delay Timing	255
Figure 86.	Input Setup and Hold Timing	255
Figure 87.	Reset and Configuration Timing	256
Figure 88.	TCK Waveform	257
Figure 89.	TRST# Timing.	257
Figure 90.	Test Signal Timing Diagram	257
Figure 91.	Thermal Model	260
Figure 92.	Power Consumption vs. Thermal Resistance	260
Figure 93.	Processor Heat Dissipation Path	261
Figure 94.	Measuring Case Temperature.	262
Figure 95.	Voltage Regulator Placement.	263
Figure 96.	Airflow for a Heatsink with Fan.	263
Figure 97.	Airflow Path in a Dual-fan System	264
Figure 98.	Airflow Path in an ATX Form-Factor System	265
Figure 99.	AMD-K6 Processor Top-Side View	267
Figure 100.	AMD-K6 Processor Pin-Side View	268
Figure 101.	321-Pin Staggered CPGA Package Specification	272

Part Two

AMD-K6 Processor Model 7

275

Figure 102.	Extended Feature Enable Register (EFER)	282
Figure 103.	SYSCALL/SYSRET Target Address Register (STAR)	283
Figure 104.	AMD-K6 Processor Model 7 Top-Side View.	315
Figure 105.	AMD-K6 Processor Model 7 Pin-Side View	316

List of Tables

Part One

AMD-K6 Processor Family

3

Table 1.	Execution Latency and Throughput of Execution Units	18
Table 2.	General-Purpose Registers	21
Table 3.	General-Purpose Register Dword, Word, and Byte Names	22
Table 4.	Segment Registers	24
Table 5.	Model-Specific Registers (MSRs)	37
Table 6.	Memory Management Registers	39
Table 7.	Application Segment Types	46
Table 8.	System Segment and Gate Types	47
Table 9.	Summary of Exceptions and Interrupts	48
Table 10.	Integer Instructions	50
Table 11.	Floating-Point Instructions	68
Table 12.	MMX Instructions	72
Table 13.	Processor-to-Bus Clock Ratios	86
Table 14.	Input Pin Types	117
Table 15.	Output Pin Float Conditions	118
Table 16.	Input/Output Pin Float Conditions	118
Table 17.	Test Pins	118
Table 18.	Bus Cycle Definition	119
Table 19.	Special Cycles	119
Table 20.	Bus-Cycle Order During Misaligned Transfers	128
Table 21.	A[4:3] Address-Generation Sequence During Bursts	130
Table 22.	Bus-Cycle Order During Misaligned I/O Transfers	135
Table 23.	Interrupt Acknowledge Operation Definition	156
Table 24.	Encodings For Special Bus Cycles	158
Table 25.	Output Signal State After RESET	168
Table 26.	Register State After RESET	169
Table 27.	PWT Signal Generation	174
Table 28.	PCD Signal Generation	174
Table 29.	CACHE# Signal Generation	175
Table 30.	Data Cache States for Read and Write Accesses	182
Table 31.	Cache States for Inquiries, Snoops, Invalidation, and Replacement	185
Table 32.	Snoop Action	186
Table 33.	Initial State of Registers in SMM	195
Table 34.	SMM State-Save Area Map	196
Table 35.	SMM Revision Identifier	199
Table 36.	I/O Trap Dword Configuration	200

Table 37.	I/O Trap Restart Slot	201
Table 38.	Boundary Scan Bit Definitions	209
Table 39.	Device Identification Register	210
Table 40.	Supported Tap Instructions	211
Table 41.	DR7 LEN and RW Definitions	221
Table 42.	Operating Ranges	233
Table 43.	Absolute Ratings	233
Table 44.	DC Characteristics	234
Table 45.	Typical and Maximum Power Dissipation	235
Table 46.	A[20:3], ADS#, HITM#, and W/R# Strength Selection	237
Table 47.	CLK Switching Characteristics for 66-MHz Bus Operation	242
Table 48.	CLK Switching Characteristics for 60-MHz Bus Operation	242
Table 49.	Output Delay Timings for 66-MHz Bus Operation	244
Table 50.	Input Setup and Hold Timings for 66-MHz Bus Operation	246
Table 51.	Output Delay Timings for 60-MHz Bus Operation	248
Table 52.	Input Setup and Hold Timings for 60-MHz Bus Operation	250
Table 53.	RESET and Configuration Signals (60-MHz and 66-MHz Operation)	252
Table 54.	TCK Waveform and TRST# Timing at 25 MHz	253
Table 55.	Test Signal Timing at 25 MHz	253
Table 56.	Package Thermal Specification	259
Table 57.	321-Pin Staggered CPGA Package Specification	271
Table 58.	Valid Ordering Part Number Combinations	273

Part Two

AMD-K6 Processor Model 7

275

Table 59.	Model-Specific Registers (MSRs)	282
Table 60.	Extended Feature Enable Register (EFER) Definition	282
Table 61.	SYSCALL/SYSRET Target Address Register (STAR) Definition	283
Table 62.	Integer Instructions	283
Table 63.	Output Pin Float Conditions	288
Table 64.	Output Signal State After RESET	291
Table 65.	Register State After RESET	292
Table 66.	Device Identification Register	300
Table 67.	Operating Ranges	305
Table 68.	Absolute Ratings	305
Table 69.	DC Characteristics	306
Table 70.	Typical and Maximum Power Dissipation	307
Table 71.	Package Thermal Specification	313
Table 72.	Valid Ordering Part Number Combinations	321

Revision History

Date	Rev	Description
June 1997	E	Replaced overbar with # to identify active-Low signals.
June 1997	E	Corrected description in "Write Allocate" on page 177.
June 1997	E	Revised latency and throughput information in Table 1, "Execution Latency and Throughput of Execution Units," on page 18.
June 1997	E	Updated Figure 79, "Suggested Component Placement," on page 230 of Chapter 13, "Power and Grounding".
Sept 1997	F	Unreleased version.
March 1998	G	Divided book into Part 1 and Part 2. Part 1 provides information about the AMD-K6 [®] processor family (Model 6 and Model 7) and Part 2 provides information specific to the AMD-K6 processor Model 7 (0.25-micron process technology).
March 1998	G	Added Figure 17, "MMX™ Data Types," on page 30 in Chapter 3, "Software Environment".
March 1998	G	Qualified conditions under which Write Allocate occurs in the memory area between 640 Kbytes and 1 Mbyte in "Write Allocate Limit" on page 178 of Chapter 8, "Cache Organization".
March 1998	G	Changed power dissipation specifications for Stop Grant State and Stop Clock State for 166MHz, 200MHz, and 233MHz components in Table 45, "Typical and Maximum Power Dissipation," on page 235, and Table 56, "Package Thermal Specification," on page 259.
March 1998	G	Removed all references to Write KEN# Control Register (WKCR) from Chapter 3, "Software Environment", Chapter 5, "Signal Descriptions", and Chapter 8, "Cache Organization".
March 1998	G	Added top-side view pin description diagram. See Figure 99, "AMD-K6 [®] Processor Top-Side View," on page 267.
March 1998	G	Added voltage detection pin to diagram in Chapter 4, "Logic Symbol Diagram".
March 1998	G	Modified flatness specification (symbol f) in Table 57, "321-Pin Staggered CPGA Package Specification," on page 271.
March 1998	G	Corrected Figure 44, "Bus State Machine Diagram," on page 123 in Chapter 6, "Bus Cycles" to accurately show the direct transition from the Pipeline Data state to the Data-NA# Requested state.
March 1998	G	Corrected list of internal resources tested during BIST in Chapter 11, "Test and Debug" on page 203.
March 1998	G	Revised Figure 92, "Power Consumption vs. Thermal Resistance," on page 260 in Chapter 17, "Thermal Design".
March 1998	H	Revised signal description of VCC2H/L# on page 287 in Chapter 26, "Signal Descriptions".

About This Data Sheet

The AMD-K6[®] Processor Data Sheet supports the Model 6 and Model 7 versions of the AMD-K6 processor family. Model 6 refers to the AMD-K6 manufactured in the 0.35-micron process technology and Model 7 refers to the AMD-K6 manufactured in the 0.25-micron process technology. The data sheet is divided into two parts. Part One (chapters 1–21) contains information that pertains to the entire AMD-K6 desktop family and information specific to the Model 6. Part Two (chapters 22–42) contains information regarding new specifications and differences that pertain only to Model 7 as compared to Model 6.

Part One

AMD-K6[®] Processor Family

The AMD-K6[®] Processor Data Sheet supports the Model 6 and Model 7 versions of the AMD-K6 processor family. Model 6 refers to the AMD-K6 manufactured with 0.35-micron process technology and Model 7 refers to the AMD-K6 manufactured with 0.25-micron process technology. Part One (chapters 1–21) contains information that pertains to the entire AMD-K6 desktop family and information specific to Model 6.

1 AMD-K6[®] Processor

- Advanced 6-Issue RISC86[®] Superscalar Microarchitecture
 - ◆ Seven parallel specialized execution units
 - ◆ Multiple sophisticated x86-to-RISC86 instruction decoders
 - ◆ Advanced two-level branch prediction
 - ◆ Speculative execution
 - ◆ Out-of-order execution
 - ◆ Register renaming and data forwarding
 - ◆ Issues up to six RISC86 instructions per clock
- Large On-Chip Split 64-Kbyte Level-One (L1) Cache
 - ◆ 32-Kbyte instruction cache with additional predecode cache
 - ◆ 32-Kbyte writeback dual-ported data cache
 - ◆ MESI protocol support
- High-Performance IEEE 754-Compatible and 854-Compatible Floating-Point Unit
- High-Performance Industry-Standard MMX[™] Instructions
- 321-Pin Ceramic Pin Grid Array (CPGA) Package (Socket 7 Compatible)
- Industry-Standard System Management Mode (SMM)
- IEEE 1149.1 Boundary Scan
- Full x86 Binary Software Compatibility

As the next generation in the AMD K86[™] family of x86 processors, the innovative AMD-K6 processor brings industry-leading performance to PC systems running the extensive installed base of x86 software. In addition, its socket 7 compatible, 321-pin Ceramic Pin Grid Array (CPGA) package enables the AMD-K6 to reduce time-to-market by leveraging today's cost-effective infrastructure to deliver a superior price/performance PC solution.

To provide state-of-the-art performance, the AMD-K6 processor incorporates the innovative and efficient RISC86 microarchitecture, a large 64-Kbyte level-one cache (32-Kbyte dual-ported data cache, 32-Kbyte instruction cache with predecode data), a powerful IEEE 754-compatible and 854-compatible floating-point execution unit, and a high-performance multimedia execution unit for executing industry-standard MMX instructions. These features have been combined to deliver industry leadership in 16-bit and 32-bit performance, providing exceptional performance for both Windows[®] 95 and Windows NT[™] software bases.

The AMD-K6 processor's RISC86 microarchitecture is a decoupled decode/execution superscalar design that implements state-of-the-art design techniques to achieve leading-edge performance. Advanced design techniques implemented in the AMD-K6 include multiple x86 instruction decode, single-clock internal RISC operations, seven execution units that support superscalar operation, out-of-order execution, data forwarding, speculative execution, and register renaming. In addition, the processor supports the industry's most advanced branch prediction logic by implementing an 8192-entry branch history table, the industry's only branch target cache, and a return address stack, which combine to deliver better than a 95% prediction rate. These design techniques enable the AMD-K6 processor to issue, execute, and retire multiple x86 instructions per clock, resulting in excellent scaleable performance.

The AMD-K6 processor is fully x86 binary code compatible. AMD's extensive experience through four generations of x86 processors has been carefully integrated into the AMD-K6 to provide complete compatibility with Windows 95, Windows 3.x, Windows NT, DOS, OS/2, Unix, Solaris, NetWare[®], Vines, and other leading x86 operating systems and applications. The AMD-K6 processor is Socket 7 compatible, allowing the processor to be quickly and easily integrated into a mature and cost-effective industry-standard infrastructure of motherboards, chipsets, power supplies, and thermal designs.

AMD has designed, manufactured, and delivered over 50 million Microsoft[®] Windows-compatible processors in the last five years alone. The AMD-K6 processor is the next generation in this long line of processors. With its combination of state-of-the-art features, industry-leading performance, high-performance multimedia engine, full x86 compatibility, and low-cost infrastructure, the AMD-K6 is the superior choice for mainstream personal computers.

2 Internal Architecture

2.1 Introduction

The AMD-K6 processor implements advanced design techniques known as the RISC86 microarchitecture. The RISC86 microarchitecture is a decoupled decode/execution design approach that yields superior sixth-generation performance for x86-based software. This chapter describes the techniques used and the functional elements of the RISC86 microarchitecture.

2.2 AMD-K6[®] Processor Microarchitecture Overview

When discussing processor design, it is important to understand the terms *architecture*, *microarchitecture*, and *design implementation*. The term *architecture* refers to the instruction set and features of a processor that are visible to software programs running on the processor. The architecture determines what software the processor can run. The architecture of the AMD-K6 processor is the industry-standard x86 instruction set.

The term *microarchitecture* refers to the design techniques used in the processor to reach the target cost, performance, and functionality goals. The AMD-K6 is based on a sophisticated RISC core known as the Enhanced RISC86 microarchitecture. The Enhanced RISC86 microarchitecture is an advanced, second-order decoupled decode/execution design approach that enables industry-leading performance for x86-based software.

The term *design implementation* refers to the actual logic and circuit designs from which the processor is created according to the microarchitecture specifications.

**Enhanced RISC86[®]
Microarchitecture**

The Enhanced RISC86 microarchitecture defines the characteristics of the AMD-K6. The innovative RISC86 microarchitecture approach implements the x86 instruction set by internally translating x86 instructions into RISC86 operations. These RISC86 operations were specially designed to include direct support for the x86 instruction set while observing the RISC performance principles of fixed length encoding, regularized instruction fields, and a large register set. The Enhanced RISC86 microarchitecture used in the AMD-K6 enables higher processor core performance and promotes straightforward extensibility in future designs. Instead of directly executing complex x86 instructions, which have lengths of 1 to 15 bytes, the AMD-K6 processor executes the simpler and easier fixed-length RISC86 opcodes, while maintaining the instruction coding efficiencies found in x86 programs.

The AMD-K6 processor contains parallel decoders, a centralized RISC86 operation scheduler, and seven execution units that support superscalar operation—multiple decode, execution, and retirement—of x86 instructions. These elements are packed into an aggressive and highly efficient six-stage pipeline.

Decoders. Decoding of the x86 instructions begins when the on-chip instruction cache is filled. Predecode logic determines the length of an x86 instruction on a byte-by-byte basis. This predecode information is stored, along with the x86 instructions, in the instruction cache, to be used later by the decoders. The decoders translate on-the-fly, with no additional latency, up to two x86 instructions per clock into RISC86 operations.

Note: In this chapter, “clock” refers to a processor clock.

The AMD-K6 processor categorizes x86 instructions into three types of decodes—short, long and vector. The decoders process either two short, one long, or one vector decode at a time. The three types of decodes have the following characteristics:

- Short decodes—x86 instructions less than or equal to seven bytes in length
- Long decodes—x86 instructions less than or equal to 11 bytes in length
- Vector decodes—complex x86 instructions

Short and long decodes are processed completely within the decoders. Vector decodes are started by the decoders and then completed by fetched sequences from an on-chip ROM. After decoding, the RISC86 operations are delivered to the scheduler for dispatching to the executions units.

Scheduler/Instruction Control Unit. The centralized scheduler or buffer is managed by the Instruction Control Unit (ICU). The ICU buffers and manages up to 24 RISC86 operations at a time. This equals from 6 to 12 x86 instructions. This buffer size (24) is perfectly matched to the processor's six-stage RISC86 pipeline and seven parallel execution units. The scheduler accepts as many as four RISC86 operations at a time from the decoders. The ICU is capable of simultaneously issuing up to six RISC86 operations at a time to the execution units. This consists of the following types of operations:

- Memory load operation
- Memory store operation
- Complex integer or MMX register operation
- Simple integer register operation
- Floating-point register operation
- Branch condition evaluation

Registers. The scheduler uses 48 physical registers that are contained within the RISC86 microarchitecture when managing the 24 RISC86 operations. The 48 physical registers are located in a general register file and are grouped as 24 general registers, plus 24 renaming registers. The 24 general registers consist of 16 scratch registers and eight registers that correspond to the x86 general purpose registers—EAX, EBX, ECX, EDX, EBP, ESP, ESI and EDI.

Branch Logic. The AMD-K6 processor is designed with highly sophisticated dynamic branch logic consisting of the following:

- Branch history/Prediction table
- Branch target cache
- Return address stack

The AMD-K6 implements a two-level branch prediction scheme based on an 8192-entry branch history table. The branch history table stores prediction information that is used for predicting conditional branches. Because the branch history table does not

store predicted target addresses, special address ALUs calculate target addresses on-the-fly during instruction decode. The branch target cache augments predicted branch performance by avoiding a one clock cache-fetch penalty. This specialized target cache does this by supplying the first 16 bytes of target instructions to the decoders when branches are predicted. The return address stack is a unique device specifically designed for optimizing CALL and RETURN pairs. In summary, the AMD-K6 uses dynamic branch logic to minimize delays due to the branch instructions that are common in x86 software.

AMD-K6[®] Processor Block Diagram. As shown in Figure 1 on page 11, the high-performance, out-of-order execution engine of the AMD-K6 processor is mated to a split level-one 64-Kbyte writeback cache with 32 Kbytes of instruction cache and 32 Kbytes of data cache. The instruction cache feeds the decoders and, in turn, the decoders feed the scheduler. The ICU issues and retires RISC86 operations contained in the scheduler. The system bus interface is an industry-standard 64-bit Pentium[®] processor demultiplexed bus.

The AMD-K6 processor combines the latest in processor microarchitecture to provide the highest x86 performance for today's personal computers. The AMD-K6 offers true sixth-generation performance and full x86 binary software compatibility.

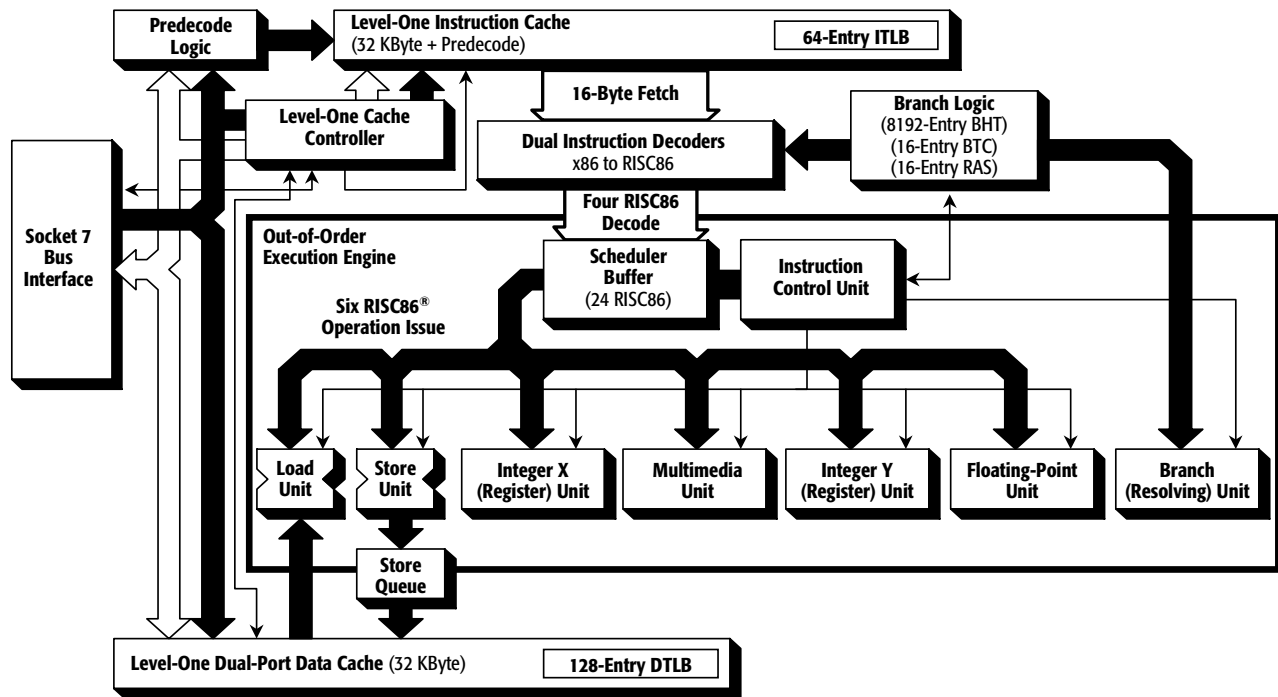

Figure 1. AMD-K6[®] Processor Block Diagram

2.3 Cache, Instruction Prefetch, and Predecode Bits

The writeback level-one cache on the AMD-K6 processor is organized as a separate 32-Kbyte instruction cache and a 32-Kbyte data cache with two-way set associativity. The cache line size is 32 bytes and lines are prefetched from main memory using an efficient pipelined burst transaction. As the instruction cache is filled, each instruction byte is analyzed for instruction boundaries using predecoding logic. Predecoding annotates each instruction byte with information that later enables the decoders to efficiently decode multiple instructions simultaneously.

Cache

The processor cache design takes advantage of a sectored organization (see Figure 2 on page 12). Each sector consists of 64 bytes configured as two 32-byte cache lines. The two cache lines of a sector share a common tag but have separate pairs of MESI (Modified, Exclusive, Shared, Invalid) bits that track the state of each cache line.

Tag Address	Cache Line 1	Byte 31	Predecode Bits	Byte 30	Predecode Bits	Byte 0	Predecode Bits	MESI Bits
	Cache Line 2	Byte 31	Predecode Bits	Byte 30	Predecode Bits	Byte 0	Predecode Bits	MESI Bits

Figure 2. Cache Sector Organization

Two forms of cache misses and associated cache fills can take place—a sector replacement and a cache line replacement. In the case of a sector replacement, the miss is due to a tag mismatch, in which case the required cache line is filled from external memory, and the cache line within the sector that was not required is marked as invalid. In the case of a cache line replacement, the address matches the tag, but the requested cache line is marked as invalid. The required cache line is filled from external memory, and the cache line within the sector that is not required remains in the same cache state.

Prefetching

The AMD-K6 processor performs cache prefetching for sector replacements only—as opposed to cache line replacements. This cache prefetching results in the filling of the required cache line first, and a prefetch of the second cache line. Furthermore, the prefetch of the cache line that is not required is initiated only in the forward direction—that is, only if the requested cache line is the first cache line within the sector. From the perspective of the external bus, the two cache-line fills typically appear as two 32-byte burst read cycles occurring back-to-back or, if allowed, as pipelined cycles.

Predecode Bits

Decoding x86 instructions is particularly difficult because the instructions are variable-length and can be from 1 to 15 bytes long. Predecode logic supplies the predecode bits that are associated with each instruction byte. The predecode bits indicate the number of bytes to the start of the next x86 instruction. The predecode bits are stored in an extended instruction cache alongside each x86 instruction byte as shown in Figure 2 on page 12. The predecode bits are passed with the instruction bytes to the decoders where they assist with parallel x86 instruction decoding.

2.4 Instruction Fetch and Decode

Instruction Fetch

The processor can fetch up to 16 bytes per clock out of the instruction cache or branch target cache. The fetched information is placed into a 16-byte instruction buffer that feeds directly into the decoders (see Figure 3). Fetching can occur along a single execution stream with up to seven outstanding branches taken.

The instruction fetch logic is capable of retrieving any 16 contiguous bytes of information within a 32-byte boundary. There is no additional penalty when the 16 bytes of instructions lie across a cache line boundary. The instruction bytes are loaded into the instruction buffer as they are consumed by the decoders. Although instructions can be consumed with byte granularity, the instruction buffer is managed on a memory-aligned word (2 bytes) organization. Therefore, instructions are loaded and replaced with word granularity. When a control transfer occurs—such as a JMP instruction—the entire instruction buffer is flushed and reloaded with a new set of 16 instruction bytes.

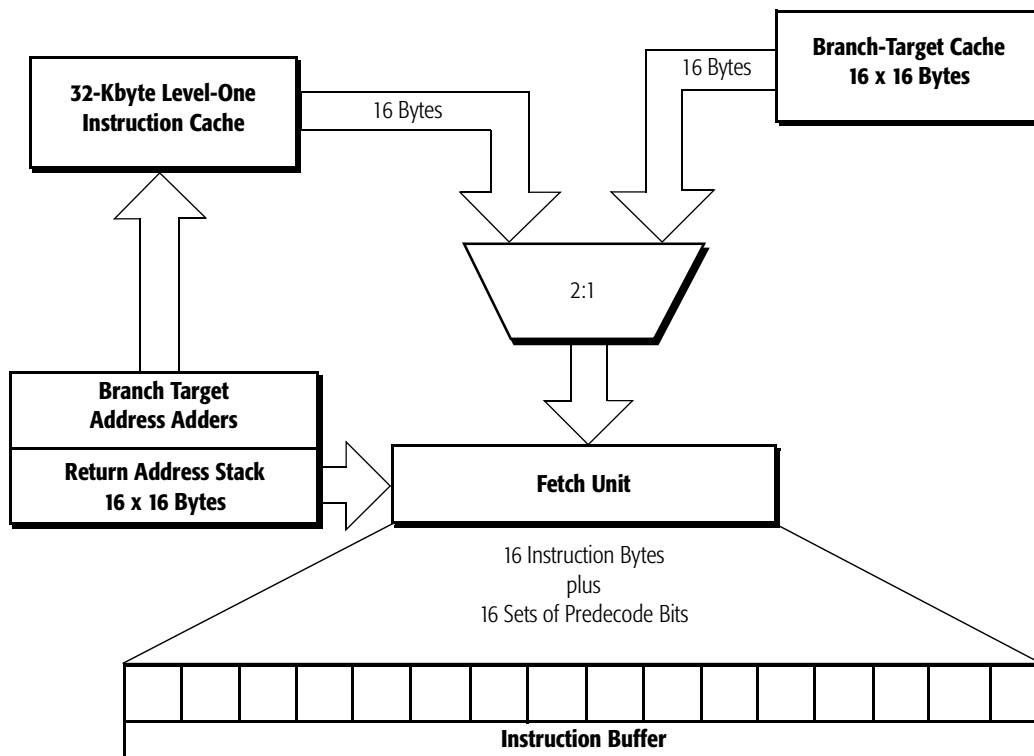

Figure 3. The Instruction Buffer

Instruction Decode

The AMD-K6 processor decode logic is designed to decode multiple x86 instructions per clock (see Figure 4). The decode logic accepts x86 instruction bytes and their predecode bits from the instruction buffer, locates the actual instruction boundaries, and generates RISC86 operations from these x86 instructions.

RISC86 operations are fixed-format internal instructions. Most RISC86 operations execute in a single clock. RISC86 operations are combined to perform every function of the x86 instruction set. Some x86 instructions are decoded into as few as zero RISC86 opcodes—for instance a NOP—or one RISC86 operation—a register-to-register add. More complex x86 instructions are decoded into several RISC86 operations.

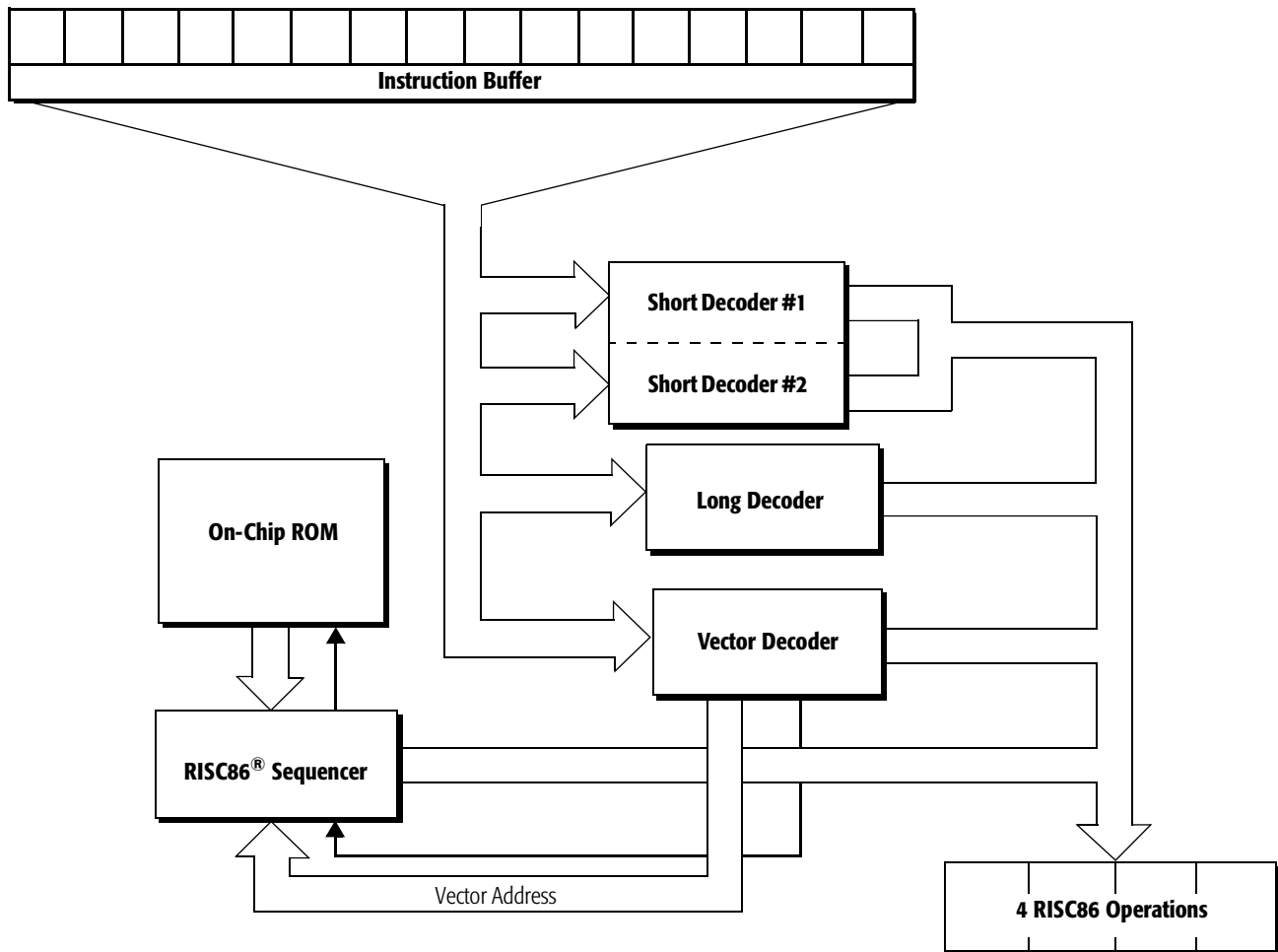

Figure 4. AMD-K6[®] Processor Decode Logic

The AMD-K6 processor uses a combination of decoders to convert x86 instructions into RISC86 operations. The hardware consists of three sets of decoders—two parallel short decoders, one long decoder, and one vectoring decoder. The parallel short decoders translate the most commonly-used x86 instructions (moves, shifts, branches, ALU, MMX, FPU) into zero, one, or two RISC86 operations each. The short decoders only operate on x86 instructions that are up to seven bytes long. In addition, they are designed to decode up to two x86 instructions per clock. The commonly-used x86 instructions that are greater than seven bytes but not more than 11 bytes long, and semi-commonly-used x86 instructions that are up to seven bytes long are handled by the long decoder.

The long decoder only performs one decode per clock and generates up to four RISC86 operations. All other translations (complex instructions, serializing conditions, interrupts and exceptions, etc.) are handled by a combination of the vector decoder and RISC86 operation sequences fetched from an on-chip ROM. For complex operations, the vector decoder logic provides the first set of RISC86 operations and a vector (initial ROM address) to a sequence of further RISC86 operations. The same types of RISC86 operations are fetched from the ROM as those that are generated by the hardware decoders.

***Note:** Although all three sets of decoders are simultaneously fed a copy of the instruction buffer contents, only one of the three types of decoders is used during any one decode clock.*

The decoders or the RISC86 sequencer always generate a group of four RISC86 operations. For decodes that cannot fill the entire group with four RISC86 operations, RISC86 NOP operations are placed in the empty locations of the grouping. For example, a long-decoded x86 instruction that converts to only three RISC86 operations is padded with a single RISC86 NOP operation and then passed to the scheduler. Up to six groups or 24 RISC86 operations can be placed in the scheduler at a time.

All of the common, and a few of the uncommon, floating-point instructions (also known as ESC instructions) are hardware decoded as short decodes. This decode generates a RISC86 floating-point operation and, optionally, an associated floating-point load or store operation. Floating-point or ESC instruction decode is only allowed in the first short decoder, but non-ESC instructions, excluding MMX instructions, can be

decoded simultaneously by the second short decoder along with an ESC instruction decode in the first short decoder.

All of the MMX instructions, with the exception of the EMMS instruction, are hardware decoded as short decodes. The MMX instruction decode generates a RISC86 MMX operation and, optionally, an associated MMX load or store operation. MMX instruction decode is only allowed in the first short decoder. However, instructions other than MMX and ESC instructions can be decoded simultaneously by the second short decoder along with an MMX instruction decode in the first short decoder.

2.5 Centralized Scheduler

The scheduler is the heart of the AMD-K6 processor (see Figure 5 on page 17). It contains the logic necessary to manage out-of-order execution, data forwarding, register renaming, simultaneous issue and retirement of multiple RISC86 operations, and speculative execution. The scheduler's buffer can hold up to 24 RISC86 operations. This equates to a maximum of 12 x86 instructions. When possible, the scheduler can simultaneously issue a RISC86 operation to any available execution unit (store, load, branch, integer, integer/multimedia, or floating-point). In total, the scheduler can issue up to six and retire up to four RISC86 operations per clock.

The main advantage of the scheduler and its operation buffer is the ability to examine an x86 instruction window equal to 12 x86 instructions at one time. This advantage is due to the fact that the scheduler operates on the RISC86 operations in parallel and allows the AMD-K6 processor to perform dynamic on-the-fly instruction code scheduling for optimized execution. Although the scheduler can issue RISC86 operations for out-of-order execution, it always retires x86 instructions in order.

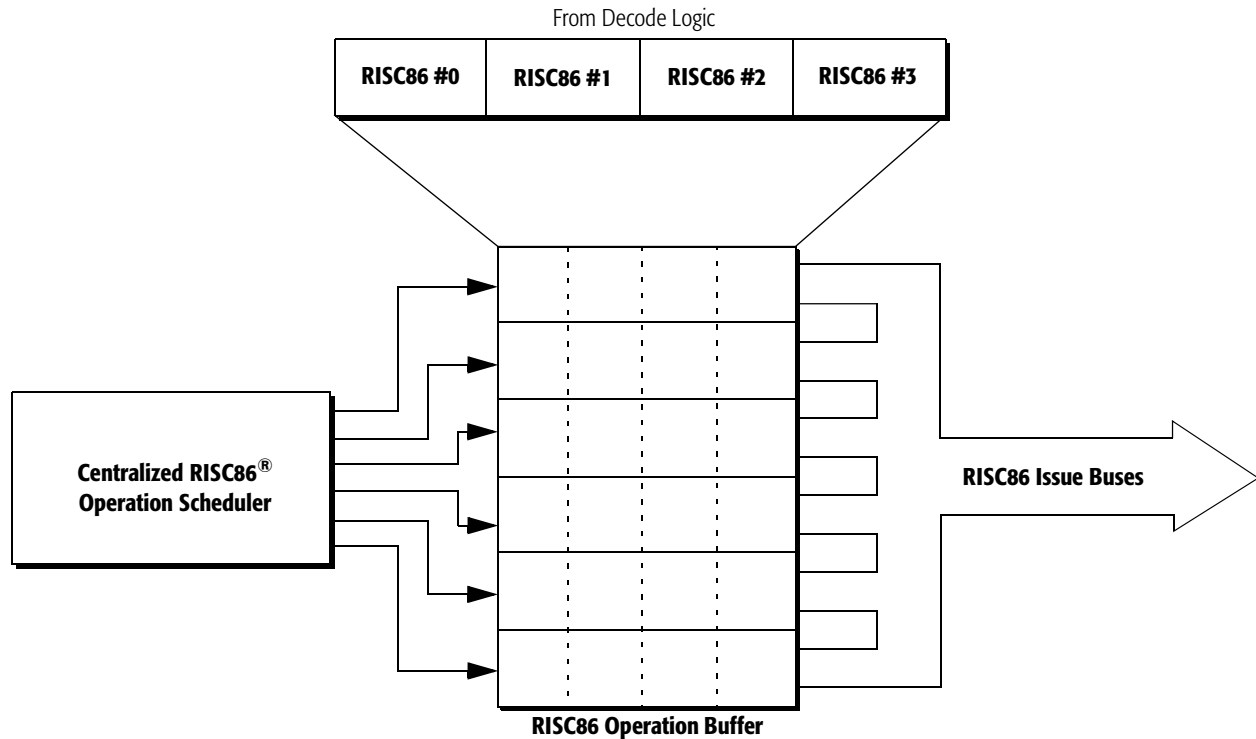

Figure 5. AMD-K6[®] Processor Scheduler

2.6 Execution Units

The AMD-K6 processor contains seven execution units—store, load, integer X, integer Y, multimedia, floating-point, and branch condition. Each unit is independent and capable of handling the RISC86 operations. Table 1 on page 18 details the execution units, functions performed within these units, operation latency, and operation throughput.

The store and load execution units are two-staged pipelined designs. The store unit performs data writes and register calculation for LEA/PUSH. Data memory and register writes from stores are available after one clock. The load unit performs data memory reads. Data is available from the load unit after two clocks.

The Integer X execution unit can operate on all ALU operations, multiplies, divides (signed and unsigned), shifts, and rotates.

The multimedia unit shares pipeline control with the Integer X unit and executes all MMX instructions.

The Integer Y execution unit can operate on the basic word and doubleword ALU operations—ADD, AND, CMP, OR, SUB, XOR, zero-extend and sign-extend operands.

The branch condition unit is separate from the branch prediction logic in that it resolves conditional branches such as JCC and LOOP after the branch condition has been evaluated.

Table 1. Execution Latency and Throughput of Execution Units

Execution Unit	Function	Latency	Throughput
Store	LEA/PUSH, Address	1	1
	Memory Store	1	1
Load	Memory Loads	2	1
Integer X	Integer ALU	1	1
	Integer Multiply	2–3	2–3
	Integer Shift	1	1
Multimedia	MMX ALU	1	1
	MMX Shifts, Packs, Unpack	1	1
	MMX Multiply	1–2	1–2
Integer Y	Basic ALU (16- & 32-bit operands)	1	1
Branch	Resolves Branch Conditions	1	1
FPU	FADD, FSUB, FMUL	2	2

2.7 Branch-Prediction Logic

Sophisticated branch logic that can minimize or hide the impact of changes in program flow is designed into the AMD-K6 processor. Branches in x86 code fit into two categories—unconditional branches, which always change program flow (that is, the branches are always taken) and conditional branches, which may or may not divert program flow (that is, the branches are taken or not-taken). When a conditional branch is not taken, the processor simply continues decoding and executing the next instructions in memory.

Typical applications have up to 10% of unconditional branches and another 10% to 20% conditional branches. The AMD-K6 branch logic has been designed to handle this type of program behavior and its negative effects on instruction execution, such as stalls due to delayed instruction fetching and the draining of the processor pipeline. The branch logic contains an 8192-entry branch history table, a 16-entry by 16-byte branch target cache, a 16-entry return address stack, and a branch execution unit.

Branch History Table

The AMD-K6 processor handles unconditional branches without any penalty by redirecting instruction fetching to the target address of the unconditional branch. However, conditional branches require the use of the dynamic branch-prediction mechanism built into the AMD-K6. A two-level adaptive history algorithm is implemented in an 8192-entry branch history table. This table stores executed branch information, predicts individual branches, and predicts the behavior of groups of branches. To accommodate the large branch history table, the AMD-K6 processor does not store predicted target addresses. Instead, the branch target addresses are calculated on-the-fly using ALUs during the decode stage. The adders calculate all possible target addresses before the instructions are fully decoded and the processor chooses which addresses are valid.

Branch Target Cache

To avoid a one clock cache-fetch penalty when a branch is predicted taken, a built-in branch target cache supplies the first 16 bytes of instructions directly to the instruction buffer (assuming the target address hits this cache). (See Figure 3 on page 13.) The branch target cache is organized as 16 entries of 16 bytes. In total, the branch prediction logic achieves branch prediction rates greater than 95%.

Return Address Stack

The return address stack is a special device designed to optimize CALL and RET pairs. Software is typically compiled with subroutines that are frequently called from various places in a program. This is usually done to save space. Entry into the subroutine occurs with the execution of a CALL instruction. At that time, the processor pushes the address of the next instruction in memory following the CALL instruction onto the stack (allocated space in memory). When the processor encounters a RET instruction (within or at the end of the subroutine), the branch logic pops the address from the stack and begins fetching from that location. To avoid the latency of main memory accesses during CALL and RET operations, the return address stack caches the pushed addresses.

Branch Execution Unit

The branch execution unit enables efficient speculative execution. This unit gives the processor the ability to execute instructions beyond conditional branches before knowing whether the branch prediction was correct. The AMD-K6 processor does not permanently update the x86 registers or memory locations until all speculatively executed conditional branch instructions are resolved. When a prediction is incorrect, the processor backs out to the point of the mispredicted branch instruction and restores all registers. The AMD-K6 can support up to seven outstanding branches.

3 Software Environment

This chapter provides a general overview of the AMD-K6 processor's x86 software environment and briefly describes the data types, registers, operating modes, interrupts, and instructions supported by the AMD-K6 architecture and design implementation.

3.1 Registers

The AMD-K6 processor contains all the registers defined by the x86 architecture, including general-purpose, segment, floating-point, MMX, EFLAGS, control, task, debug, test, and descriptor/memory-management registers. In addition, this chapter provides information on the AMD-K6 Model-Specific Registers (MSRs).

Note: Areas of the register designated as Reserved should not be modified by software.

General-Purpose Registers

The eight 32-bit x86 general-purpose registers are used to hold integer data or memory pointers used by instructions. Table 2 contains a list of the general-purpose registers and the functions for which they are used.

Table 2. General-Purpose Registers

Register	Function
EAX	Commonly used as an accumulator
EBX	Commonly used as a pointer
ECX	Commonly used for counting in loop operations
EDX	Commonly used to hold I/O information and to pass parameters
EDI	Commonly used as a destination pointer by the ES segment
ESI	Commonly used as a source pointer by the DS segment
ESP	Used to point to the stack segment
EBP	Used to point to data within the stack segment

In order to support byte and word operations, EAX, EBX, ECX, and EDX can also be used as 8-bit and 16-bit registers. The shorter registers are overlaid on the longer ones. For example, the name of the 16-bit version of EAX is AX (low 16 bits of EAX) and the 8-bit names for AX are AH (high order bits) and

AL (low order bits). The same naming convention applies to EBX, ECX, and EDX. EDI, ESI, ESP, and EBP can be used as smaller 16-bit registers called DI, SI, SP, and BP respectively, but these registers do not have 8-bit versions. Figure 6 shows the EAX register with its name components, and Table 3 lists the dword (32 bits) general-purpose registers and their corresponding word (16 bits) and byte (8 bits) versions.

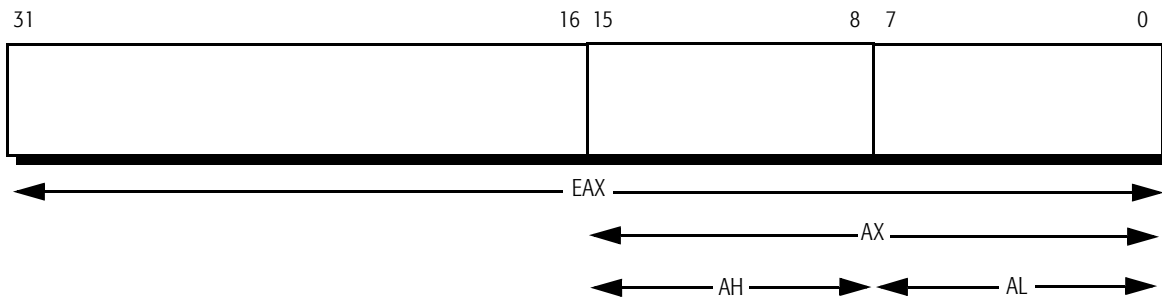

Figure 6. EAX Register with 16-Bit and 8-Bit Name Components

Table 3. General-Purpose Register Dword, Word, and Byte Names

32-Bit Name (Dword)	16-Bit Name (Word)	8-Bit Name (High-order Bits)	8-Bit Name (Low-order Bits)
EAX	AX	AH	AL
EBX	BX	BH	BL
ECX	CX	CH	CL
EDX	DX	DH	DL
EDI	DI	–	–
ESI	SI	–	–
ESP	SP	–	–
EBP	BP	–	–

Integer Data Types

Four types of data are used in general-purpose registers—byte, word, doubleword, and quadword integers. Figure 7 shows the format of the integer data registers.

Byte Integer

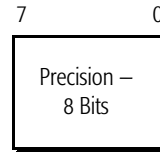

Word Integer

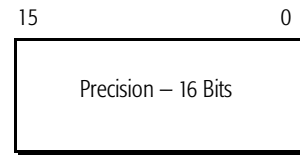

Doubleword Integer



Quadword Integer



Figure 7. Integer Data Types

Segment Registers

The six 16-bit segment registers are used as pointers to areas (segments) of memory. Table 4 lists the segment registers and their functions. Figure 8 shows the format for all six segment registers.

Table 4. Segment Registers

Segment Register	Segment Register Function
CS	Code segment, where instructions are located
DS	Data segment, where data is located
ES	Data segment, where data is located
FS	Data segment, where data is located
GS	Data segment, where data is located
SS	Stack segment

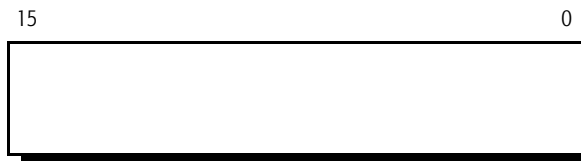

Figure 8. Segment Register

Segment Usage

The operating system determines the type of memory model that is implemented. The segment register usage is determined by the operating system's memory model. In a Real mode memory model the segment register points to the base address in memory. In a Protected mode memory model the segment register is called a selector and it selects a segment descriptor in a descriptor table. This descriptor contains a pointer to the base of the segment, the limit of the segment, and various protection attributes. For more information on descriptor formats, see "Descriptors and Gates" on page 45. Figure 9 on page 25 shows segment usage for Real mode and Protected mode memory models.

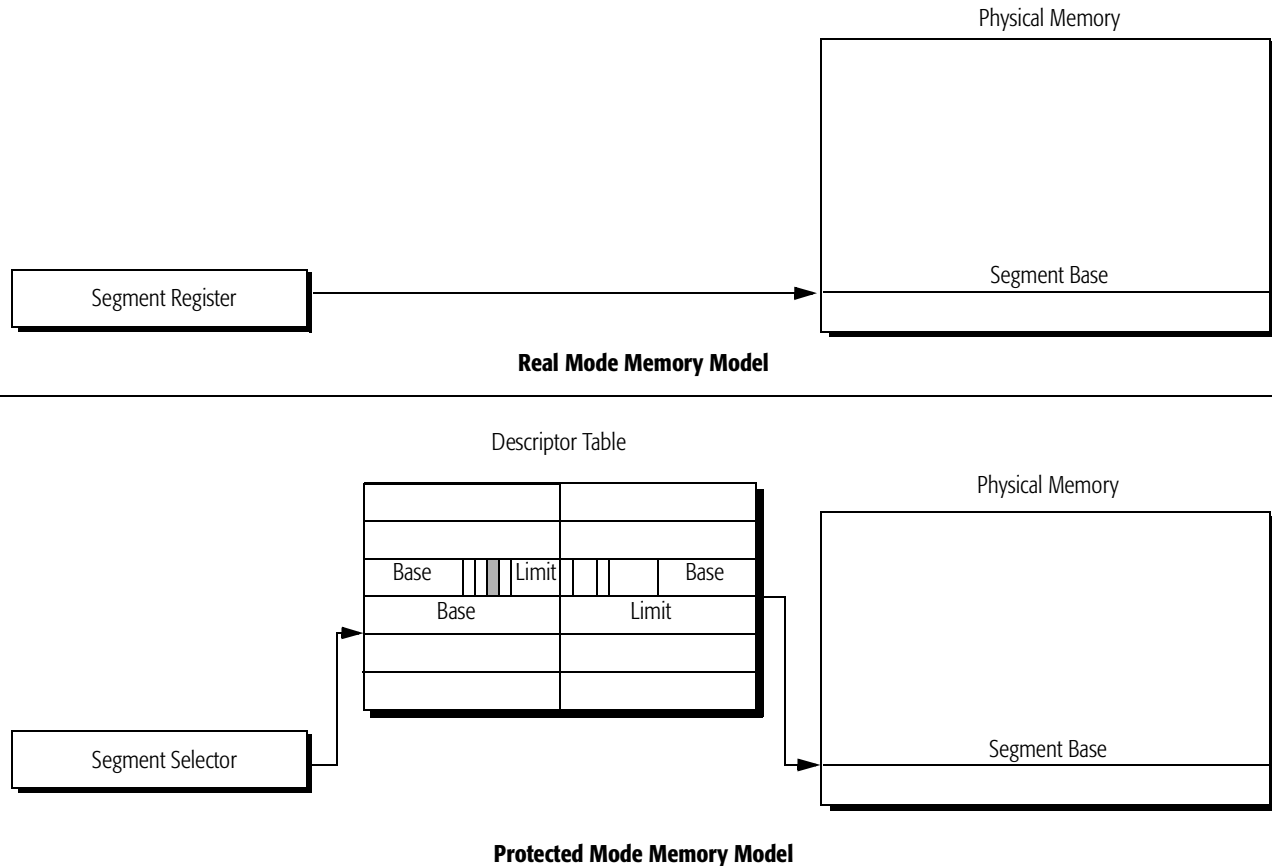

Figure 9. Segment Usage

Instruction Pointer

The instruction pointer (EIP or IP) is used in conjunction with the code segment register (CS). The instruction pointer is either a 32-bit register (EIP) or a 16-bit register (IP) that keeps track of where the next instruction resides within memory. This register cannot be directly manipulated, but can be altered by modifying return pointers when a JMP or CALL instruction is used.

Floating-Point Registers

The floating-point execution unit in the AMD-K6 processor is designed to perform mathematical operations on non-integer numbers. This floating-point unit conforms to the IEEE 754 and 854 standards and uses several registers to meet these standards—eight numeric floating-point registers, a status word register, a control word register, and a tag word register.

The eight floating-point registers are 80 bits wide and labeled FPR0–FPR7. Figure 10 shows the format of these floating-point registers. See “Floating-Point Register Data Types” on page 28 for information on allowable floating-point data types.

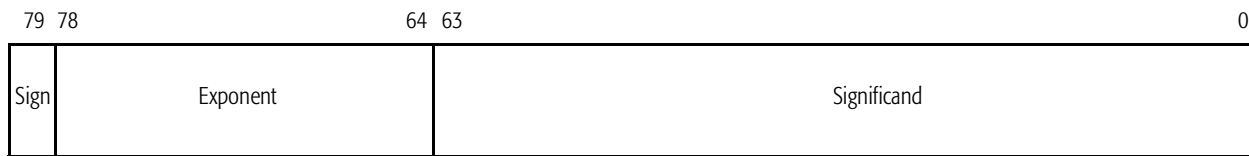

Figure 10. Floating-Point Register

The 16-bit FPU status word register contains information about the state of the floating-point unit. Figure 11 shows the format of this register.

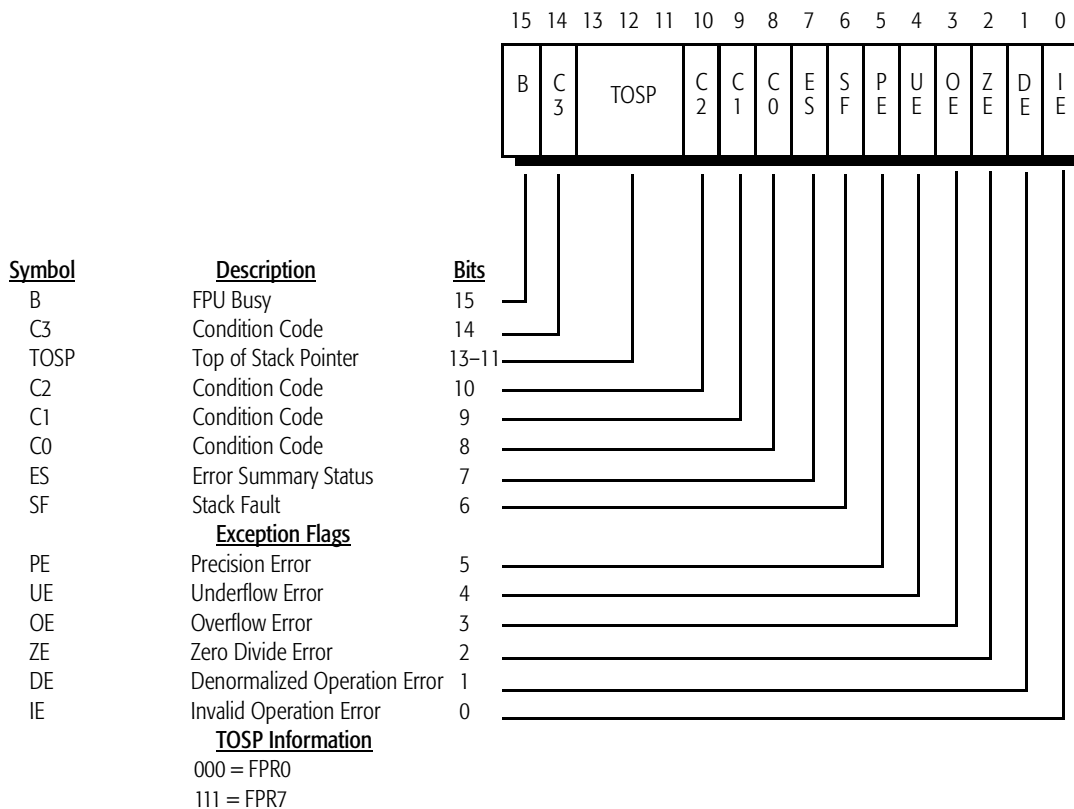

Figure 11. FPU Status Word Register

The FPU control word register allows a programmer to manage the FPU processing options. Figure 12 shows the format of this register.

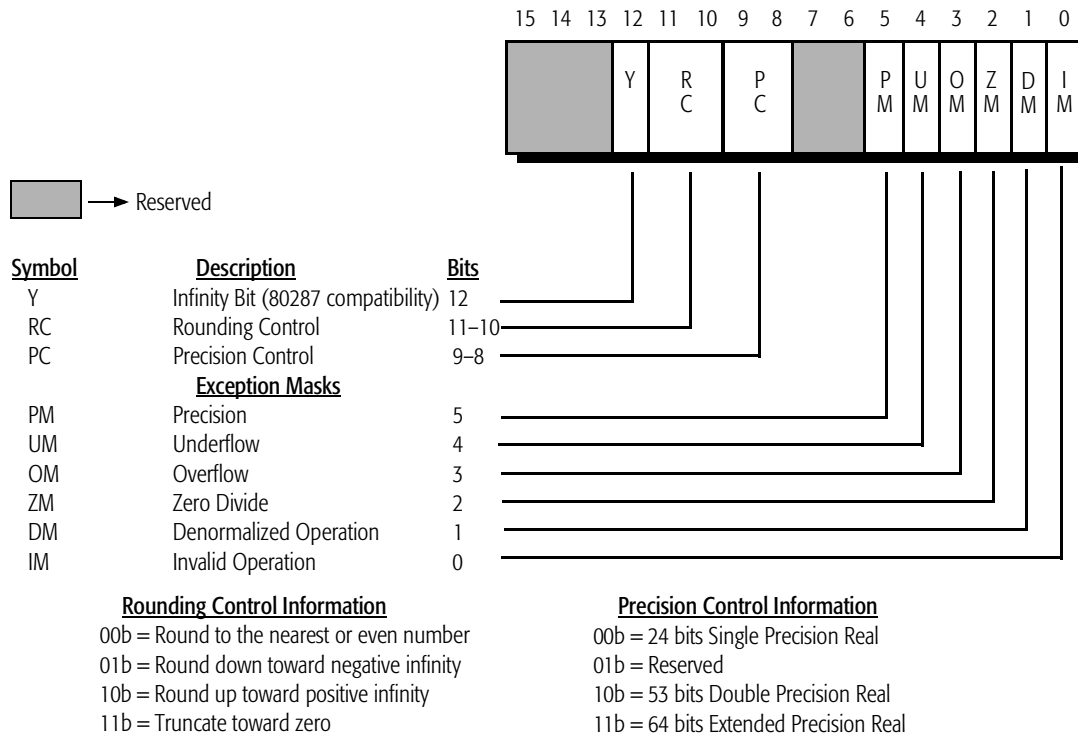

Figure 12. FPU Control Word Register

The FPU tag word register contains information about the registers in the register stack. Figure 13 shows the format of this register.

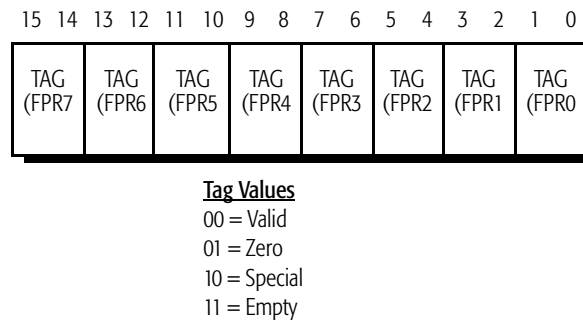

Figure 13. FPU Tag Word Register

Floating-Point Register Data Types

Floating-point registers use four different types of data—packed decimal, single precision real, double precision real, and extended precision real. Figures 14 and 15 show the formats for these registers.

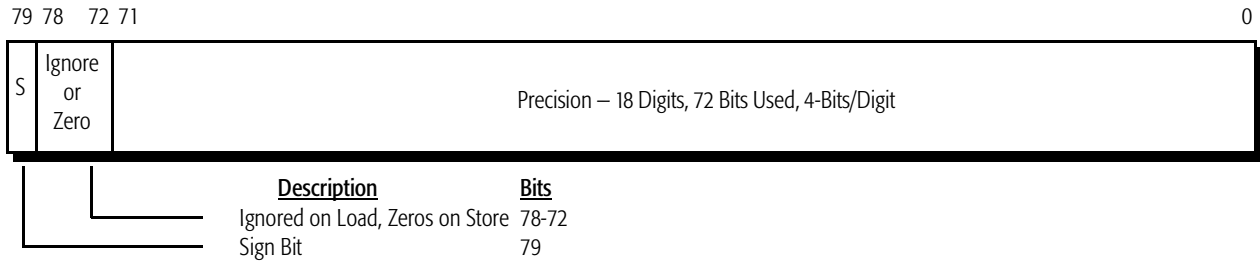

Figure 14. Packed Decimal Data Type

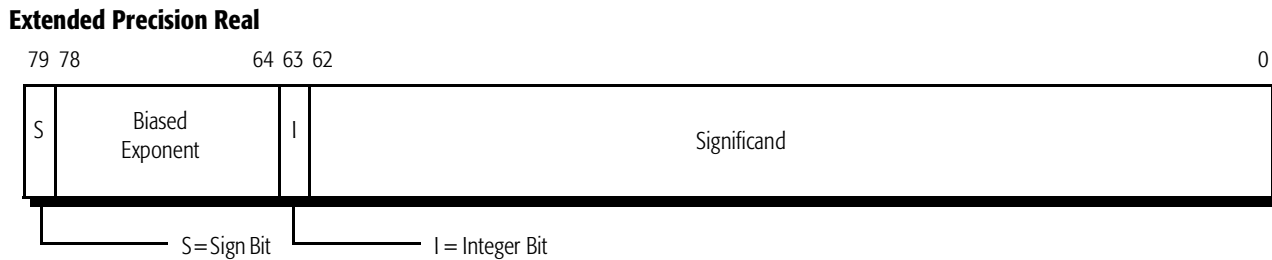
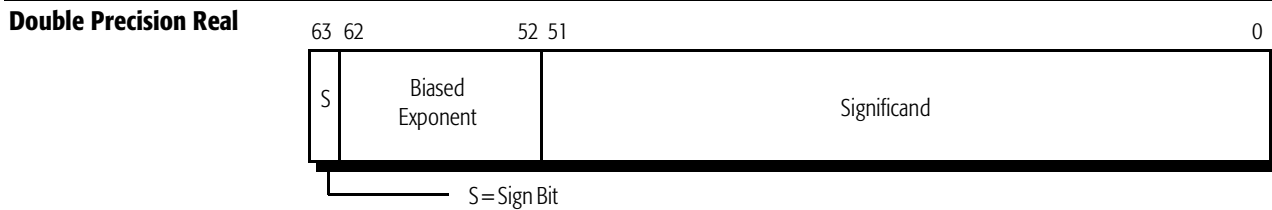
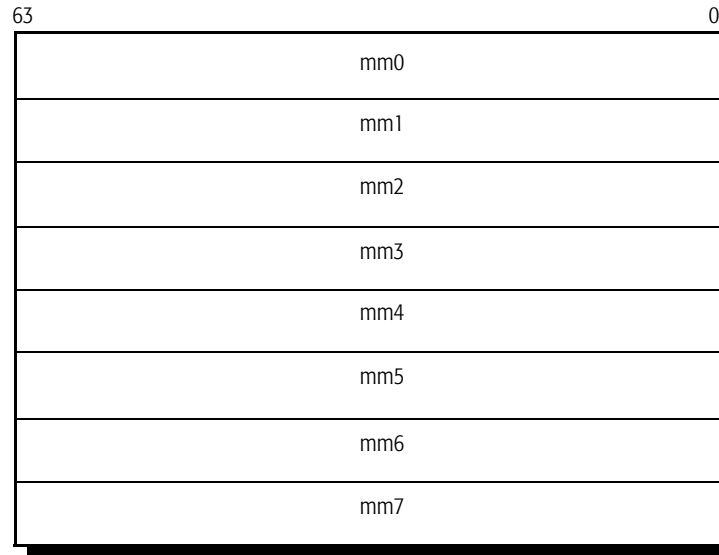

Figure 15. Precision Real Data Types

MMX™ Registers

The AMD-K6 processor implements eight 64-bit MMX registers and three packed data types for use by multimedia software. These registers are mapped on the floating-point registers. The MMX instructions refer to these registers as mm0 to mm7. Figures 16 and 17 show the format of these registers and data types. See *AMD-K6[®] Processor Multimedia Technology*, order# 20726 for more information.

**Figure 16. MMX™ Registers**

Packed Bytes

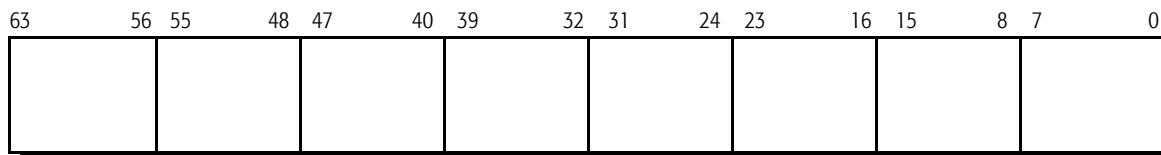

Packed Words

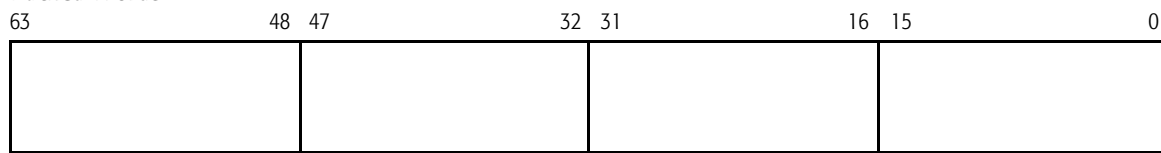

Packed Doublewords

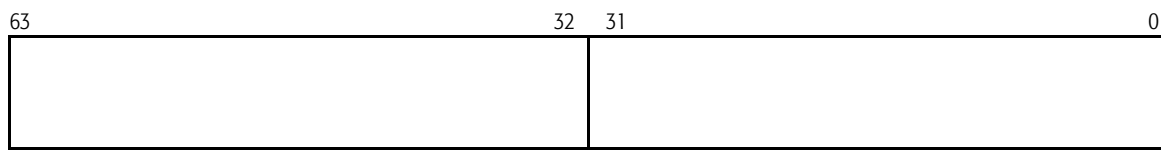

Figure 17. MMX™ Data Types

EFLAGS Register

The EFLAGS register provides for three different types of flags—system, control, and status. The system flags provide operating system controls, the control flag provides directional information for string operations, and the status flags provide information resulting from logical and arithmetic operations. Figure 18 shows the format of this register.

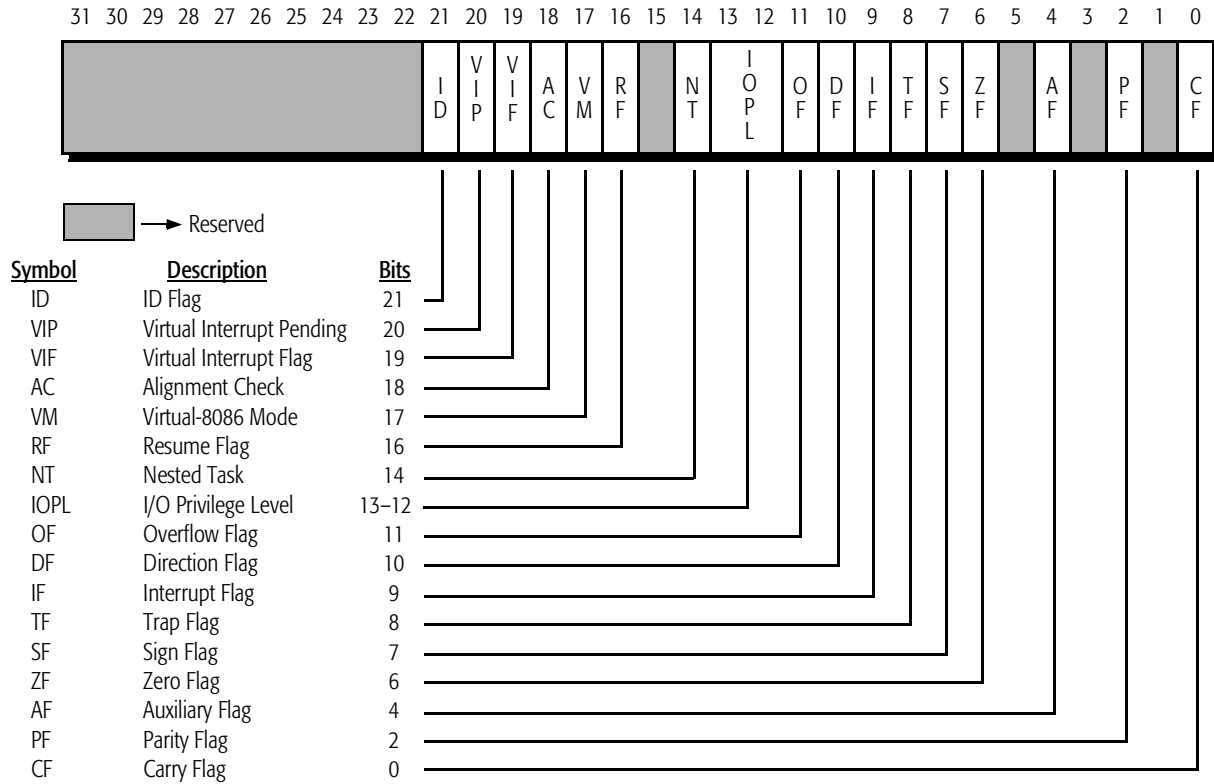

Figure 18. EFLAGS Registers

Control Registers

The five control registers contain system control bits and pointers. Figures 19 through 23 show the formats of these registers.

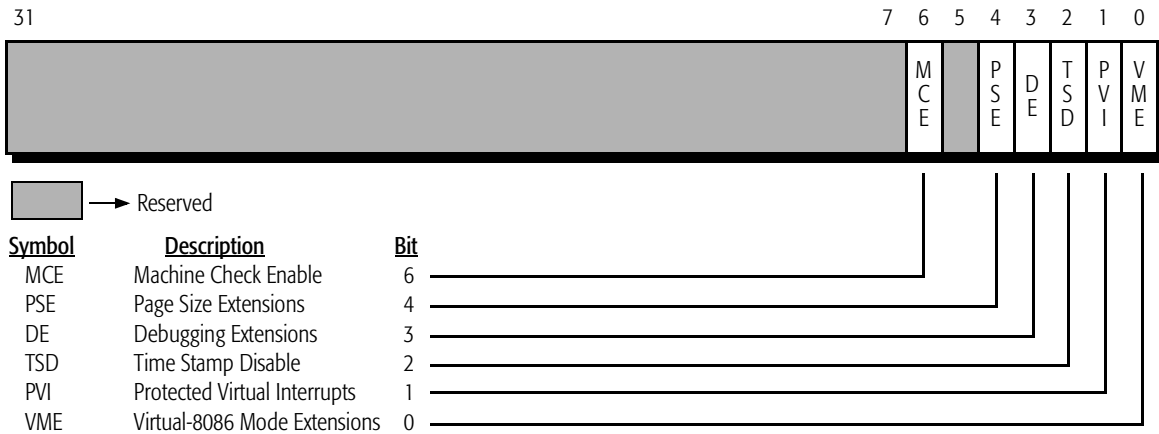

Figure 19. Control Register 4 (CR4)

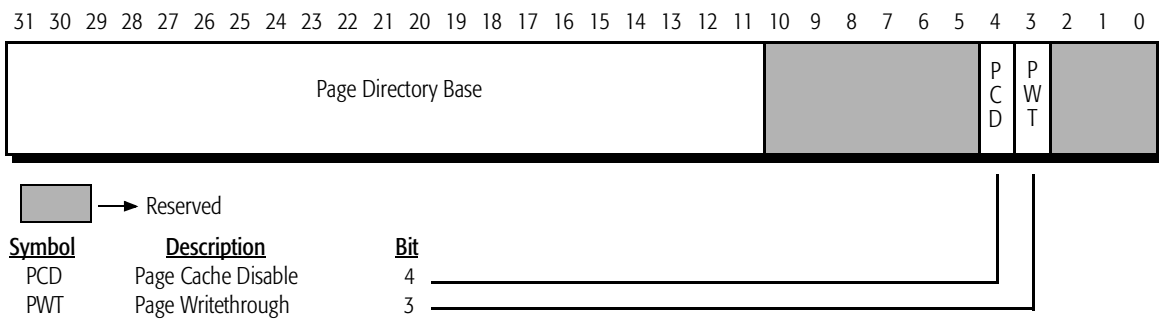

Figure 20. Control Register 3 (CR3)



Figure 21. Control Register 2 (CR2)



Figure 22. Control Register 1 (CR1)

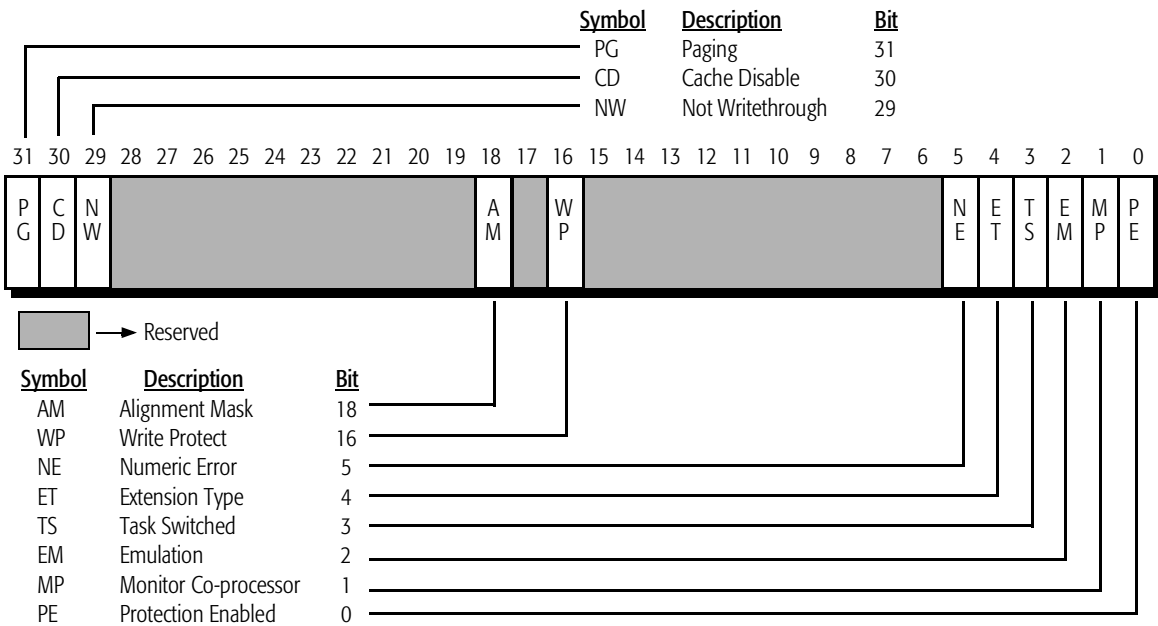

Figure 23. Control Register 0 (CR0)

Debug Registers

Figures 24 through 27 show the 32-bit debug registers supported by the processor.

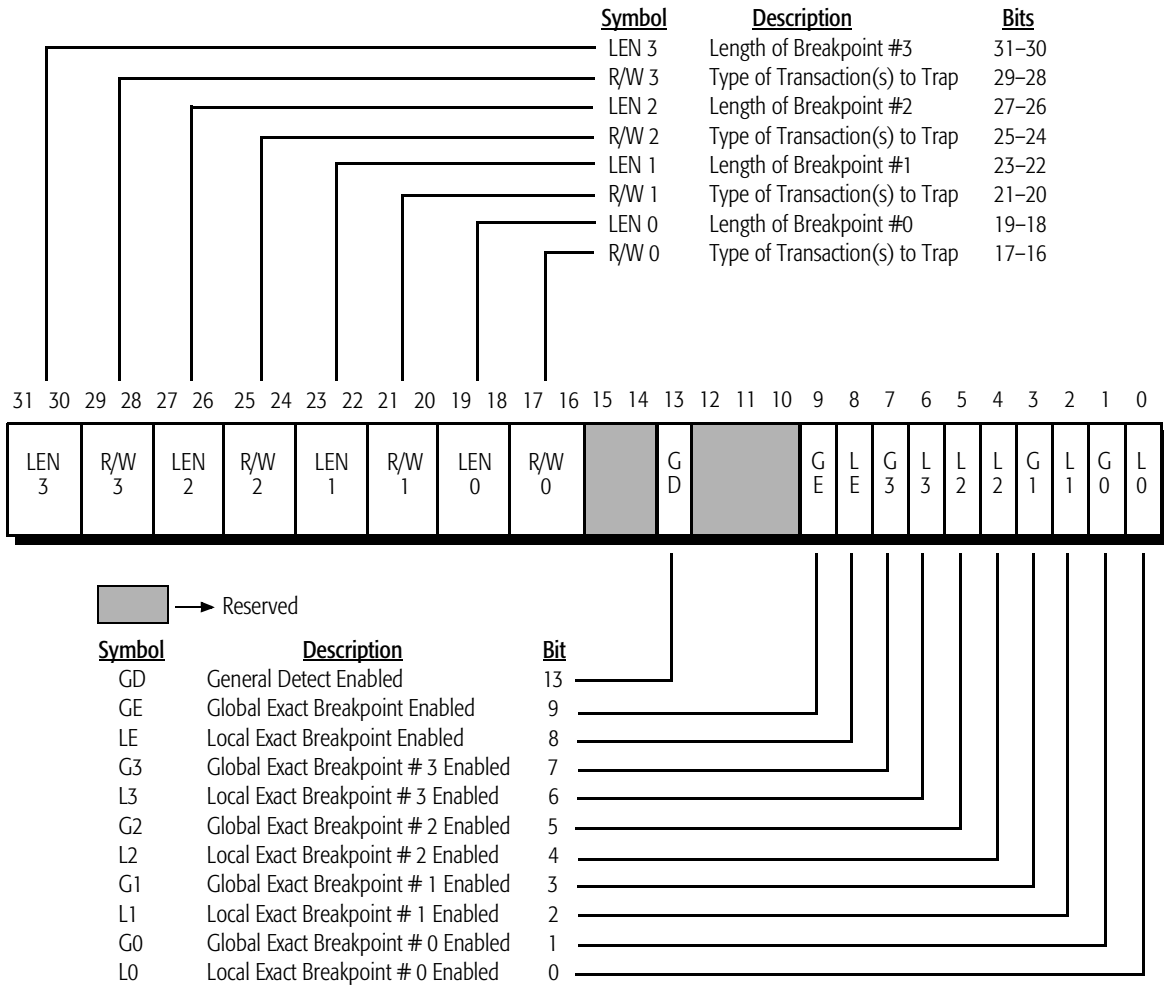

Figure 24. Debug Register DR7

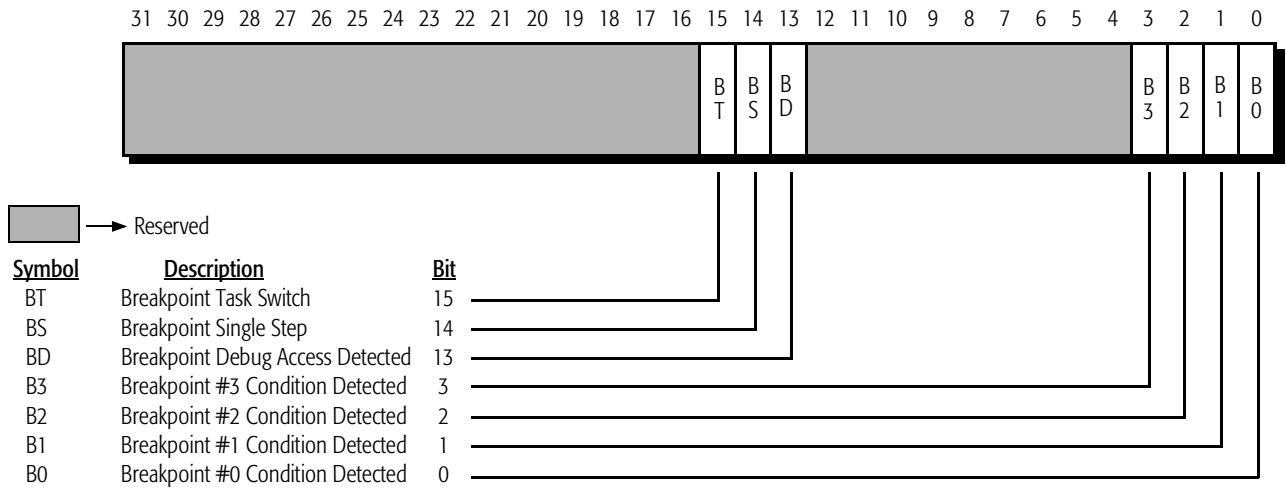

Figure 25. Debug Register DR6

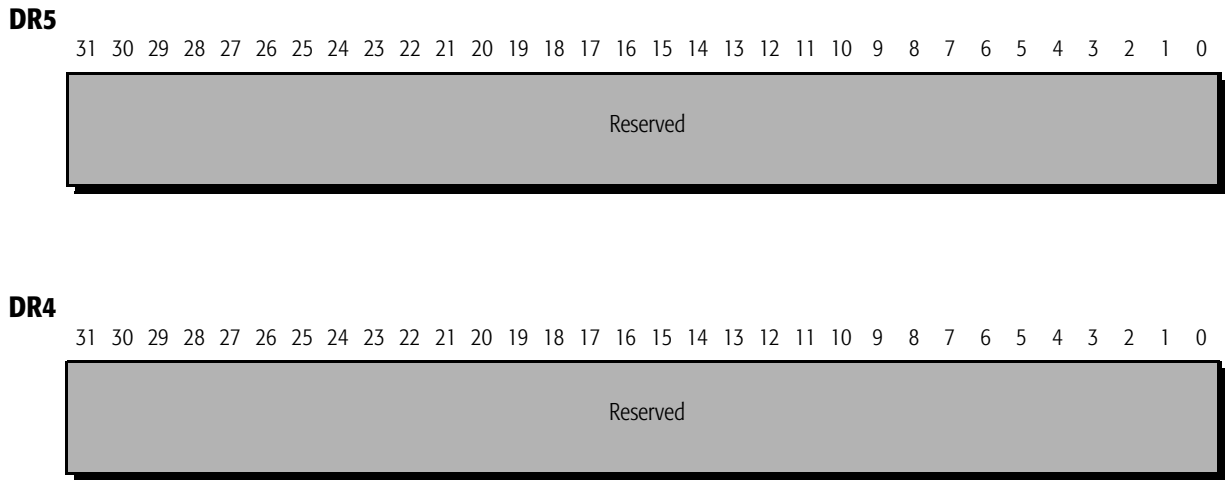

Figure 26. Debug Registers DR5 and DR4

DR3

31 30 29 28 27 26 25 24 23 22 21 20 19 18 17 16 15 14 13 12 11 10 9 8 7 6 5 4 3 2 1 0

Breakpoint 3 32-bit Linear Address

DR2

31 30 29 28 27 26 25 24 23 22 21 20 19 18 17 16 15 14 13 12 11 10 9 8 7 6 5 4 3 2 1 0

Breakpoint 2 32-bit Linear Address

DR1

31 30 29 28 27 26 25 24 23 22 21 20 19 18 17 16 15 14 13 12 11 10 9 8 7 6 5 4 3 2 1 0

Breakpoint 1 32-bit Linear Address

DR0

31 30 29 28 27 26 25 24 23 22 21 20 19 18 17 16 15 14 13 12 11 10 9 8 7 6 5 4 3 2 1 0

Breakpoint 0 32-bit Linear Address

Figure 27. Debug Registers DR3, DR2, DR1, and DR0

Model-Specific Registers (MSR)

The AMD-K6 processor provides five MSRs. The value in the ECX register selects the MSR to be addressed by the RDMSR and WRMSR instructions. The values in EAX and EDX are used as inputs and outputs by the RDMSR and WRMSR instructions. Table 5 lists the MSRs and the corresponding value of the ECX register. Figures 28 through 32 show the MSR formats.

Table 5. Model-Specific Registers (MSRs)

Model-Specific Register	Value of ECX
Machine Check Address Register (MCAR)	00h
Machine Check Type Register (MCTR)	01h
Test Register 12 (TR12)	0Eh
Time Stamp Counter (TSC)	10h
Write Handling Control Register (WHCR)	C000_0082h

For more information about the RDMSR and WRMSR instructions, see the *AMD K86™ Family BIOS and Software Tools Development Guide*, order# 21062.

MCAR and MCTR. The AMD-K6 processor does not support the generation of a machine check exception. However, the processor does provide a 64-bit Machine Check Address Register (MCAR), a 64-bit Machine Check Type Register (MCTR), and a Machine Check Enable (MCE) bit in CR4. Because the processor does not support machine check exceptions, the contents of the MCAR and MCTR are only affected by the WRMSR instruction and by RESET being sampled asserted (where all bits in each register are reset to 0).

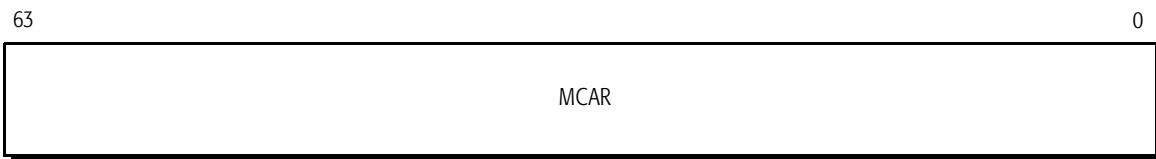

Figure 28. Machine-Check Address Register (MCAR)

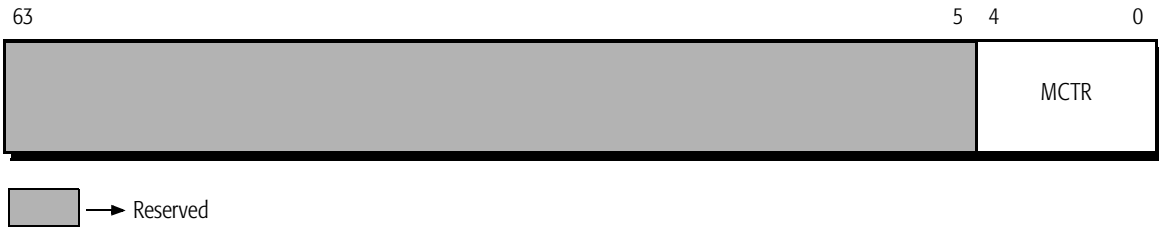

Figure 29. Machine-Check Type Register (MCTR)

Test Register 12 (TR12). Test register 12 provides a method for disabling the L1 caches. Figure 30 shows the format of TR12.

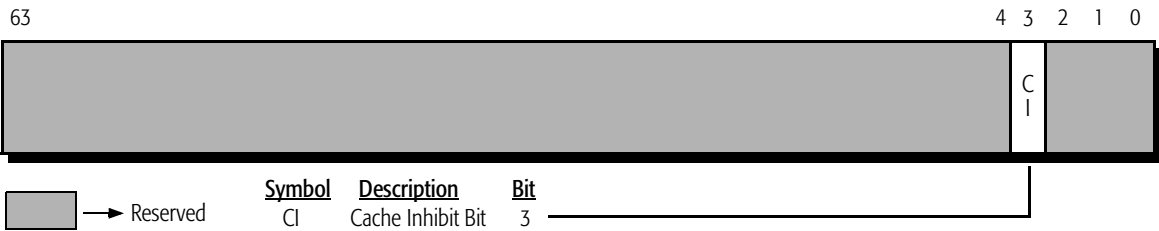

Figure 30. Test Register 12 (TR12)

Time Stamp Counter. With each processor clock cycle, the processor increments the 64-bit time stamp counter (TSC) MSR. Figure 31 shows the format of the TSC.

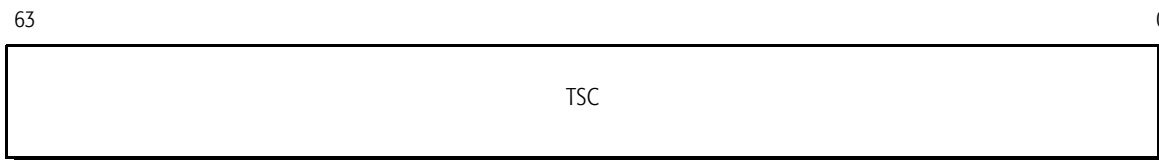
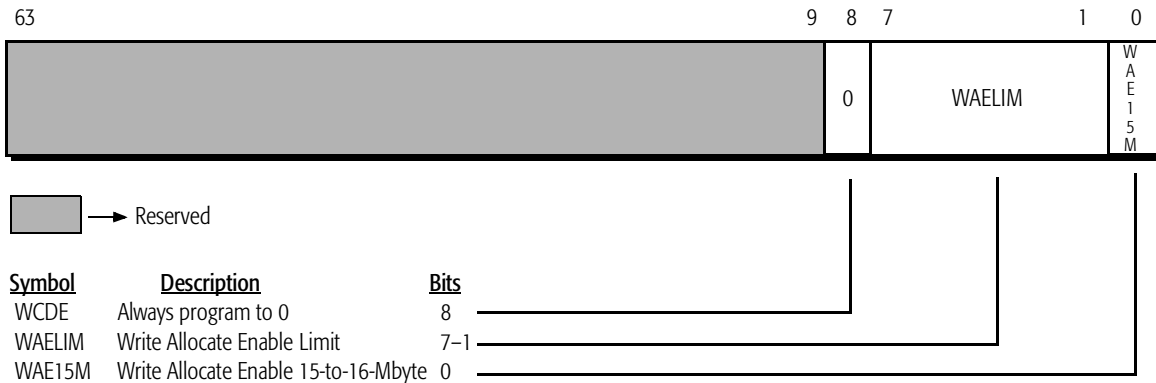

Figure 31. Time Stamp Counter (TSC)

Write Handling Control Register (WHCR). The Write Handling Control Register (WHCR) is a MSR that contains three fields—the WCDE bit, Write Allocate Enable Limit (WAE LIM) field, and the Write Allocate Enable 15-to-16-Mbyte (WAE15M) bit. Figure 32 shows the format of WHCR. See “Write Allocate” on page 177 for more information.



Note: Hardware RESET initializes this MSR to all zeros.

Figure 32. Write Handling Control Register (WHCR)

Memory Management Registers

The AMD-K6 processor controls segmented memory management with the registers listed in Table 6. Figure 33 on page 40 shows the formats of these registers.

Table 6. Memory Management Registers

Register Name	Function
Global Descriptor Table Register	Contains a pointer to the base of the Global Descriptor Table
Interrupt Descriptor Table Register	Contains a pointer to the base of the Interrupt Descriptor Table
Local Descriptor Table Register	Contains a pointer to the Local Descriptor Table of the current task
Task Register	Contains a pointer to the Task State Segment of the current task

Global and Interrupt Descriptor Table Registers



Local Descriptor Table Register and Task Register

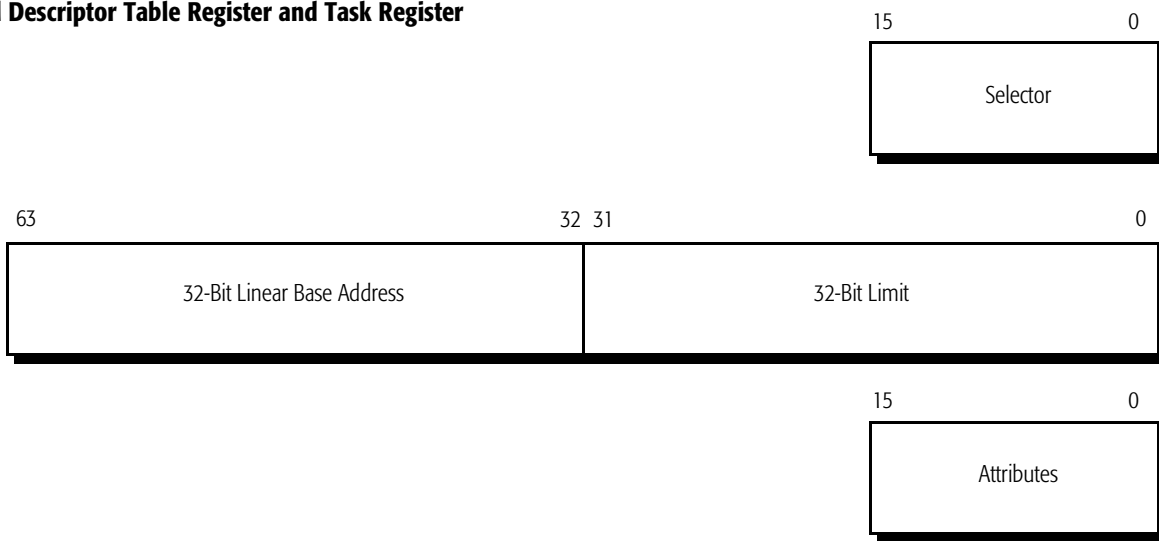

Figure 33. Memory Management Registers

Task State Segment

Figure 34 shows the format of the Task State Segment (TSS).

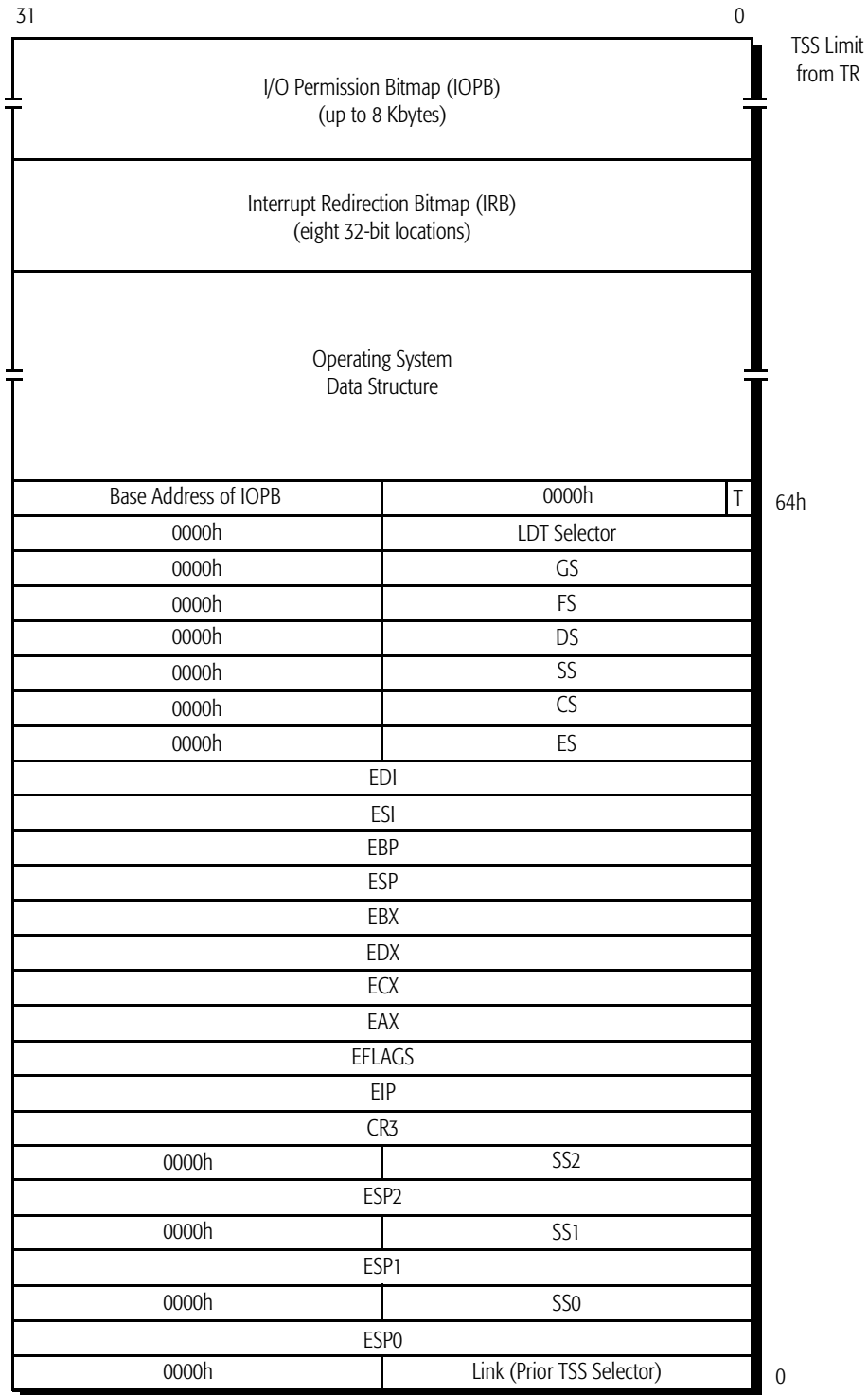

Figure 34. Task State Segment (TSS)

Paging

The AMD-K6 processor can address up to 4 Gbytes of memory. This memory can be segmented into pages. The size of these pages is determined by the operating system design and the values set up in the Page Directory Entries (PDE) and Page Table Entries (PTE). The processor can access both 4-Kbyte pages and 4-Mbyte pages, and the page sizes can be intermixed within a page directory. When the Page Size Extension (PSE) bit in CR4 is set, the processor translates linear addresses using either the 4-Kbyte Translation Lookaside Buffer (TLB) or the 4-Mbyte TLB, depending on the state of the page size (PS) bit in the page directory entry. Figures 35 and 36 show how 4-Kbyte and 4-Mbyte page translations work.

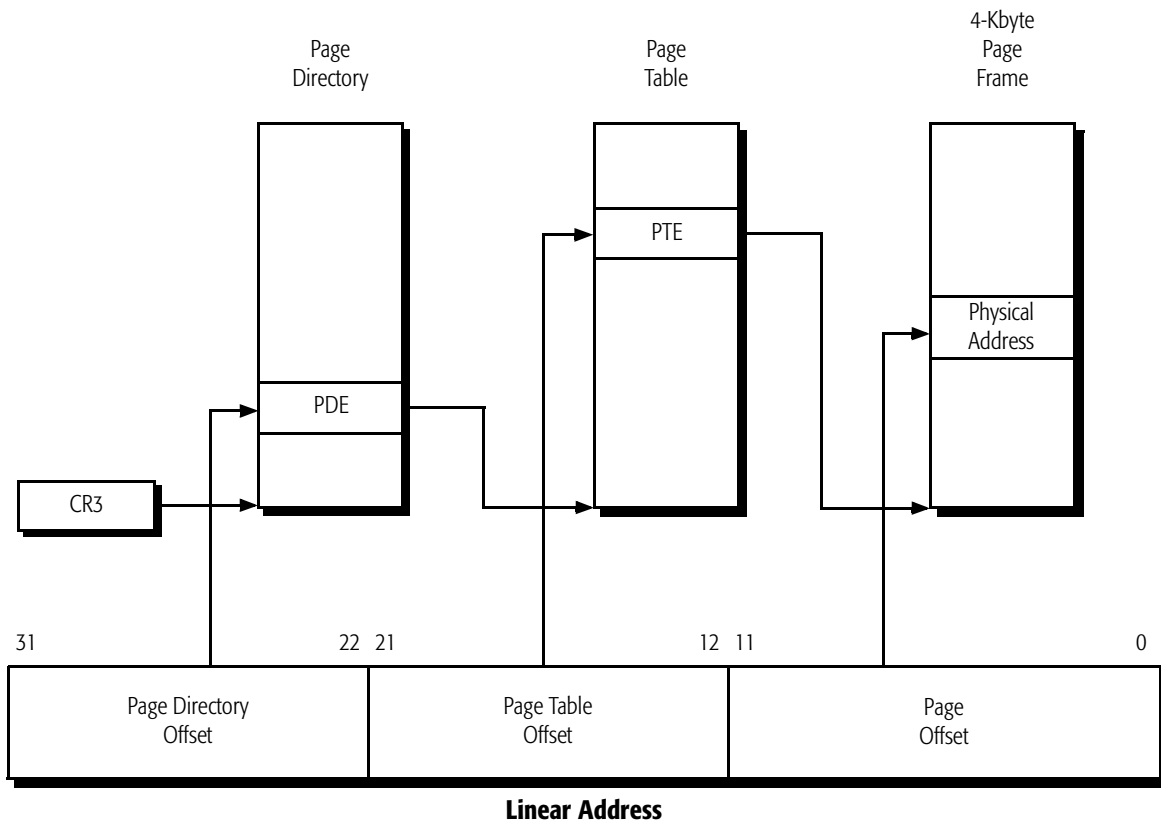

Figure 35. 4-Kbyte Paging Mechanism

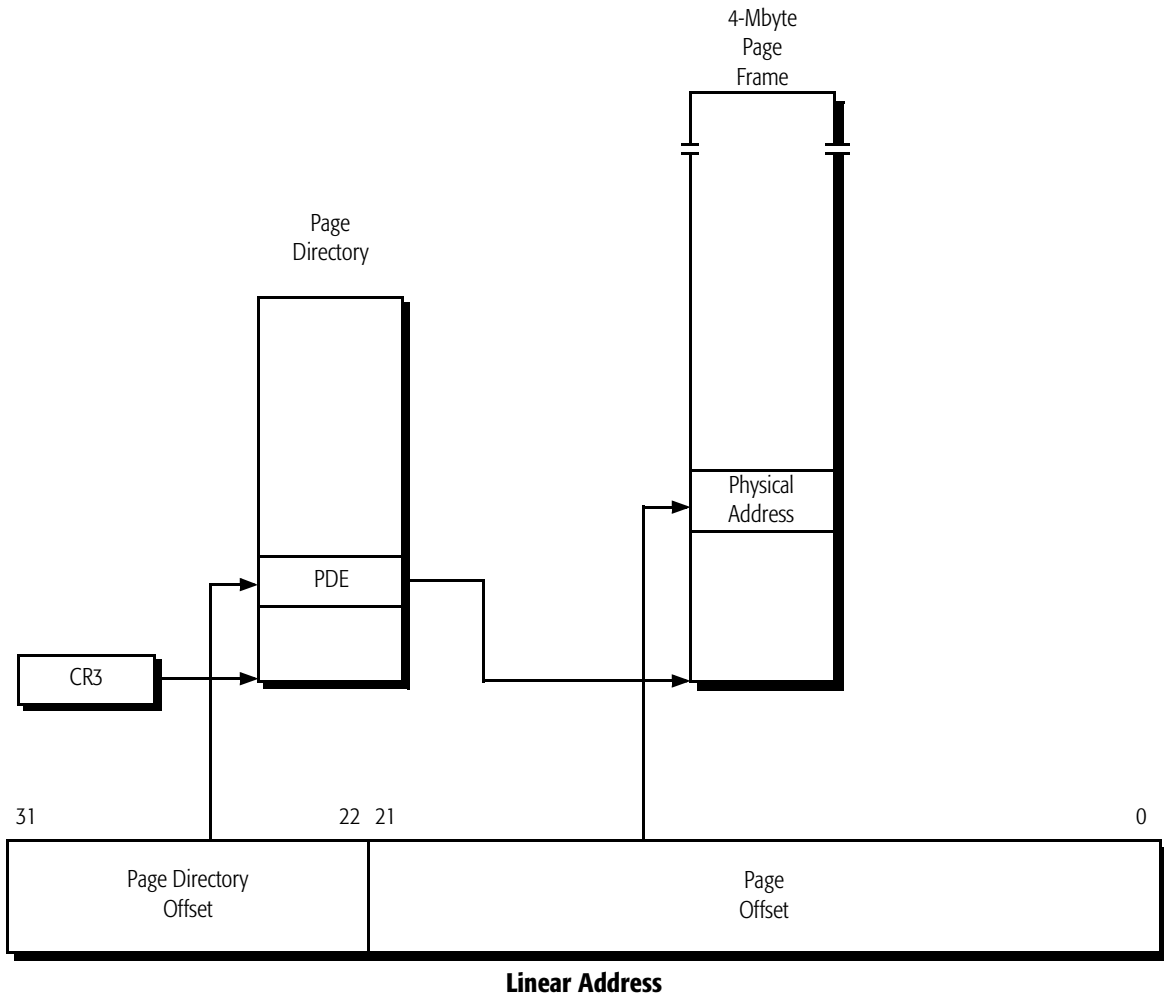

Figure 36. 4-Mbyte Paging Mechanism

Figures 37 through 39 show the formats of the PDE and PTE. These entries contain information regarding the location of pages and their status.

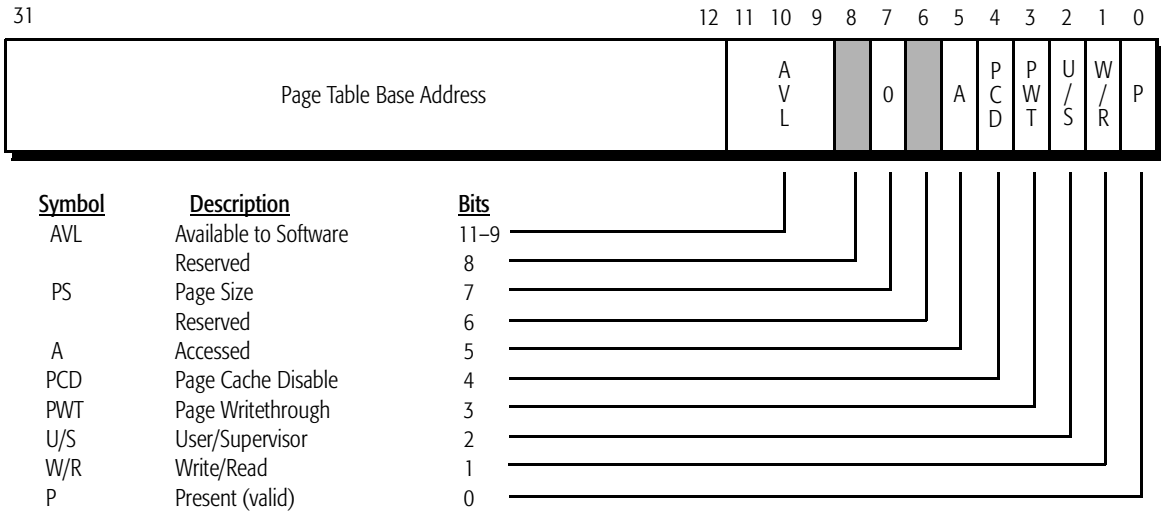

Figure 37. Page Directory Entry 4-Kbyte Page Table (PDE)

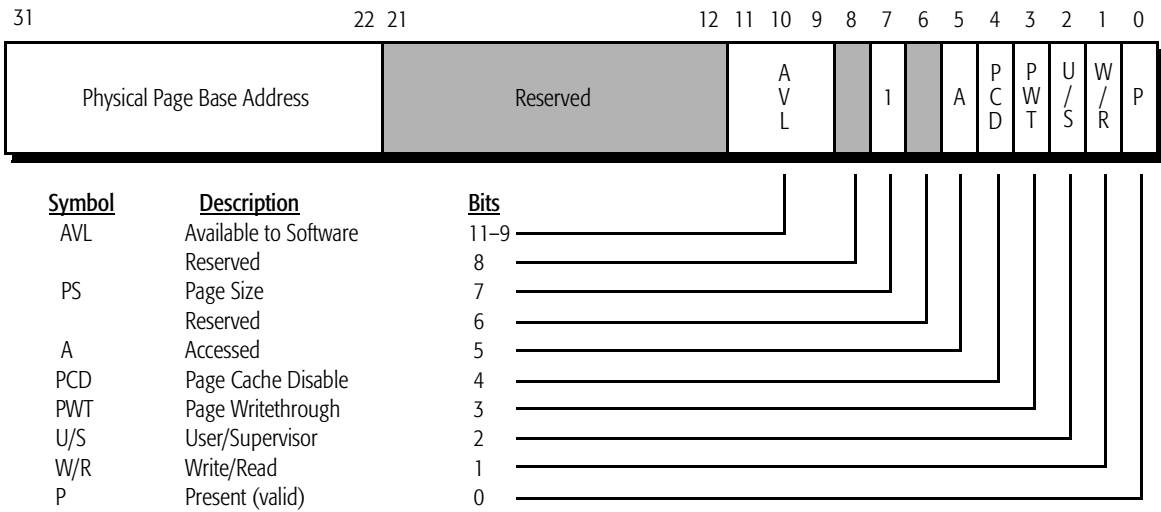

Figure 38. Page Directory Entry 4-Mbyte Page Table (PDE)

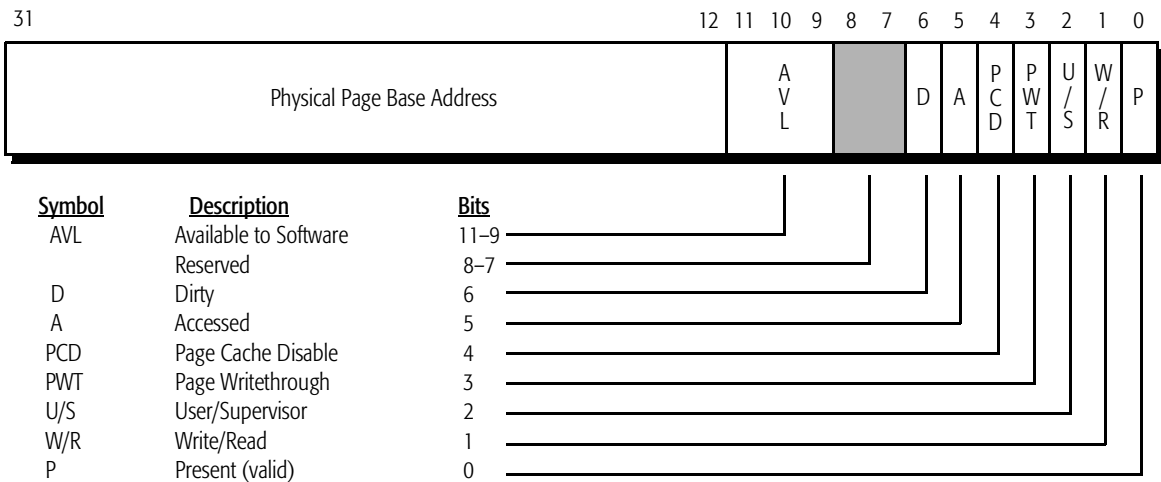

Figure 39. Page Table Entry (PTE)

Descriptors and Gates

There are various types of structures and registers in the x86 architecture that define, protect, and isolate code segments, data segments, task state segments, and gates. These structures are called descriptors.

Figure 40 on page 46 shows the application segment descriptor format. Table 7 contains information describing the memory segment type to which the descriptor points. The application segment descriptor is used to point to either a data or code segment.

Figure 41 on page 47 shows the system segment descriptor format. Table 8 contains information describing the type of segment or gate to which the descriptor points. The system segment descriptor is used to point to a task state segment, a call gate, or a local descriptor table.

The AMD-K6 processor uses gates to transfer control between executable segments with different privilege levels. Figure 42 on page 48 shows the format of the gate descriptor types. Table 8 contains information describing the type of segment or gate to which the descriptor points.

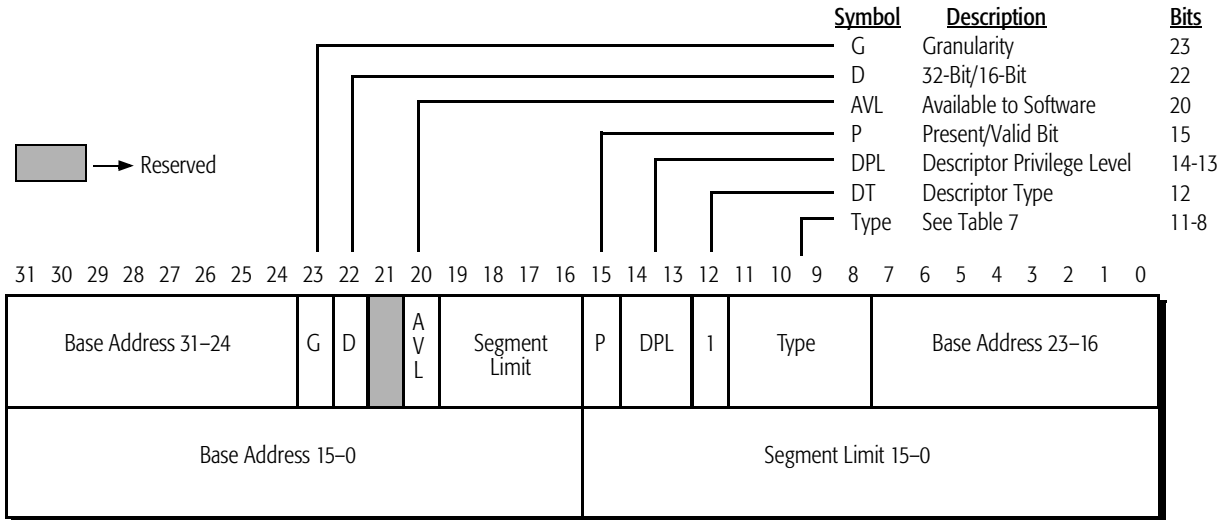

Figure 40. Application Segment Descriptor

Table 7. Application Segment Types

Type	Data/Code	Description
0	Data	Read-Only
1		Read-Only—Accessed
2		Read/Write
3		Read/Write—Accessed
4		Read-Only—Expand-down
5		Read-Only—Expand-down, Accessed
6		Read/Write—Expand-down
7		Read/Write—Expand-down, Accessed
8	Code	Execute-Only
9		Execute-Only—Accessed
A		Execute/Read
B		Execute/Read—Accessed
C		Execute-Only—Conforming
D		Execute-Only—Conforming, Accessed
E		Execute/Read-Only—Conforming
F		Execute/Read-Only—Conforming, Accessed

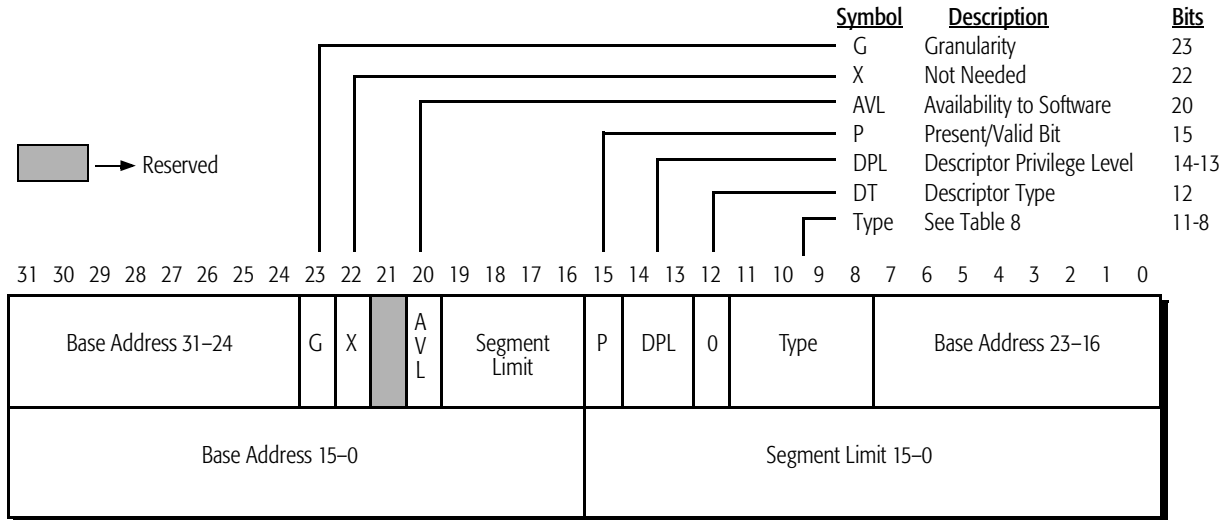

Figure 41. System Segment Descriptor

Table 8. System Segment and Gate Types

Type	Description
0	Reserved
1	Available 16-bit TSS
2	LDT
3	Busy 16-bit TSS
4	16-bit Call Gate
5	Task Gate
6	16-bit Interrupt Gate
7	16-bit Trap Gate
8	Reserved
9	Available 32-bit TSS
A	Reserved
B	Busy 32-bit TSS
C	32-bit Call Gate
D	Reserved
E	32-bit Interrupt Gate
F	32-bit Trap Gate

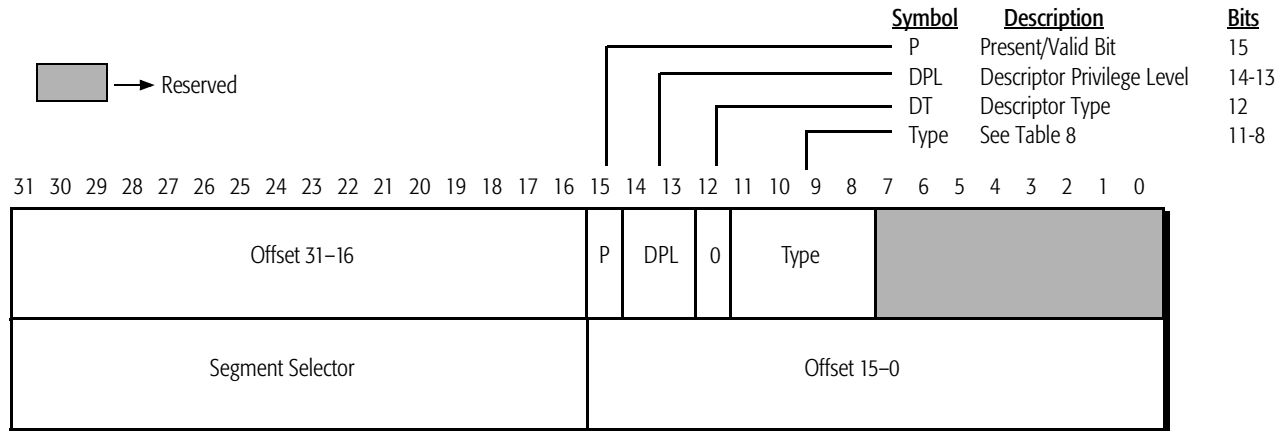

Figure 42. Gate Descriptor

Exceptions and Interrupts

Table 9 summarizes the exceptions and interrupts.

Table 9. Summary of Exceptions and Interrupts

Interrupt Number	Interrupt Type	Cause
0	Divide by Zero Error	DIV, IDIV
1	Debug	Debug trap or fault
2	Non-Maskable Interrupt	NMI signal sampled asserted
3	Breakpoint	Int 3
4	Overflow	INTO
5	Bounds Check	BOUND
6	Invalid Opcode	Invalid instruction
7	Device Not Available	ESC and WAIT
8	Double Fault	Fault occurs while handling a fault
9	Reserved - Interrupt 13	—
10	Invalid TSS	Task switch to an invalid segment
11	Segment Not Present	Instruction loads a segment and present bit is 0 (invalid segment)
12	Stack Segment	Stack operation causes limit violation or present bit is 0
13	General Protection	Segment related or miscellaneous invalid actions
14	Page Fault	Page protection violation or a reference to missing page
16	Floating-Point Error	Arithmetic error generated by floating-point instruction
17	Alignment Check	Data reference to an unaligned operand. (The AC flag and the AM bit of CR0 are set to 1.)
0-255	Software Interrupt	INT n

3.2 Instructions Supported by the AMD-K6[®] Processor

This section documents all of the x86 instructions supported by the AMD-K6 processor. The following tables show the instruction mnemonic, opcode, modR/M byte, decode type, and RISC86 operation(s) for each instruction. Tables 10 through 12 define the integer, floating-point, and MMX instructions, respectively.

The first column in these tables indicates the instruction mnemonic and operand types with the following notations:

- *reg8*—byte integer register defined by instruction byte(s) or bits 5, 4, and 3 of the modR/M byte
- *mreg8*—byte integer register defined by bits 2, 1, and 0 of the modR/M byte
- *reg16/32*—word and doubleword integer register defined by instruction byte(s) or bits 5, 4, and 3 of the modR/M byte
- *mreg16/32*—word and doubleword integer register defined by bits 2, 1, and 0 of the modR/M byte
- *mem8*—byte integer value in memory
- *mem16/32*—word or doubleword integer value in memory
- *mem32/48*—doubleword or 48-bit integer value in memory
- *mem48*—48-bit integer value in memory
- *mem64*—64-bit value in memory
- *imm8*—8-bit immediate value
- *imm16/32*—16-bit or 32-bit immediate value
- *disp8*—8-bit displacement value
- *disp16/32*—16-bit or 32-bit displacement value
- *disp32/48*—doubleword or 48-bit displacement value
- *eXX*—register width depending on the operand size
- *mem32real*—32-bit floating-point value in memory
- *mem64real*—64-bit floating-point value in memory
- *mem80real*—80-bit floating-point value in memory
- *mmreg*—MMX register
- *mmreg1*—MMX register defined by bits 5, 4, and 3 of the modR/M byte
- *mmreg2*—MMX register defined by bits 2, 1, and 0 of the modR/M byte

The second and third columns list all applicable opcode bytes.

The fourth column lists the modR/M byte when used by the instruction. The modR/M byte defines the instruction as a register or memory form. If modR/M bits 7 and 6 are documented as mm (memory form), mm can only be 10b, 01b or 00b.

The fifth column lists the type of instruction decode—short, long, and vector. The AMD-K6 decode logic can process two short, one long, or one vector decode per clock.

The sixth column lists the type of RISC86 operation(s) required for the instruction. The operation types and corresponding execution units are as follows:

- *load, fload, mload*—load unit
- *store, fstore, mstore*—store unit
- *alu*—either of the integer execution units
- *alux*—integer X execution unit only
- *branch*—branch condition unit
- *float*—floating-point execution unit
- *meu*—multimedia execution unit for MMX software
- *limm*—load immediate, instruction control unit

Table 10. Integer Instructions

Instruction Mnemonic	First Byte	Second Byte	ModR/M Byte	Decode Type	RISC86 [®] Opcodes
AAA	37h			vector	
AAD	D5h	0Ah		vector	
AAM	D4h	0Ah		vector	
AAS	3Fh			vector	
ADC mreg8, reg8	10h		11-xxx-xxx	short	alux
ADC mem8, reg8	10h		mm-xxx-xxx	long	load, alux, store
ADC mreg16/32, reg16/32	11h		11-xxx-xxx	short	alu
ADC mem16/32, reg16/32	11h		mm-xxx-xxx	long	load, alu, store
ADC reg8, mreg8	12h		11-xxx-xxx	short	alux
ADC reg8, mem8	12h		mm-xxx-xxx	short	load, alux
ADC reg16/32, mreg16/32	13h		11-xxx-xxx	short	alu
ADC reg16/32, mem16/32	13h		mm-xxx-xxx	short	load, alu
ADC AL, imm8	14h		xx-xxx-xxx	short	alux

Table 10. Integer Instructions (continued)

Instruction Mnemonic	First Byte	Second Byte	ModR/M Byte	Decode Type	RISC86 [®] Opcodes
ADC EAX, imm16/32	15h		xx-xxx-xxx	short	alu
ADC mreg8, imm8	80h		11-010-xxx	short	alux
ADC mem8, imm8	80h		mm-010-xxx	long	load, alux, store
ADC mreg16/32, imm16/32	81h		11-010-xxx	short	alu
ADC mem16/32, imm16/32	81h		mm-010-xxx	long	load, alu, store
ADC mreg16/32, imm8 (signed ext.)	83h		11-010-xxx	short	alux
ADC mem16/32, imm8 (signed ext.)	83h		mm-010-xxx	long	load, alux, store
ADD mreg8, reg8	00h		11-xxx-xxx	short	alux
ADD mem8, reg8	00h		mm-xxx-xxx	long	load, alux, store
ADD mreg16/32, reg16/32	01h		11-xxx-xxx	short	alu
ADD mem16/32, reg16/32	01h		mm-xxx-xxx	long	load, alu, store
ADD reg8, mreg8	02h		11-xxx-xxx	short	alux
ADD reg8, mem8	02h		mm-xxx-xxx	short	load, alux
ADD reg16/32, mreg16/32	03h		11-xxx-xxx	short	alu
ADD reg16/32, mem16/32	03h		mm-xxx-xxx	short	load, alu
ADD AL, imm8	04h		xx-xxx-xxx	short	alux
ADD EAX, imm16/32	05h		xx-xxx-xxx	short	alu
ADD mreg8, imm8	80h		11-000-xxx	short	alux
ADD mem8, imm8	80h		mm-000-xxx	long	load, alux, store
ADD mreg16/32, imm16/32	81h		11-000-xxx	short	alu
ADD mem16/32, imm16/32	81h		mm-000-xxx	long	load, alu, store
ADD mreg16/32, imm8 (signed ext.)	83h		11-000-xxx	short	alux
ADD mem16/32, imm8 (signed ext.)	83h		mm-000-xxx	long	load, alux, store
AND mreg8, reg8	20h		11-xxx-xxx	short	alux
AND mem8, reg8	20h		mm-xxx-xxx	long	load, alux, store
AND mreg16/32, reg16/32	21h		11-xxx-xxx	short	alu
AND mem16/32, reg16/32	21h		mm-xxx-xxx	long	load, alu, store
AND reg8, mreg8	22h		11-xxx-xxx	short	alux
AND reg8, mem8	22h		mm-xxx-xxx	short	load, alux
AND reg16/32, mreg16/32	23h		11-xxx-xxx	short	alu
AND reg16/32, mem16/32	23h		mm-xxx-xxx	short	load, alu
AND AL, imm8	24h		xx-xxx-xxx	short	alux
AND EAX, imm16/32	25h		xx-xxx-xxx	short	alu

Table 10. Integer Instructions (continued)

Instruction Mnemonic	First Byte	Second Byte	ModR/M Byte	Decode Type	RISC86 [®] Opcodes
AND mreg8, imm8	80h		11-100-xxx	short	alux
AND mem8, imm8	80h		mm-100-xxx	long	load, alux, store
AND mreg16/32, imm16/32	81h		11-100-xxx	short	alu
AND mem16/32, imm16/32	81h		mm-100-xxx	long	load, alu, store
AND mreg16/32, imm8 (signed ext.)	83h		11-100-xxx	short	alux
AND mem16/32, imm8 (signed ext.)	83h		mm-100-xxx	long	load, alux, store
ARPL mreg16, reg16	63h		11-xxx-xxx	vector	
ARPL mem16, reg16	63h		mm-xxx-xxx	vector	
BOUND	62h		xx-xxx-xxx	vector	
BSF reg16/32, mreg16/32	0Fh	BCh	11-xxx-xxx	vector	
BSF reg16/32, mem16/32	0Fh	BCh	mm-xxx-xxx	vector	
BSR reg16/32, mreg16/32	0Fh	BDh	11-xxx-xxx	vector	
BSR reg16/32, mem16/32	0Fh	BDh	mm-xxx-xxx	vector	
BSWAP EAX	0Fh	C8h		long	alu
BSWAP ECX	0Fh	C9h		long	alu
BSWAP EDX	0Fh	CAh		long	alu
BSWAP EBX	0Fh	CBh		long	alu
BSWAP ESP	0Fh	CCh		long	alu
BSWAP EBP	0Fh	CDh		long	alu
BSWAP ESI	0Fh	CEh		long	alu
BSWAP EDI	0Fh	CFh		long	alu
BT mreg16/32, reg16/32	0Fh	A3h	11-xxx-xxx	vector	
BT mem16/32, reg16/32	0Fh	A3h	mm-xxx-xxx	vector	
BT mreg16/32, imm8	0Fh	BAh	11-100-xxx	vector	
BT mem16/32, imm8	0Fh	BAh	mm-100-xxx	vector	
BTC mreg16/32, reg16/32	0Fh	BBh	11-xxx-xxx	vector	
BTC mem16/32, reg16/32	0Fh	BBh	mm-xxx-xxx	vector	
BTC mreg16/32, imm8	0Fh	BAh	11-111-xxx	vector	
BTC mem16/32, imm8	0Fh	BAh	mm-111-xxx	vector	
BTR mreg16/32, reg16/32	0Fh	B3h	11-xxx-xxx	vector	
BTR mem16/32, reg16/32	0Fh	B3h	mm-xxx-xxx	vector	
BTR mreg16/32, imm8	0Fh	BAh	11-110-xxx	vector	
BTR mem16/32, imm8	0Fh	BAh	mm-110-xxx	vector	

Table 10. Integer Instructions (continued)

Instruction Mnemonic	First Byte	Second Byte	ModR/M Byte	Decode Type	RISC86 [®] Opcodes
BTS mreg16/32, reg16/32	0Fh	ABh	11-xxx-xxx	vector	
BTS mem16/32, reg16/32	0Fh	ABh	mm-xxx-xxx	vector	
BTS mreg16/32, imm8	0Fh	BAh	11-101-xxx	vector	
BTS mem16/32, imm8	0Fh	BAh	mm-101-xxx	vector	
CALL full pointer	9Ah			vector	
CALL near imm16/32	E8h			short	store
CALL mem16:16/32	FFh		11-011-xxx	vector	
CALL near mreg32 (indirect)	FFh		11-010-xxx	vector	
CALL near mem32 (indirect)	FFh		mm-010-xxx	vector	
CBW/CWDE EAX	98h			vector	
CLC	F8h			vector	
CLD	FCh			vector	
CLI	FAh			vector	
CLTS	0Fh	06h		vector	
CMC	F5h			vector	
CMP mreg8, reg8	38h		11-xxx-xxx	short	alux
CMP mem8, reg8	38h		mm-xxx-xxx	short	load, alux
CMP mreg16/32, reg16/32	39h		11-xxx-xxx	short	alu
CMP mem16/32, reg16/32	39h		mm-xxx-xxx	short	load, alu
CMP reg8, mreg8	3Ah		11-xxx-xxx	short	alux
CMP reg8, mem8	3Ah		mm-xxx-xxx	short	load, alux
CMP reg16/32, mreg16/32	3Bh		11-xxx-xxx	short	alu
CMP reg16/32, mem16/32	3Bh		mm-xxx-xxx	short	load, alu
CMP AL, imm8	3Ch		xx-xxx-xxx	short	alux
CMP EAX, imm16/32	3Dh		xx-xxx-xxx	short	alu
CMP mreg8, imm8	80h		11-111-xxx	short	alux
CMP mem8, imm8	80h		mm-111-xxx	short	load, alux
CMP mreg16/32, imm16/32	81h		11-111-xxx	short	alu
CMP mem16/32, imm16/32	81h		mm-111-xxx	short	load, alu
CMP mreg16/32, imm8 (signed ext.)	83h		11-111-xxx	long	load, alu
CMP mem16/32, imm8 (signed ext.)	83h		mm-111-xxx	long	load, alu
CMP SB mem8, mem8	A6h			vector	
CMP SW mem16, mem32	A7h			vector	

Table 10. Integer Instructions (continued)

Instruction Mnemonic	First Byte	Second Byte	ModR/M Byte	Decode Type	RISC86 [®] Opcodes
CMPSPD mem32, mem32	A7h			vector	
CMPXCHG mreg8, reg8	0Fh	B0h	11-xxx-xxx	vector	
CMPXCHG mem8, reg8	0Fh	B0h	mm-xxx-xxx	vector	
CMPXCHG mreg16/32, reg16/32	0Fh	B1h	11-xxx-xxx	vector	
CMPXCHG mem16/32, reg16/32	0Fh	B1h	mm-xxx-xxx	vector	
CMPXCH8B EDX:EAX	0Fh	C7h	11-xxx-xxx	vector	
CMPXCH8B mem64	0Fh	C7h	mm-xxx-xxx	vector	
CPUID	0Fh	A2h		vector	
CWD/CDQ EDX, EAX	99h			vector	
DAA	27h			vector	
DAS	2Fh			vector	
DEC EAX	48h			short	alu
DEC ECX	49h			short	alu
DEC EDX	4Ah			short	alu
DEC EBX	4Bh			short	alu
DEC ESP	4Ch			short	alu
DEC EBP	4Dh			short	alu
DEC ESI	4Eh			short	alu
DEC EDI	4Fh			short	alu
DEC mreg8	FEh		11-001-xxx	vector	
DEC mem8	FEh		mm-001-xxx	long	load, alu, store
DEC mreg16/32	FFh		11-001-xxx	vector	
DEC mem16/32	FFh		mm-001-xxx	long	load, alu, store
DIV AL, mreg8	F6h		11-110-xxx	vector	
DIV AL, mem8	F6h		mm-110-xxx	vector	
DIV EAX, mreg16/32	F7h		11-110-xxx	vector	
DIV EAX, mem16/32	F7h		mm-110-xxx	vector	
IDIV mreg8	F6h		11-111-xxx	vector	
IDIV mem8	F6h		mm-111-xxx	vector	
IDIV EAX, mreg16/32	F7h		11-111-xxx	vector	
IDIV EAX, mem16/32	F7h		mm-111-xxx	vector	
IMUL reg16/32, imm16/32	69h		11-xxx-xxx	vector	
IMUL reg16/32, mreg16/32, imm16/32	69h		11-xxx-xxx	vector	

Table 10. Integer Instructions (continued)

Instruction Mnemonic	First Byte	Second Byte	ModR/M Byte	Decode Type	RISC86 [®] Opcodes
IMUL reg16/32, mem16/32, imm16/32	69h		mm-xxx-xxx	vector	
IMUL reg16/32, imm8 (sign extended)	6Bh		11-xxx-xxx	vector	
IMUL reg16/32, mreg16/32, imm8 (signed)	6Bh		11-xxx-xxx	vector	
IMUL reg16/32, mem16/32, imm8 (signed)	6Bh		mm-xxx-xxx	vector	
IMUL AX, AL, mreg8	F6h		11-101-xxx	vector	
IMUL AX, AL, mem8	F6h		mm-101-xxx	vector	
IMUL EDX:EAX, EAX, mreg16/32	F7h		11-101-xxx	vector	
IMUL EDX:EAX, EAX, mem16/32	F7h		mm-101-xxx	vector	
IMUL reg16/32, mreg16/32	0Fh	AFh	11-xxx-xxx	vector	
IMUL reg16/32, mem16/32	0Fh	AFh	mm-xxx-xxx	vector	
INC EAX	40h			short	alu
INC ECX	41h			short	alu
INC EDX	42h			short	alu
INC EBX	43h			short	alu
INC ESP	44h			short	alu
INC EBP	45h			short	alu
INC ESI	46h			short	alu
INC EDI	47h			short	alu
INC mreg8	FEh		11-000-xxx	vector	
INC mem8	FEh		mm-000-xxx	long	load, alux, store
INC mreg16/32	FFh		11-000-xxx	vector	
INC mem16/32	FFh		mm-000-xxx	long	load, alu, store
INVD	0Fh	08h		vector	
INVLPG	0Fh	01h	mm-111-xxx	vector	
JO short disp8	70h			short	branch
JB/JNAE short disp8	71h			short	branch
JNO short disp8	71h			short	branch
JNB/JAE short disp8	73h			short	branch
JZ/JE short disp8	74h			short	branch
JNZ/JNE short disp8	75h			short	branch
JBE/JNA short disp8	76h			short	branch

Table 10. Integer Instructions (continued)

Instruction Mnemonic	First Byte	Second Byte	ModR/M Byte	Decode Type	RISC86 [®] Opcodes
JNBE/JA short disp8	77h			short	branch
JS short disp8	78h			short	branch
JNS short disp8	79h			short	branch
JP/JPE short disp8	7Ah			short	branch
JNP/JPO short disp8	7Bh			short	branch
JL/JNGE short disp8	7Ch			short	branch
JNL/JGE short disp8	7Dh			short	branch
JLE/JNG short disp8	7Eh			short	branch
JNLE/JG short disp8	7Fh			short	branch
JCXZ/JEC short disp8	E3h			vector	
JO near disp16/32	0Fh	80h		short	branch
JNO near disp16/32	0Fh	81h		short	branch
JB/JNAE near disp16/32	0Fh	82h		short	branch
JNB/JAE near disp16/32	0Fh	83h		short	branch
JZ/JE near disp16/32	0Fh	84h		short	branch
JNZ/JNE near disp16/32	0Fh	85h		short	branch
JBE/JNA near disp16/32	0Fh	86h		short	branch
JNBE/JA near disp16/32	0Fh	87h		short	branch
JS near disp16/32	0Fh	88h		short	branch
JNS near disp16/32	0Fh	89h		short	branch
JP/JPE near disp16/32	0Fh	8Ah		short	branch
JNP/JPO near disp16/32	0Fh	8Bh		short	branch
JL/JNGE near disp16/32	0Fh	8Ch		short	branch
JNL/JGE near disp16/32	0Fh	8Dh		short	branch
JLE/JNG near disp16/32	0Fh	8Eh		short	branch
JNLE/JG near disp16/32	0Fh	8Fh		short	branch
JMP near disp16/32 (direct)	E9h			short	branch
JMP far disp32/48 (direct)	EAh			vector	
JMP disp8 (short)	EBh			short	branch
JMP far mreg32 (indirect)	EFh		11-101-xxx	vector	
JMP far mem32 (indirect)	EFh		mm-101-xxx	vector	
JMP near mreg16/32 (indirect)	FFh		11-100-xxx	vector	
JMP near mem16/32 (indirect)	FFh		mm-100-xxx	vector	

Table 10. Integer Instructions (continued)

Instruction Mnemonic	First Byte	Second Byte	ModR/M Byte	Decode Type	RISC86 [®] Opcodes
LAHF	9Fh			vector	
LAR reg16/32, mreg16/32	0Fh	02h	11-xxx-xxx	vector	
LAR reg16/32, mem16/32	0Fh	02h	mm-xxx-xxx	vector	
LDS reg16/32, mem32/48	C5h		mm-xxx-xxx	vector	
LEA reg16/32, mem16/32	8Dh		mm-xxx-xxx	short	load, alu
LEAVE	C9h			long	load, alu, alu
LES reg16/32, mem32/48	C4h		mm-xxx-xxx	vector	
LFS reg16/32, mem32/48	0Fh	B4h		vector	
LGDT mem48	0Fh	01h	mm-010-xxx	vector	
LGS reg16/32, mem32/48	0Fh	B5h		vector	
LIDT mem48	0Fh	01h	mm-011-xxx	vector	
LLDT mreg16	0Fh	00h	11-010-xxx	vector	
LLDT mem16	0Fh	00h	mm-010-xxx	vector	
LMSW mreg16	0Fh	01h	11-100-xxx	vector	
LMSW mem16	0Fh	01h	mm-100-xxx	vector	
LODSB AL, mem8	ACh			long	load, alux
LODSW AX, mem16	ADh			long	load, alu
LODSD EAX, mem32	ADh			long	load, alu
LOOP disp8	E2h			short	alu, branch
LOOPE/LOOPZ disp8	E1h			vector	
LOOPNE/LOOPNZ disp8	E0h			vector	
LSL reg16/32, mreg16/32	0Fh	03h	11-xxx-xxx	vector	
LSL reg16/32, mem16/32	0Fh	03h	mm-xxx-xxx	vector	
LSS reg16/32, mem32/48	0Fh	B2h	mm-xxx-xxx	vector	
LTR mreg16	0Fh	00h	11-011-xxx	vector	
LTR mem16	0Fh	00h	mm-011-xxx	vector	
MOV mreg8, reg8	88h		11-xxx-xxx	short	alux
MOV mem8, reg8	88h		mm-xxx-xxx	short	store
MOV mreg16/32, reg16/32	89h		11-xxx-xxx	short	alu
MOV mem16/32, reg16/32	89h		mm-xxx-xxx	short	store
MOV reg8, mreg8	8Ah		11-xxx-xxx	short	alux
MOV reg8, mem8	8Ah		mm-xxx-xxx	short	load
MOV reg16/32, mreg16/32	8Bh		11-xxx-xxx	short	alu

Table 10. Integer Instructions (continued)

Instruction Mnemonic	First Byte	Second Byte	ModR/M Byte	Decode Type	RISC86 [®] Opcodes
MOV reg16/32, mem16/32	8Bh		mm-xxx-xxx	short	load
MOV mreg16, segment reg	8Ch		11-xxx-xxx	long	load
MOV mem16, segment reg	8Ch		mm-xxx-xxx	vector	
MOV segment reg, mreg16	8Eh		11-xxx-xxx	vector	
MOV segment reg, mem16	8Eh		mm-xxx-xxx	vector	
MOV AL, mem8	A0h			short	load
MOV EAX, mem16/32	A1h			short	load
MOV mem8, AL	A2h			short	store
MOV mem16/32, EAX	A3h			short	store
MOV AL, imm8	B0h			short	limm
MOV CL, imm8	B1h			short	limm
MOV DL, imm8	B2h			short	limm
MOV BL, imm8	B3h			short	limm
MOV AH, imm8	B4h			short	limm
MOV CH, imm8	B5h			short	limm
MOV DH, imm8	B6h			short	limm
MOV BH, imm8	B7h			short	limm
MOV EAX, imm16/32	B8h			short	limm
MOV ECX, imm16/32	B9h			short	limm
MOV EDX, imm16/32	BAh			short	limm
MOV EBX, imm16/32	BBh			short	limm
MOV ESP, imm16/32	BCh			short	limm
MOV EBP, imm16/32	BDh			short	limm
MOV ESI, imm16/32	BEh			short	limm
MOV EDI, imm16/32	BFh			short	limm
MOV mreg8, imm8	C6h		11-000-xxx	short	limm
MOV mem8, imm8	C6h		mm-000-xxx	long	store
MOV reg16/32, imm16/32	C7h		11-000-xxx	short	limm
MOV mem16/32, imm16/32	C7h		mm-000-xxx	long	store
MOVSB mem8, mem8	A4h			long	load, store, alux, alux
MOVSD mem16, mem16	A5h			long	load, store, alu, alu
MOVSW mem32, mem32	A5h			long	load, store, alu, alu
MOVSBX reg16/32, mreg8	0Fh	BEh	11-xxx-xxx	short	alu

Table 10. Integer Instructions (continued)

Instruction Mnemonic	First Byte	Second Byte	ModR/M Byte	Decode Type	RISC86 [®] Opcodes
MOVSX reg16/32, mem8	0Fh	BEh	mm-xxx-xxx	short	load, alu
MOVSX reg32, mreg16	0Fh	BFh	11-xxx-xxx	short	alu
MOVSX reg32, mem16	0Fh	BFh	mm-xxx-xxx	short	load, alu
MOVZX reg16/32, mreg8	0Fh	B6h	11-xxx-xxx	short	alu
MOVZX reg16/32, mem8	0Fh	B6h	mm-xxx-xxx	short	load, alu
MOVZX reg32, mreg16	0Fh	B7h	11-xxx-xxx	short	alu
MOVZX reg32, mem16	0Fh	B7h	mm-xxx-xxx	short	load, alu
MUL AL, mreg8	F6h		11-100-xxx	vector	
MUL AL, mem8	F6h		mm-100-xxx	vector	
MUL EAX, mreg16/32	F7h		11-100-xxx	vector	
MUL EAX, mem16/32	F7h		mm-100-xxx	vector	
NEG mreg8	F6h		11-011-xxx	short	alux
NEG mem8	F6h		mm-011-xxx	vector	
NEG mreg16/32	F7h		11-011-xxx	short	alu
NEG mem16/32	F7h		mm-011-xxx	vector	
NOP (XCHG AX, AX)	90h			short	limm
NOT mreg8	F6h		11-010-xxx	short	alux
NOT mem8	F6h		mm-010-xxx	vector	
NOT mreg16/32	F7h		11-010-xxx	short	alu
NOT mem16/32	F7h		mm-010-xxx	vector	
OR mreg8, reg8	08h		11-xxx-xxx	short	alux
OR mem8, reg8	08h		mm-xxx-xxx	long	load, alux, store
OR mreg16/32, reg16/32	09h		11-xxx-xxx	short	alu
OR mem16/32, reg16/32	09h		mm-xxx-xxx	long	load, alu, store
OR reg8, mreg8	0Ah		11-xxx-xxx	short	alux
OR reg8, mem8	0Ah		mm-xxx-xxx	short	load, alux
OR reg16/32, mreg16/32	0Bh		11-xxx-xxx	short	alu
OR reg16/32, mem16/32	0Bh		mm-xxx-xxx	short	load, alu
OR AL, imm8	0Ch		xx-xxx-xxx	short	alux
OR EAX, imm16/32	0Dh		xx-xxx-xxx	short	alu
OR mreg8, imm8	80h		11-001-xxx	short	alux
OR mem8, imm8	80h		mm-001-xxx	long	load, alux, store
OR mreg16/32, imm16/32	81h		11-001-xxx	short	alu

Table 10. Integer Instructions (continued)

Instruction Mnemonic	First Byte	Second Byte	ModR/M Byte	Decode Type	RISC86 [®] Opcodes
OR mem16/32, imm16/32	81h		mm-001-xxx	long	load, alu, store
OR mreg16/32, imm8 (signed ext.)	83h		11-001-xxx	short	alux
OR mem16/32, imm8 (signed ext.)	83h		mm-001-xxx	long	load, alux, store
POP ES	07h			vector	
POP SS	17h			vector	
POP DS	1Fh			vector	
POP FS	0Fh	A1h		vector	
POP GS	0Fh	A9h		vector	
POP EAX	58h			short	load, alu
POP ECX	59h			short	load, alu
POP EDX	5Ah			short	load, alu
POP EBX	5Bh			short	load, alu
POP ESP	5Ch			short	load, alu
POP EBP	5Dh			short	load, alu
POP ESI	5Eh			short	load, alu
POP EDI	5Fh			short	load, alu
POP mreg	8Fh		11-000-xxx	short	load, alu
POP mem	8Fh		mm-000-xxx	long	load, store, alu
POPA/POPAD	61h			vector	
POPF/POPFd	9Dh			vector	
PUSH ES	06h			long	load, store
PUSH CS	0Eh			vector	
PUSH FS	0Fh	A0h		vector	
PUSH GS	0Fh	A8h		vector	
PUSH SS	16h			vector	
PUSH DS	1Eh			long	load, store
PUSH EAX	50h			short	store
PUSH ECX	51h			short	store
PUSH EDX	52h			short	store
PUSH EBX	53h			short	store
PUSH ESP	54h			short	store
PUSH EBP	55h			short	store
PUSH ESI	56h			short	store

Table 10. Integer Instructions (continued)

Instruction Mnemonic	First Byte	Second Byte	ModR/M Byte	Decode Type	RISC86 [®] Opcodes
PUSH EDI	57h			short	store
PUSH imm8	6Ah			long	store
PUSH imm16/32	68h			long	store
PUSH mreg16/32	FFh		11-110-xxx	vector	
PUSH mem16/32	FFh		mm-110-xxx	long	load, store
PUSHA/PUSHAD	60h			vector	
PUSHF/PUSHFD	9Ch			vector	
RCL mreg8, imm8	C0h		11-010-xxx	vector	
RCL mem8, imm8	C0h		mm-010-xxx	vector	
RCL mreg16/32, imm8	C1h		11-010-xxx	vector	
RCL mem16/32, imm8	C1h		mm-010-xxx	vector	
RCL mreg8, 1	D0h		11-010-xxx	vector	
RCL mem8, 1	D0h		mm-010-xxx	vector	
RCL mreg16/32, 1	D1h		11-010-xxx	vector	
RCL mem16/32, 1	D1h		mm-010-xxx	vector	
RCL mreg8, CL	D2h		11-010-xxx	vector	
RCL mem8, CL	D2h		mm-010-xxx	vector	
RCL mreg16/32, CL	D3h		11-010-xxx	vector	
RCL mem16/32, CL	D3h		mm-010-xxx	vector	
RCR mreg8, imm8	C0h		11-011-xxx	vector	
RCR mem8, imm8	C0h		mm-011-xxx	vector	
RCR mreg16/32, imm8	C1h		11-011-xxx	vector	
RCR mem16/32, imm8	C1h		mm-011-xxx	vector	
RCR mreg8, 1	D0h		11-011-xxx	vector	
RCR mem8, 1	D0h		mm-011-xxx	vector	
RCR mreg16/32, 1	D1h		11-011-xxx	vector	
RCR mem16/32, 1	D1h		mm-011-xxx	vector	
RCR mreg8, CL	D2h		11-011-xxx	vector	
RCR mem8, CL	D2h		mm-011-xxx	vector	
RCR mreg16/32, CL	D3h		11-011-xxx	vector	
RCR mem16/32, CL	D3h		mm-011-xxx	vector	
RET near imm16	C2h			vector	
RET near	C3h			vector	

Table 10. Integer Instructions (continued)

Instruction Mnemonic	First Byte	Second Byte	ModR/M Byte	Decode Type	RISC86 [®] Opcodes
RET far imm16	CAh			vector	
RET far	CBh			vector	
ROL mreg8, imm8	C0h		11-000-xxx	vector	
ROL mem8, imm8	C0h		mm-000-xxx	vector	
ROL mreg16/32, imm8	C1h		11-000-xxx	vector	
ROL mem16/32, imm8	C1h		mm-000-xxx	vector	
ROL mreg8, 1	D0h		11-000-xxx	vector	
ROL mem8, 1	D0h		mm-000-xxx	vector	
ROL mreg16/32, 1	D1h		11-000-xxx	vector	
ROL mem16/32, 1	D1h		mm-000-xxx	vector	
ROL mreg8, CL	D2h		11-000-xxx	vector	
ROL mem8, CL	D2h		mm-000-xxx	vector	
ROL mreg16/32, CL	D3h		11-000-xxx	vector	
ROL mem16/32, CL	D3h		mm-000-xxx	vector	
ROR mreg8, imm8	C0h		11-001-xxx	vector	
ROR mem8, imm8	C0h		mm-001-xxx	vector	
ROR mreg16/32, imm8	C1h		11-001-xxx	vector	
ROR mem16/32, imm8	C1h		mm-001-xxx	vector	
ROR mreg8, 1	D0h		11-001-xxx	vector	
ROR mem8, 1	D0h		mm-001-xxx	vector	
ROR mreg16/32, 1	D1h		11-001-xxx	vector	
ROR mem16/32, 1	D1h		mm-001-xxx	vector	
ROR mreg8, CL	D2h		11-001-xxx	vector	
ROR mem8, CL	D2h		mm-001-xxx	vector	
ROR mreg16/32, CL	D3h		11-001-xxx	vector	
ROR mem16/32, CL	D3h		mm-001-xxx	vector	
SAHF	9Eh			vector	
SAR mreg8, imm8	C0h		11-111-xxx	short	alux
SAR mem8, imm8	C0h		mm-111-xxx	vector	
SAR mreg16/32, imm8	C1h		11-111-xxx	short	alu
SAR mem16/32, imm8	C1h		mm-111-xxx	vector	
SAR mreg8, 1	D0h		11-111-xxx	short	alux
SAR mem8, 1	D0h		mm-111-xxx	vector	

Table 10. Integer Instructions (continued)

Instruction Mnemonic	First Byte	Second Byte	ModR/M Byte	Decode Type	RISC86® Opcodes
SAR mreg16/32, 1	D1h		11-111-xxx	short	alu
SAR mem16/32, 1	D1h		mm-111-xxx	vector	
SAR mreg8, CL	D2h		11-111-xxx	short	alux
SAR mem8, CL	D2h		mm-111-xxx	vector	
SAR mreg16/32, CL	D3h		11-111-xxx	short	alu
SAR mem16/32, CL	D3h		mm-111-xxx	vector	
SBB mreg8, reg8	18h		11-xxx-xxx	short	alux
SBB mem8, reg8	18h		mm-xxx-xxx	long	load, alux, store
SBB mreg16/32, reg16/32	19h		11-xxx-xxx	short	alu
SBB mem16/32, reg16/32	19h		mm-xxx-xxx	long	load, alu, store
SBB reg8, mreg8	1Ah		11-xxx-xxx	short	alux
SBB reg8, mem8	1Ah		mm-xxx-xxx	short	load, alux
SBB reg16/32, mreg16/32	1Bh		11-xxx-xxx	short	alu
SBB reg16/32, mem16/32	1Bh		mm-xxx-xxx	short	load, alu
SBB AL, imm8	1Ch		xx-xxx-xxx	short	alux
SBB EAX, imm16/32	1Dh		xx-xxx-xxx	short	alu
SBB mreg8, imm8	80h		11-011-xxx	short	alux
SBB mem8, imm8	80h		mm-011-xxx	long	load, alux, store
SBB mreg16/32, imm16/32	81h		11-011-xxx	short	alu
SBB mem16/32, imm16/32	81h		mm-011-xxx	long	load, alu, store
SBB mreg8, imm8 (signed ext.)	83h		11-011-xxx	short	alux
SBB mem8, imm8 (signed ext.)	83h		mm-011-xxx	long	load, alux, store
SCASB AL, mem8	A Eh			vector	
SCASW AX, mem16	A Fh			vector	
SCASD EAX, mem32	A Fh			vector	
SETO mreg8	0Fh	90h	11-xxx-xxx	vector	
SETO mem8	0Fh	90h	mm-xxx-xxx	vector	
SETNO mreg8	0Fh	91h	11-xxx-xxx	vector	
SETNO mem8	0Fh	91h	mm-xxx-xxx	vector	
SETB/SETNAE mreg8	0Fh	92h	11-xxx-xxx	vector	
SETB/SETNAE mem8	0Fh	92h	mm-xxx-xxx	vector	
SETNB/SETAE mreg8	0Fh	93h	11-xxx-xxx	vector	
SETNB/SETAE mem8	0Fh	93h	mm-xxx-xxx	vector	

Table 10. Integer Instructions (continued)

Instruction Mnemonic	First Byte	Second Byte	ModR/M Byte	Decode Type	RISC86 [®] Opcodes
SETZ/SETE mreg8	0Fh	94h	11-xxx-xxx	vector	
SETZ/SETE mem8	0Fh	94h	mm-xxx-xxx	vector	
SETNZ/SETNE mreg8	0Fh	95h	11-xxx-xxx	vector	
SETNZ/SETNE mem8	0Fh	95h	mm-xxx-xxx	vector	
SETBE/SETNA mreg8	0Fh	96h	11-xxx-xxx	vector	
SETBE/SETNA mem8	0Fh	96h	mm-xxx-xxx	vector	
SETNBE/SETA mreg8	0Fh	97h	11-xxx-xxx	vector	
SETNBE/SETA mem8	0Fh	97h	mm-xxx-xxx	vector	
SETS mreg8	0Fh	98h	11-xxx-xxx	vector	
SETS mem8	0Fh	98h	mm-xxx-xxx	vector	
SETNS mreg8	0Fh	99h	11-xxx-xxx	vector	
SETNS mem8	0Fh	99h	mm-xxx-xxx	vector	
SETP/SETPE mreg8	0Fh	9Ah	11-xxx-xxx	vector	
SETP/SETPE mem8	0Fh	9Ah	mm-xxx-xxx	vector	
SETNP/SETPO mreg8	0Fh	9Bh	11-xxx-xxx	vector	
SETNP/SETPO mem8	0Fh	9Bh	mm-xxx-xxx	vector	
SETL/SETNGE mreg8	0Fh	9Ch	11-xxx-xxx	vector	
SETL/SETNGE mem8	0Fh	9Ch	mm-xxx-xxx	vector	
SETNL/SETGE mreg8	0Fh	9Dh	11-xxx-xxx	vector	
SETNL/SETGE mem8	0Fh	9Dh	mm-xxx-xxx	vector	
SETLE/SETNG mreg8	0Fh	9Eh	11-xxx-xxx	vector	
SETLE/SETNG mem8	0Fh	9Eh	mm-xxx-xxx	vector	
SETNLE/SETG mreg8	0Fh	9Fh	11-xxx-xxx	vector	
SETNLE/SETG mem8	0Fh	9Fh	mm-xxx-xxx	vector	
SGDT mem48	0Fh	01h	mm-000-xxx	vector	
SIDT mem48	0Fh	01h	mm-001-xxx	vector	
SHL/SAL mreg8, imm8	C0h		11-100-xxx	short	alux
SHL/SAL mem8, imm8	C0h		mm-100-xxx	vector	
SHL/SAL mreg16/32, imm8	C1h		11-100-xxx	short	alu
SHL/SAL mem16/32, imm8	C1h		mm-100-xxx	vector	
SHL/SAL mreg8, 1	D0h		11-100-xxx	short	alux
SHL/SAL mem8, 1	D0h		mm-100-xxx	vector	
SHL/SAL mreg16/32, 1	D1h		11-100-xxx	short	alu

Table 10. Integer Instructions (continued)

Instruction Mnemonic	First Byte	Second Byte	ModR/M Byte	Decode Type	RISC86® Opcodes
SHL/SAL mem16/32, 1	D1h		mm-100-xxx	vector	
SHL/SAL mreg8, CL	D2h		11-100-xxx	short	alux
SHL/SAL mem8, CL	D2h		mm-100-xxx	vector	
SHL/SAL mreg16/32, CL	D3h		11-100-xxx	short	alu
SHL/SAL mem16/32, CL	D3h		mm-100-xxx	vector	
SHR mreg8, imm8	C0h		11-101-xxx	short	alux
SHR mem8, imm8	C0h		mm-101-xxx	vector	
SHR mreg16/32, imm8	C1h		11-101-xxx	short	alu
SHR mem16/32, imm8	C1h		mm-101-xxx	vector	
SHR mreg8, 1	D0h		11-101-xxx	short	alux
SHR mem8, 1	D0h		mm-101-xxx	vector	
SHR mreg16/32, 1	D1h		11-101-xxx	short	alu
SHR mem16/32, 1	D1h		mm-101-xxx	vector	
SHR mreg8, CL	D2h		11-101-xxx	short	alux
SHR mem8, CL	D2h		mm-101-xxx	vector	
SHR mreg16/32, CL	D3h		11-101-xxx	short	alu
SHR mem16/32, CL	D3h		mm-101-xxx	vector	
SHLD mreg16/32, reg16/32, imm8	0Fh	A4h	11-xxx-xxx	vector	
SHLD mem16/32, reg16/32, imm8	0Fh	A4h	mm-xxx-xxx	vector	
SHLD mreg16/32, reg16/32, CL	0Fh	A5h	11-xxx-xxx	vector	
SHLD mem16/32, reg16/32, CL	0Fh	A5h	mm-xxx-xxx	vector	
SHRD mreg16/32, reg16/32, imm8	0Fh	ACH	11-xxx-xxx	vector	
SHRD mem16/32, reg16/32, imm8	0Fh	ACH	mm-xxx-xxx	vector	
SHRD mreg16/32, reg16/32, CL	0Fh	ADh	11-xxx-xxx	vector	
SHRD mem16/32, reg16/32, CL	0Fh	ADh	mm-xxx-xxx	vector	
SLDT mreg16	0Fh	00h	11-000-xxx	vector	
SLDT mem16	0Fh	00h	mm-000-xxx	vector	
SMSW mreg16	0Fh	01h	11-100-xxx	vector	
SMSW mem16	0Fh	01h	mm-100-xxx	vector	
STC	F9h			vector	
STD	FDh			vector	
STI	FBh			vector	
STOSB mem8, AL	AAh			long	store, alux

Table 10. Integer Instructions (continued)

Instruction Mnemonic	First Byte	Second Byte	ModR/M Byte	Decode Type	RISC86 [®] Opcodes
STOSW mem16, AX	ABh			long	store, alu
STOSD mem32, EAX	ABh			long	store, alu
STR mreg16	0Fh	00h	11-001-xxx	vector	
STR mem16	0Fh	00h	mm-001-xxx	vector	
SUB mreg8, reg8	28h		11-xxx-xxx	short	alux
SUB mem8, reg8	28h		mm-xxx-xxx	long	load, alux, store
SUB mreg16/32, reg16/32	29h		11-xxx-xxx	short	alu
SUB mem16/32, reg16/32	29h		mm-xxx-xxx	long	load, alu, store
SUB reg8, mreg8	2Ah		11-xxx-xxx	short	alux
SUB reg8, mem8	2Ah		mm-xxx-xxx	short	load, alux
SUB reg16/32, mreg16/32	2Bh		11-xxx-xxx	short	alu
SUB reg16/32, mem16/32	2Bh		mm-xxx-xxx	short	load, alu
SUB AL, imm8	2Ch		xx-xxx-xxx	short	alux
SUB EAX, imm16/32	2Dh		xx-xxx-xxx	short	alu
SUB mreg8, imm8	80h		11-101-xxx	short	alux
SUB mem8, imm8	80h		mm-101-xxx	long	load, alux, store
SUB mreg16/32, imm16/32	81h		11-101-xxx	short	alu
SUB mem16/32, imm16/32	81h		mm-101-xxx	long	load, alu, store
SUB mreg16/32, imm8 (signed ext.)	83h		11-101-xxx	short	alux
SUB mem16/32, imm8 (signed ext.)	83h		mm-101-xxx	long	load, alux, store
TEST mreg8, reg8	84h		11-xxx-xxx	short	alux
TEST mem8, reg8	84h		mm-xxx-xxx	vector	
TEST mreg16/32, reg16/32	85h		11-xxx-xxx	short	alu
TEST mem16/32, reg16/32	85h		mm-xxx-xxx	vector	
TEST AL, imm8	A8h			long	alux
TEST EAX, Imm16/32	A9h			long	alu
TEST mreg8, imm8	F6h		11-000-xxx	long	alux
TEST mem8, imm8	F6h		mm-000-xxx	long	load, alux
TEST mreg8, imm16/32	F7h		11-000-xxx	long	alu
TEST mem8, imm16/32	F7h		mm-000-xxx	long	load, alu
VERR mreg16	0Fh	00h	11-100-xxx	vector	
VERR mem16	0Fh	00h	mm-100-xxx	vector	
VERW mreg16	0Fh	00h	11-101-xxx	vector	

Table 10. Integer Instructions (continued)

Instruction Mnemonic	First Byte	Second Byte	ModR/M Byte	Decode Type	RISC86 [®] Opcodes
VERW mem16	0Fh	00h	mm-101-xxx	vector	
WAIT	9Bh			vector	
WBINVD	0Fh	09h		vector	
XADD mreg8, reg8	0Fh	C0h	11-100-xxx	vector	
XADD mem8, reg8	0Fh	C0h	mm-100-xxx	vector	
XADD mreg16/32, reg16/32	0Fh	C1h	11-101-xxx	vector	
XADD mem16/32, reg16/32	0Fh	C1h	mm-101-xxx	vector	
XCHG reg8, mreg8	86h		11-xxx-xxx	vector	
XCHG reg8, mem8	86h		mm-xxx-xxx	vector	
XCHG reg16/32, mreg16/32	87h		11-xxx-xxx	vector	
XCHG reg16/32, mem16/32	87h		mm-xxx-xxx	vector	
XCHG EAX, EAX	90h			short	limm
XCHG EAX, ECX	91h			long	alu, alu, alu
XCHG EAX, EDX	92h			long	alu, alu, alu
XCHG EAX, EBX	93h			long	alu, alu, alu
XCHG EAX, ESP	94h			long	alu, alu, alu
XCHG EAX, EBP	95h			long	alu, alu, alu
XCHG EAX, ESI	96h			long	alu, alu, alu
XCHG EAX, EDI	97h			long	alu, alu, alu
XLAT	D7h			vector	
XOR mreg8, reg8	30h		11-xxx-xxx	short	alux
XOR mem8, reg8	30h		mm-xxx-xxx	long	load, alux, store
XOR mreg16/32, reg16/32	31h		11-xxx-xxx	short	alu
XOR mem16/32, reg16/32	31h		mm-xxx-xxx	long	load, alu, store
XOR reg8, mreg8	32h		11-xxx-xxx	short	alux
XOR reg8, mem8	32h		mm-xxx-xxx	short	load, alux
XOR reg16/32, mreg16/32	33h		11-xxx-xxx	short	alu
XOR reg16/32, mem16/32	33h		mm-xxx-xxx	short	load, alu
XOR AL, imm8	34h		xx-xxx-xxx	short	alux
XOR EAX, imm16/32	35h		xx-xxx-xxx	short	alu
XOR mreg8, imm8	80h		11-110-xxx	short	alux
XOR mem8, imm8	80h		mm-110-xxx	long	load, alux, store
XOR mreg16/32, imm16/32	81h		11-110-xxx	short	alu

Table 10. Integer Instructions (continued)

Instruction Mnemonic	First Byte	Second Byte	ModR/M Byte	Decode Type	RISC86 [®] Opcodes
XOR mem16/32, imm16/32	81h		mm-110-xxx	long	load, alu, store
XOR mreg16/32, imm8 (signed ext.)	83h		11-110-xxx	short	alux
XOR mem16/32, imm8 (signed ext.)	83h		mm-110-xxx	long	load, alux, store

Table 11. Floating-Point Instructions

Instruction Mnemonic	First Byte	Second Byte	ModR/M Byte	Decode Type	RISC86 [®] Opcodes	Note
F2XM1	D9h	F0h		short	float	
FABS	D9h	F1h		short	float	
FADD ST(0), ST(i)	D8h		11-000-xxx	short	float	*
FADD ST(0), mem32real	D8h		mm-000-xxx	short	float, float	
FADD ST(i), ST(0)	DCh		11-000-xxx	short	float	*
FADD ST(0), mem64real	DCh		mm-000-xxx	short	float, float	
FADDP ST(i), ST(0)	DEh		11-000-xxx	short	float	*
FBLD	DFh		mm-100-xxx	vector		*
FBSTP	DFh		mm-110-xxx	vector		*
FCHS	D9h	E0h		short	float	
FCLEX	DBh	E2h		vector		
FCOM ST(0), ST(i)	D8h		11-010-xxx	short	float	*
FCOM ST(0), mem32real	D8h		mm-010-xxx	short	float, float	
FCOM ST(0), mem64real	DCh		mm-010-xxx	short	float, float	
FCOMP ST(0), ST(i)	D8h		11-011-xxx	short	float	*
FCOMP ST(0), mem32real	D8h		mm-011-xxx	short	float, float	
FCOMP ST(0), mem64real	DCh		mm-011-xxx	short	float, float	
FCOMPP	DEh		11-011-001	short	float	
FCOS ST(0)	D9h	FFh		short	float	
FDECSTP	D9h	F6h		short	float	
FDIV ST(0), ST(i) (single precision)	D8h		11-110-xxx	short	float	*
FDIV ST(0), ST(i) (double precision)	D8h		11-110-xxx	short	float	*
FDIV ST(0), ST(i) (extended precision)	D8h		11-110-xxx	short	float	*

Note:

* The last three bits of the modR/M byte select the stack entry ST(i).

Table 11. Floating-Point Instructions (continued)

Instruction Mnemonic	First Byte	Second Byte	ModR/M Byte	Decode Type	RISC86® Opcodes	Note
FDIV ST(i), ST(0) (single precision)	DCh		11-111-xxx	short	float	*
FDIV ST(i), ST(0) (double precision)	DCh		11-111-xxx	short	float	*
FDIV ST(i), ST(0) (extended precision)	DCh		11-111-xxx	short	float	*
FDIV ST(0), mem32real	D8h		mm-110-xxx	short	fload, float	
FDIV ST(0), mem64real	DCh		mm-110-xxx	short	fload, float	
FDIVP ST(0), ST(i)	DEh		11-111-xxx	short	float	*
FDIVR ST(0), ST(i)	D8h		11-110-xxx	short	float	*
FDIVR ST(l), ST(0)	DCh		11-111-xxx	short	float	*
FDIVR ST(0), mem32real	D8h		mm-111-xxx	short	fload, float	
FDIVR ST(0), mem64real	DCh		mm-111-xxx	short	fload, float	
FDIVRP ST(i), ST(0)	DEh		11-110-xxx	short	float	*
FFREE ST(l)	DDh		11-000-xxx	short	float	*
FIADD ST(0), mem32int	DAh		mm-000-xxx	short	fload, float	
FIADD ST(0), mem16int	DEh		mm-000-xxx	short	fload, float	
FICOM ST(0), mem32int	DAh		mm-010-xxx	short	fload, float	
FICOM ST(0), mem16int	DEh		mm-010-xxx	short	fload, float	
FICOMP ST(0), mem32int	DAh		mm-011-xxx	short	fload, float	
FICOMP ST(0), mem16int	DEh		mm-011-xxx	short	fload, float	
FIDIV ST(0), mem32int	DAh		mm-110-xxx	short	fload, float	
FIDIV ST(0), mem16int	DEh		mm-110-xxx	short	fload, float	
FIDIVR ST(0), mem32int	DAh		mm-111-xxx	short	fload, float	
FIDIVR ST(0), mem16int	DEh		mm-111-xxx	short	fload, float	
FILD mem16int	DFh		mm-000-xxx	short	fload, float	
FILD mem32int	DBh		mm-000-xxx	short	fload, float	
FILD mem64int	DFh		mm-101-xxx	short	fload, float	
FIMUL ST(0), mem32int	DAh		mm-001-xxx	short	fload, float	
FIMUL ST(0), mem16int	DEh		mm-001-xxx	short	fload, float	
FINCSTP	D9h	F7h		short	float	
FINIT	DBh	E3h		vector		
FIST mem16int	DFh		mm-010-xxx	short	fload, float	
FIST mem32int	DBh		mm-010-xxx	short	fload, float	

Note:

* The last three bits of the modR/M byte select the stack entry ST(i).

Table 11. Floating-Point Instructions (continued)

Instruction Mnemonic	First Byte	Second Byte	ModR/M Byte	Decode Type	RISC86 [®] Opcodes	Note
FISTP mem16int	DFh		mm-011-xxx	short	float, float	
FISTP mem32int	DBh		mm-011-xxx	short	float, float	
FISTP mem64int	DFh		mm-111-xxx	short	float, float	
FISUB ST(0), mem32int	DAh		mm-100-xxx	short	float, float	
FISUB ST(0), mem16int	DEh		mm-100-xxx	short	float, float	
FISUBR ST(0), mem32int	DAh		mm-101-xxx	short	float, float	
FISUBR ST(0), mem16int	DEh		mm-101-xxx	short	float, float	
FLD ST(i)	D9h		11-000-xxx	short	float, float	*
FLD mem32real	D9h		mm-000-xxx	short	float, float	
FLD mem64real	DDh		mm-000-xxx	short	float, float	
FLD mem80real	DBh		mm-101-xxx	vector		
FLD1	D9h	E8h		short	float, float	
FLDCW	D9h		mm-101-xxx	vector		
FLDENV	D9h		mm-100-xxx	short	float, float	
FLDL2E	D9h	EAh		short	float	
FLDL2T	D9h	E9h		short	float	
FLDLG2	D9h	ECh		short	float	
FLDLN2	D9h	EDh		short	float	
FLDPI	D9h	EBh		short	float	
FLDZ	D9h	EEh		short	float	
FMUL ST(0), ST(i)	D8h		11-001-xxx	short	float	*
FMUL ST(i), ST(0)	DCh		11-001-xxx	short	float	*
FMUL ST(0), mem32real	D8h		mm-001-xxx	short	float, float	
FMUL ST(0), mem64real	DCh		mm-001-xxx	short	float, float	
FMULP ST(0), ST(i)	DEh		11-001-xxx	short	float	
FNOP	D9h	D0h		short	float	
FPATAN	D9h	F3h		short	float	
FPREM	D9h	F8h		short	float	
FPREM1	D9h	F5h		short	float	
FPTAN	D9h	F2h		vector		
FRNDINT	D9h	FCh		short	float	

Note:

* The last three bits of the modR/M byte select the stack entry ST(i).

Table 11. Floating-Point Instructions (continued)

Instruction Mnemonic	First Byte	Second Byte	ModR/M Byte	Decode Type	RISC86 [®] Opcodes	Note
FRSTOR	DDh		mm-100-xxx	vector		
FSAVE	DDh		mm-110-xxx	vector		
FSCALE	D9h	FDh		short	float	
FSIN	D9h	FEh		short	float	
FSINCOS	D9h	FBh		vector		
FSQRT (single precision)	D9h	FAh		short	float	
FSQRT (double precision)	D9h	FAh		short	float	
FSQRT (extended precision)	D9h	FAh		short	float	
FST mem32real	D9h		mm-010-xxx	short	fstore	
FST mem64real	DDh		mm-010-xxx	short	fstore	
FST ST(i)	DDh		11-010xxx	short	fstore	
FSTCW	D9h		mm-111-xxx	vector		
FSTENV	D9h		mm-110-xxx	vector		
FSTP mem32real	D9h		mm-011-xxx	short	fstore	
FSTP mem64real	DDh		mm-011-xxx	short	fstore	
FSTP mem80real	D9h		mm-111-xxx	vector		
FSTP ST(i)	DDh		11-011-xxx	short	float	
FSTSW AX	DFh	E0h		vector		
FSTSW mem16	DDh		mm-111-xxx	vector		
FSUB ST(0), mem32real	D8h		mm-100-xxx	short	float, float	
FSUB ST(0), mem64real	DCh		mm-100-xxx	short	float, float	
FSUB ST(0), ST(i)	D8h		11-100-xxx	short	float	
FSUB ST(i), ST(0)	DCh		11-101-xxx	short	float	
FSUBP ST(0), ST(l)	DEh		11-101-xxx	short	float	
FSUBR ST(0), mem32real	D8h		mm-101-xxx	short	float, float	
FSUBR ST(0), mem64real	DCh		mm-101-xxx	short	float, float	
FSUBR ST(0), ST(l)	D8h		11-100-xxx	short	float	
FSUBR ST(i), ST(0)	DCh		11-101-xxx	short	float	
FSUBRP ST(i), ST(0)	DEh		11-100-xxx	short	float	
FTST	D9h	E4h		short	float	
FUCOM	DDh		11-100-xxx	short	float	

Note:

* The last three bits of the modR/M byte select the stack entry ST(i).

Table 11. Floating-Point Instructions (continued)

Instruction Mnemonic	First Byte	Second Byte	ModR/M Byte	Decode Type	RISC86 [®] Opcodes	Note
FUCOMP	DDh		11-101-xxx	short	float	
FUCOMPP	DAh	E9h		short	float	
FXAM	D9h	E5h		short	float	
FXCH	D9h		11-001-xxx	short	float	
EXTRACT	D9h	F4h		vector		
FYL2X	D9h	F1h		short	float	
FYL2XP1	D9h	F9h		short	float	
FWAIT	9Bh			vector		
Note:						
* The last three bits of the modR/M byte select the stack entry ST(i).						

Table 12. MMX™ Instructions

Instruction Mnemonic	Prefix Byte(s)	First Byte	ModR/M Byte	Decode Type	RISC86 [®] Opcodes	Note
EMMS	0Fh	77h		vector		
MOVD mmreg, mreg32	0Fh	6Eh	11-xxx-xxx	short	store, mload	*
MOVD mmreg, mem32	0Fh	6Eh	mm-xxx-xxx	short	mload	
MOVD mreg32, mmreg	0Fh	7Eh	11-xxx-xxx	short	mstore, load	*
MOVD mem32, mmreg	0Fh	7Eh	mm-xxx-xxx	short	mstore	
MOVQ mmreg1, mmreg2	0Fh	6Fh	11-xxx-xxx	short	meu	
MOVQ mmreg, mem64	0Fh	6Fh	mm-xxx-xxx	short	mload	
MOVQ mmreg1, mmreg2	0Fh	7Fh	11-xxx-xxx	short	meu	
MOVQ mem64, mmreg	0Fh	7Fh	mm-xxx-xxx	short	mstore	
PACKSSDW mmreg1, mmreg2	0Fh	6Bh	11-xxx-xxx	short	meu	
PACKSSDW mmreg, mem64	0Fh	6Bh	mm-xxx-xxx	short	mload, meu	
PACKSSWB mmreg1, mmreg2	0Fh	63h	11-xxx-xxx	short	meu	
PACKSSWB mmreg, mem64	0Fh	64h	mm-xxx-xxx	short	mload, meu	
PACKUSWB mmreg1, mmreg2	0Fh	67h	11-xxx-xxx	short	meu	
PACKUSWB mmreg, mem64	0Fh	67h	mm-xxx-xxx	short	mload, meu	
PADDB mmreg1, mmreg2	0Fh	FCh	11-xxx-xxx	short	meu	
PADDB mmreg, mem64	0Fh	FCh	mm-xxx-xxx	short	mload, meu	
Note:						
* Bits 2, 1, and 0 of the modR/M byte select the integer register.						

Table 12. MMX™ Instructions (continued)

Instruction Mnemonic	Prefix Byte(s)	First Byte	ModR/M Byte	Decode Type	RISC86® Opcodes	Note
PADD mmreg1, mmreg2	0Fh	FEh	11-xxx-xxx	short	meu	
PADD mmreg, mem64	0Fh	FEh	mm-xxx-xxx	short	mload, meu	
PADDSB mmreg1, mmreg2	0Fh	ECh	11-xxx-xxx	short	meu	
PADDSB mmreg, mem64	0Fh	ECh	mm-xxx-xxx	short	mload, meu	
PADDSW mmreg1, mmreg2	0Fh	EDh	11-xxx-xxx	short	meu	
PADDSW mmreg, mem64	0Fh	EDh	mm-xxx-xxx	short	mload, meu	
PADDUSB mmreg1, mmreg2	0Fh	DCh	11-xxx-xxx	short	meu	
PADDUSB mmreg, mem64	0Fh	DCh	mm-xxx-xxx	short	mload, meu	
PADDUSW mmreg1, mmreg2	0Fh	DDh	11-xxx-xxx	short	meu	
PADDUSW mmreg, mem64	0Fh	DDh	mm-xxx-xxx	short	mload, meu	
PADDW mmreg1, mmreg2	0Fh	FDh	11-xxx-xxx	short	meu	
PADDW mmreg, mem64	0Fh	FDh	mm-xxx-xxx	short	mload, meu	
PAND mmreg1, mmreg2	0Fh	DBh	11-xxx-xxx	short	meu	
PAND mmreg, mem64	0Fh	DBh	mm-xxx-xxx	short	mload, meu	
PANDN mmreg1, mmreg2	0Fh	DFh	11-xxx-xxx	short	meu	
PANDN mmreg, mem64	0Fh	DFh	mm-xxx-xxx	short	mload, meu	
PCMPEQB mmreg1, mmreg2	0Fh	74h	11-xxx-xxx	short	meu	
PCMPEQB mmreg, mem64	0Fh	74h	mm-xxx-xxx	short	mload, meu	
PCMPEQD mmreg1, mmreg2	0Fh	76h	11-xxx-xxx	short	meu	
PCMPEQD mmreg, mem64	0Fh	76h	mm-xxx-xxx	short	mload, meu	
PCMPEQW mmreg1, mmreg2	0Fh	75h	11-xxx-xxx	short	meu	
PCMPEQW mmreg, mem64	0Fh	75h	mm-xxx-xxx	short	mload, meu	
PCMPGTB mmreg1, mmreg2	0Fh	64h	11-xxx-xxx	short	meu	
PCMPGTB mmreg, mem64	0Fh	64h	mm-xxx-xxx	short	mload, meu	
PCMPGTD mmreg1, mmreg2	0Fh	66h	11-xxx-xxx	short	meu	
PCMPGTD mmreg, mem64	0Fh	66h	mm-xxx-xxx	short	mload, meu	
PCMPGTW mmreg1, mmreg2	0Fh	65h	11-xxx-xxx	short	meu	
PCMPGTW mmreg, mem64	0Fh	65h	mm-xxx-xxx	short	mload, meu	
PMADDWD mmreg1, mmreg2	0Fh	F5h	11-xxx-xxx	short	meu	
PMADDWD mmreg, mem64	0Fh	F5h	mm-xxx-xxx	short	mload, meu	
PMULHW mmreg1, mmreg2	0Fh	E5h	11-xxx-xxx	short	meu	

Note:

* Bits 2, 1, and 0 of the modR/M byte select the integer register.

Table 12. MMX™ Instructions (continued)

Instruction Mnemonic	Prefix Byte(s)	First Byte	ModR/M Byte	Decode Type	RISC86 [®] Opcodes	Note
PMULHW mmreg, mem64	0Fh	E5h	mm-xxx-xxx	short	mload, meu	
PMULLW mmreg1, mmreg2	0Fh	D5h	11-xxx-xxx	short	meu	
PMULLW mmreg, mem64	0Fh	D5h	mm-xxx-xxx	short	mload, meu	
POR mmreg1, mmreg2	0Fh	EBh	11-xxx-xxx	short	meu	
POR mmreg, mem64	0Fh	EBh	mm-xxx-xxx	short	mload, meu	
PSLLW mmreg1, mmreg2	0Fh	F1h	11-xxx-xxx	short	meu	
PSLLW mmreg, mem64	0Fh	F1h	11-xxx-xxx	short	mload, meu	
PSLLW mmreg, imm8	0Fh	71h	11-110-xxx	short	meu	
PSLLD mmreg1, mmreg2	0Fh	F2h	11-xxx-xxx	short	meu	
PSLLD mmreg, mem64	0Fh	F2h	11-xxx-xxx	short	meu	
PSLLD mmreg, imm8	0Fh	72h	11-110-xxx	short	meu	
PSLLQ mmreg1, mmreg2	0Fh	F3h	11-xxx-xxx	short	meu	
PSLLQ mmreg, mem64	0Fh	F3h	11-xxx-xxx	short	meu	
PSLLQ mmreg, imm8	0Fh	73h	11-110-xxx	short	meu	
PSRAW mmreg1, mmreg2	0Fh	E1h	11-xxx-xxx	short	meu	
PSRAW mmreg, mem64	0Fh	E1h	11-xxx-xxx	short	meu	
PSRAW mmreg, imm8	0Fh	71h	11-100-xxx	short	meu	
PSRAD mmreg1, mmreg2	0Fh	E2h	11-xxx-xxx	short	meu	
PSRAD mmreg, mem64	0Fh	E2h	11-xxx-xxx	short	meu	
PSRAD mmreg, imm8	0Fh	72h	11-100-xxx	short	meu	
PSRAQ mmreg1, mmreg2	0Fh	E3h	11-xxx-xxx	short	meu	
PSRAQ mmreg, mem64	0Fh	E3h	11-xxx-xxx	short	meu	
PSRAQ mmreg, imm8	0Fh	73h	11-100-xxx	short	meu	
PSRLW mmreg1, mmreg2	0Fh	D1h	11-xxx-xxx	short	meu	
PSRLW mmreg, mem64	0Fh	D1h	11-xxx-xxx	short	meu	
PSRLW mmreg, imm8	0Fh	71h	11-010-xxx	short	meu	
PSRLD mmreg1, mmreg2	0Fh	D2h	11-xxx-xxx	short	meu	
PSRLD mmreg, mem64	0Fh	D2h	11-xxx-xxx	short	meu	
PSRLD mmreg, imm8	0Fh	72h	11-010-xxx	short	meu	
PSRLQ mmreg1, mmreg2	0Fh	D3h	11-xxx-xxx	short	meu	
PSRLQ mmreg, mem64	0Fh	D3h	11-xxx-xxx	short	meu	

Note:

* Bits 2, 1, and 0 of the modR/M byte select the integer register.

Table 12. MMX™ Instructions (continued)

Instruction Mnemonic	Prefix Byte(s)	First Byte	ModR/M Byte	Decode Type	RISC86 [®] Opcodes	Note
PSRLQ mmreg, imm8	0Fh	73h	11-010-xxx	short	meu	
PSUBB mmreg1, mmreg2	0Fh	F8h	11-xxx-xxx	short	meu	
PSUBB mmreg, mem64	0Fh	F8h	mm-xxx-xxx	short	mload, meu	
PSUBD mmreg1, mmreg2	0Fh	FAh	11-xxx-xxx	short	meu	
PSUBD mmreg, mem64	0Fh	FAh	mm-xxx-xxx	short	mload, meu	
PSUBSB mmreg1, mmreg2	0Fh	E8h	11-xxx-xxx	short	meu	
PSUBSB mmreg, mem64	0Fh	E8h	mm-xxx-xxx	short	mload, meu	
PSUBSW mmreg1, mmreg2	0Fh	E9h	11-xxx-xxx	short	meu	
PSUBSW mmreg, mem64	0Fh	E9h	mm-xxx-xxx	short	mload, meu	
PSUBUSB mmreg1, mmreg2	0Fh	D8h	11-xxx-xxx	short	meu	
PSUBUSB mmreg, mem64	0Fh	D8h	mm-xxx-xxx	short	mload, meu	
PSUBUSW mmreg1, mmreg2	0Fh	D9h	11-xxx-xxx	short	meu	
PSUBUSW mmreg, mem64	0Fh	D9h	mm-xxx-xxx	short	mload, meu	
PSUBW mmreg1, mmreg2	0Fh	F9h	11-xxx-xxx	short	meu	
PSUBW mmreg, mem64	0Fh	F9h	mm-xxx-xxx	short	mload, meu	
PUNPCKHBW mmreg1, mmreg2	0Fh	68h	11-xxx-xxx	short	meu	
PUNPCKHBW mmreg, mem64	0Fh	68h	mm-xxx-xxx	short	mload, meu	
PUNPCKHWD mmreg1, mmreg2	0Fh	69h	11-xxx-xxx	short	meu	
PUNPCKHWD mmreg, mem64	0Fh	69h	mm-xxx-xxx	short	mload, meu	
PUNPCKHDQ mmreg1, mmreg2	0Fh	6Ah	11-xxx-xxx	short	meu	
PUNPCKHDQ mmreg, mem64	0Fh	6Ah	mm-xxx-xxx	short	mload, meu	
PUNPCKLBW mmreg1, mmreg2	0Fh	60h	11-xxx-xxx	short	meu	
PUNPCKLBW mmreg, mem64	0Fh	60h	mm-xxx-xxx	short	mload, meu	
PUNPCKLWD mmreg1, mmreg2	0Fh	61h	11-xxx-xxx	short	meu	
PUNPCKLWD mmreg, mem64	0Fh	61h	mm-xxx-xxx	short	mload, meu	
PUNPCKLDQ mmreg1, mmreg2	0Fh	62h	11-xxx-xxx	short	meu	
PUNPCKLDQ mmreg, mem64	0Fh	62h	mm-xxx-xxx	short	mload, meu	
PXOR mmreg1, mmreg2	0Fh	EFh	11-xxx-xxx	short	meu	
PXOR mmreg, mem64	0Fh	EFh	mm-xxx-xxx	short	mload, meu	
Note:						
* Bits 2, 1, and 0 of the modR/M byte select the integer register.						

4 Logic Symbol Diagram

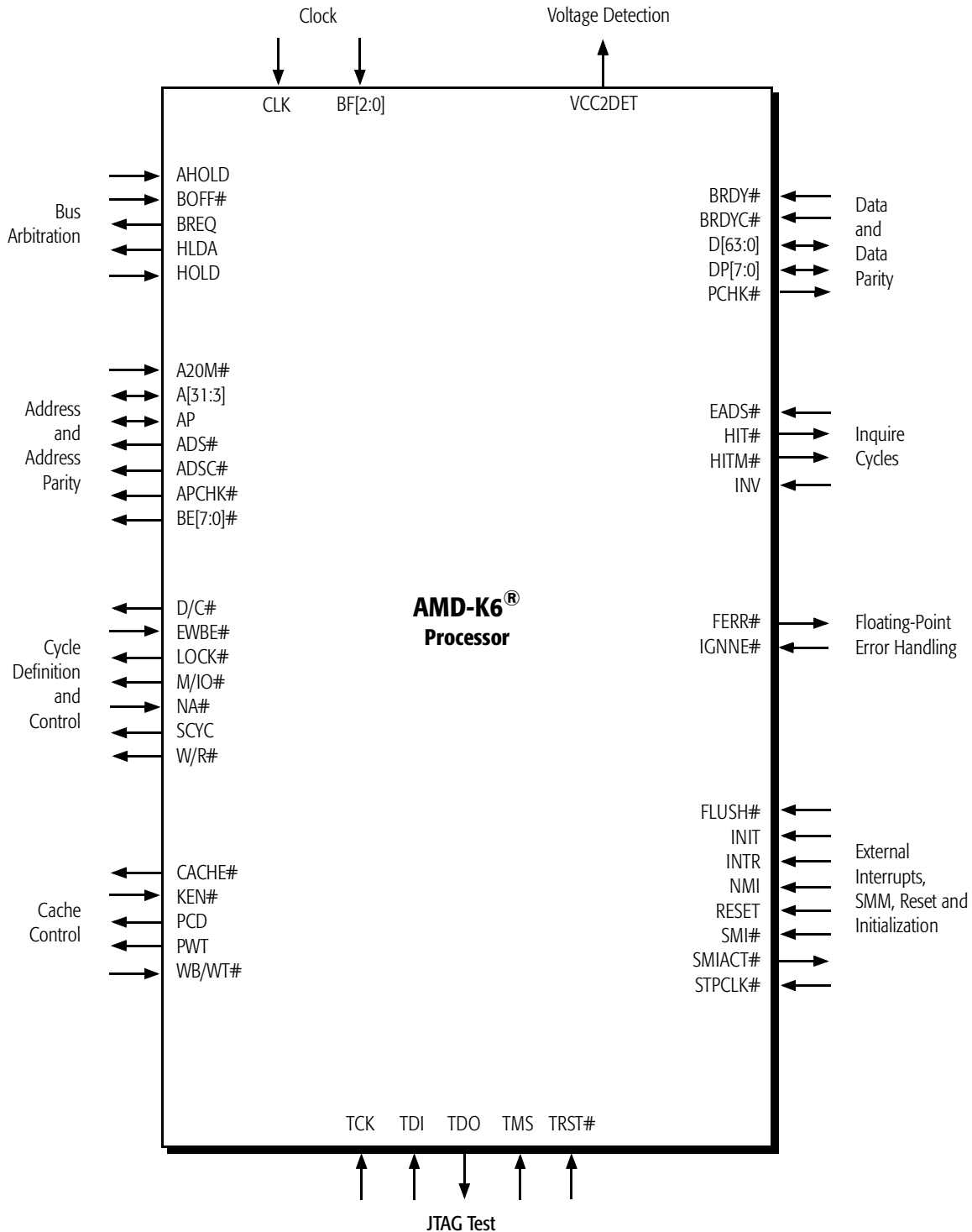

5 Signal Descriptions

5.1 A20M# (Address Bit 20 Mask)

Input

Summary

A20M# is used to simulate the behavior of the 8086 when running in Real mode. The assertion of A20M# causes the processor to force bit 20 of the physical address to 0 prior to accessing the cache or driving out a memory bus cycle. The clearing of address bit 20 maps addresses that wrap above 1 Mbyte to addresses below 1 Mbyte.

Sampled

The processor samples A20M# as a level-sensitive input on every clock edge. The system logic can drive the signal either synchronously or asynchronously. If it is asserted asynchronously, it must be asserted for a minimum pulse width of two clocks.

The following list explains the effects of the processor sampling A20M# asserted under various conditions:

- Inquire cycles and writeback cycles are not affected by the state of A20M#.
- The assertion of A20M# in System Management Mode (SMM) is ignored.
- When A20M# is sampled asserted in Protected mode, it causes unpredictable processor operation. A20M# is only defined in Real mode.
- To ensure that A20M# is recognized before the first ADS# occurs following the negation of RESET, A20M# must be sampled asserted on the same clock edge that RESET is sampled negated or on one of the two subsequent clock edges.
- To ensure A20M# is recognized before the execution of an instruction, a serializing instruction must be executed between the instruction that asserts A20M# and the targeted instruction.

5.2 A[31:3] (Address Bus)

A[31:5] Bidirectional, A[4:3] Output

Summary

A[31:3] contain the physical address for the current bus cycle. The processor drives addresses on A[31:3] during memory and I/O cycles, and cycle definition information during special bus cycles. The processor samples addresses on A[31:5] during inquire cycles.

Driven, Sampled, and Floated

As Outputs: A[31:3] are driven valid off the same clock edge as ADS# and remain in the same state until the clock edge on which NA# or the last expected BRDY# of the cycle is sampled asserted. A[31:3] are driven during memory cycles, I/O cycles, special bus cycles, and interrupt acknowledge cycles. The processor continues to drive the address bus while the bus is idle.

As Inputs: The processor samples A[31:5] during inquire cycles on the clock edge on which EADS# is sampled asserted. Even though A4 and A3 are not used during the inquire cycle, they must be driven to a valid state and must meet the same timings as A[31:5].

A[31:3] are floated off the clock edge that AHOLD or BOFF# is sampled asserted and off the clock edge that the processor asserts HLDA in recognition of HOLD.

The processor resumes driving A[31:3] off the clock edge on which the processor samples AHOLD or BOFF# negated and off the clock edge on which the processor negates HLDA.

5.3 ADS# (Address Strobe)

Output

Summary

The assertion of ADS# indicates the beginning of a new bus cycle. The address bus and all cycle definition signals corresponding to this bus cycle are driven valid off the same clock edge as ADS#.

Driven and Floated

ADS# is asserted for one clock at the beginning of each bus cycle. For non-pipelined cycles, ADS# can be asserted as early as the clock edge after the clock edge on which the last expected BRDY# of the cycle is sampled asserted, resulting in a single idle state between cycles. For pipelined cycles if the processor is prepared to start a new cycle, ADS# can be asserted as early as one clock edge after NA# is sampled asserted.

If AHOLD is sampled asserted, ADS# is only driven in order to perform a writeback cycle due to an inquire cycle that hits a modified cache line.

The processor floats ADS# off the clock edge that BOFF# is sampled asserted and off the clock edge that the processor asserts HLDA in recognition of HOLD.

5.4 ADSC# (Address Strobe Copy)

Output

Summary

ADSC# has the identical function and timing as ADS#. In the event ADS# becomes too heavily loaded due to a large fanout in a system, ADSC# can be used to split the load across two outputs, which improves timing.

5.5 AHOLD (Address Hold)

Input

Summary

AHOLD can be asserted by the system to initiate one or more inquire cycles. To allow the system to drive the address bus during an inquire cycle, the processor floats A[31:3] and AP off the clock edge on which AHOLD is sampled asserted. The data bus and all other control and status signals remain under the control of the processor and are not floated. This allows a bus cycle that is in progress when AHOLD is sampled asserted to continue to completion. The processor resumes driving the address bus off the clock edge on which AHOLD is sampled negated.

If AHOLD is sampled asserted, ADS# is only asserted in order to perform a writeback cycle due to an inquire cycle that hits a modified cache line.

Sampled

The processor samples AHOLD on every clock edge. AHOLD is recognized while INIT and RESET are sampled asserted.

5.6 AP (Address Parity)

Bidirectional

Summary

AP contains the even parity bit for cache line addresses driven and sampled on A[31:5]. Even parity means that the total number of 1 bits on AP and A[31:5] is even. (A4 and A3 are not used for the generation or checking of address parity because these bits are not required to address a cache line.) AP is driven by the processor during processor-initiated cycles and is sampled by the processor during inquire cycles. If AP does not reflect even parity during an inquire cycle, the processor asserts APCHK# to indicate an address bus parity check. The processor does not take an internal exception as the result of detecting an address bus parity check, and system logic must respond appropriately to the assertion of this signal.

Driven, Sampled, and Floated

As an Output: The processor drives AP valid off the clock edge on which ADS# is asserted until the clock edge on which NA# or the last expected BRDY# of the cycle is sampled asserted. AP is driven during memory cycles, I/O cycles, special bus cycles, and interrupt acknowledge cycles. The processor continues to drive AP while the bus is idle.

As an Input: The processor samples AP during inquire cycles on the clock edge on which EADS# is sampled asserted.

The processor floats AP off the clock edge that AHOLD or BOFF# is sampled asserted and off the clock edge that the processor asserts HLDA in recognition of HOLD.

The processor resumes driving AP off the clock edge on which the processor samples AHOLD or BOFF# negated and off the clock edge on which the processor negates HLDA.

5.7 APCHK# (Address Parity Check)

Output

Summary

If the processor detects an address parity error during an inquire cycle, APCHK# is asserted for one clock. The processor does not take an internal exception as the result of detecting an address bus parity check, and system logic must respond appropriately to the assertion of this signal.

The processor ensures that APCHK# does not glitch, enabling the signal to be used as a clocking source for system logic.

Driven

APCHK# is driven valid the clock edge after the clock edge on which the processor samples EADS# asserted. It is negated off the next clock edge.

APCHK# is always driven except in Tri-State Test mode.

5.8 BE[7:0]# (Byte Enables)

Output

Summary

BE[7:0]# are used by the processor to indicate the valid data bytes during a write cycle and the requested data bytes during a read cycle. The byte enables can be used to derive address bits A[2:0], which are not physically part of the processor's address bus. The processor checks and generates valid data parity for the data bytes that are valid as defined by the byte enables. The eight byte enables correspond to the eight bytes of the data bus as follows:

- BE7#: D[63:56]
- BE6#: D[55:48]
- BE5#: D[47:40]
- BE4#: D[39:32]
- BE3#: D[31:24]
- BE2#: D[23:16]
- BE1#: D[15:8]
- BE0#: D[7:0]

The processor expects data to be driven by the system logic on all eight bytes of the data bus during a burst cache-line read cycle, independent of the byte enables that are asserted.

The byte enables are also used to distinguish between special bus cycles as defined in Table 19 on page 119.

Driven and Floated

BE[7:0]# are driven off the same clock edge as ADS# and remain in the same state until the clock edge on which NA# or the last expected BRDY# of the cycle is sampled asserted. BE[7:0]# are driven during memory cycles, I/O cycles, special bus cycles, and interrupt acknowledge cycles.

The processor floats BE[7:0]# off the clock edge that BOFF# is sampled asserted and off the clock edge that the processor asserts HLDA in recognition of HOLD. Unlike the address bus, BE[7:0]# are not floated in response to AHOLD.

5.9 BF[2:0] (Bus Frequency)

Inputs, Internal Pullups

Summary

BF[2:0] determine the internal operating frequency of the processor. The frequency of the CLK input signal is multiplied internally by a ratio determined by the state of these signals as defined in Table 13. BF[2:0] have weak internal pullups and default to the 3.5 multiplier if left unconnected.

Table 13. Processor-to-Bus Clock Ratios

State of BF[2:0] Inputs	Processor-Clock to Bus-Clock Ratio
100b	2.5x
101b	3.0x
110b	2.0x
111b	3.5x
000b	4.5x
001b	5.0x
010b	4.0x
011b	5.5x

Sampled

BF[2:0] are sampled during the falling transition of RESET. They must meet a minimum setup time of 1.0 ms and a minimum hold time of two clocks relative to the negation of RESET.

5.10 BOFF# (Backoff)

Input

Summary

If BOFF# is sampled asserted, the processor unconditionally aborts any cycles in progress and transitions to a bus hold state by floating the following signals: A[31:3], ADS#, ADSC#, AP, BE[7:0]#, CACHE#, D[63:0], D/C#, DP[7:0], LOCK#, M/IO#, PCD, PWT, SCYC, and W/R#. These signals remain floated until BOFF# is sampled negated. This allows an alternate bus master or the system to control the bus.

When BOFF# is sampled negated, any processor cycle that was aborted due to the assertion of BOFF# is restarted from the beginning of the cycle, regardless of the number of transfers that were completed. If BOFF# is sampled asserted on the same clock edge as BRDY# of a bus cycle of any length, then BOFF# takes precedence over the BRDY#. In this case, the cycle is aborted and restarted after BOFF# is sampled negated.

Sampled

BOFF# is sampled on every clock edge. The processor floats its bus signals off the clock edge on which BOFF# is sampled asserted. These signals remain floated until the clock edge on which BOFF# is sampled negated.

BOFF# is recognized while INIT and RESET are sampled asserted.

5.11 BRDY# (Burst Ready)

Input, Internal Pullup

Summary

BRDY# is asserted to the processor by system logic to indicate either that the data bus is being driven with valid data during a read cycle or that the data bus has been latched during a write cycle. If necessary, the system logic can insert bus cycle wait states by negating BRDY# until it is ready to continue the data transfer. BRDY# is also used to indicate the completion of special bus cycles.

Sampled

BRDY# is sampled every clock edge within a bus cycle starting with the clock edge after the clock edge that negates ADS#. BRDY# is ignored while the bus is idle. The processor samples the following inputs on the clock edge on which BRDY# is sampled asserted: D[63:0], DP[7:0], and KEN# during read cycles, EWBE# during write cycles, and WB/WT# during read and write cycles. If NA# is sampled asserted prior to BRDY#, then KEN# and WB/WT# are sampled on the clock edge on which NA# is sampled asserted.

The number of times the processor expects to sample BRDY# asserted depends on the type of bus cycle, as follows:

- One time for a single-transfer cycle, a special bus cycle, or each of two cycles in an interrupt acknowledge sequence
- Four times for a burst cycle (once for each data transfer)

BRDY# can be held asserted for four consecutive clocks throughout the four transfers of the burst, or it can be negated to insert wait states.

5.12 BRDYC# (Burst Ready Copy)

Input, Internal Pullup

Summary

BRDYC# has the identical function as BRDY#. In the event BRDY# becomes too heavily loaded due to a large fanout or loading in a system, BRDYC# can be used to reduce this loading, which improves timing.

In addition, BRDYC# is sampled when RESET is negated to configure the drive strength of A[20:3], ADS#, HITM#, and W/R#. If BRDYC# is 0 during the falling transition of RESET, these particular outputs are configured using higher drive strengths than the standard strength. If BRDYC# is 1 during the falling transition of RESET, the standard strength is selected.

Sampled

BRDYC# is sampled every clock edge within a bus cycle starting with the clock edge after the clock edge that negates ADS#.

BRDYC# is also sampled during the falling transition of RESET. If RESET is driven synchronously, BRDYC# must meet the specified hold time relative to the negation of RESET. If RESET is driven asynchronously, the minimum setup and hold time for BRDYC# relative to the negation of RESET is two clocks.

5.13 BREQ (Bus Request)

Output

Summary

BREQ is asserted by the processor to request the bus in order to complete an internally pending bus cycle. The system logic can use BREQ to arbitrate among the bus participants. If the processor does not own the bus, BREQ is asserted until the processor gains access to the bus in order to begin the pending cycle or until the processor no longer needs to run the pending cycle. If the processor currently owns the bus, BREQ is asserted with ADS#. The processor asserts BREQ for each assertion of ADS# but does not necessarily assert ADS# for each assertion of BREQ.

Driven

BREQ is asserted off the same clock edge on which ADS# is asserted. BREQ can also be asserted off any clock edge, independent of the assertion of ADS#. BREQ can be negated one clock edge after it is asserted.

The processor always drives BREQ except in Tri-State Test mode.

5.14 CACHE# (Cacheable Access)

Output

Summary

For reads, CACHE# is asserted to indicate the cacheability of the current bus cycle. In addition, if the processor samples KEN# asserted, which indicates the driven address is cacheable, the cycle is a 32-byte burst read cycle. For write cycles, CACHE# is asserted to indicate the current bus cycle is a modified cache-line writeback. KEN# is ignored during writebacks. If CACHE# is not asserted, or if KEN# is sampled negated during a read cycle, the cycle is not cacheable and defaults to a single-transfer cycle.

Driven and Floated

CACHE# is driven off the same clock edge as ADS# and remains in the same state until the clock edge on which NA# or the last expected BRDY# of the cycle is sampled asserted.

CACHE# is floated off the clock edge that BOFF# is sampled asserted and off the clock edge that the processor asserts HLDA in recognition of HOLD.

5.15 CLK (Clock)

Input

Summary

The CLK signal is the bus clock for the processor and is the reference for all signal timings under normal operation (except for TDI, TDO, TMS, and TRST#). BF[2:0] determine the internal frequency multiplier applied to CLK to obtain the processor's core operating frequency. (See "BF[2:0] (Bus Frequency)" on page 86 for a list of the processor-to-bus clock ratios.)

Sampled

The CLK signal must be stable a minimum of 1.0 ms prior to the negation of RESET to ensure the proper operation of the processor. See "CLK Switching Characteristics" on page 241 for details regarding the CLK specifications.

5.16 D/C# (Data/Code)

Output

Summary

The processor drives D/C# during a memory bus cycle to indicate whether it is addressing data or executable code. D/C# is also used to define other bus cycles, including interrupt acknowledge and special cycles. (See Table 19 on page 119 for more details.)

Driven and Floated

D/C# is driven off the same clock edge as ADS# and remains in the same state until the clock edge on which NA# or the last expected BRDY# of the cycle is sampled asserted. D/C# is driven during memory cycles, I/O cycles, special bus cycles, and interrupt acknowledge cycles.

D/C# is floated off the clock edge that BOFF# is sampled asserted and off the clock edge that the processor asserts HLDA in recognition of HOLD.

5.17 D[63:0] (Data Bus)

Bidirectional

Summary

D[63:0] represent the processor's 64-bit data bus. Each of the eight bytes of data that comprise this bus is qualified as valid by its corresponding byte enable. (See "BE[7:0]# (Byte Enables)" on page 85.)

Driven, Sampled, and Floated

As Outputs: For single-transfer write cycles, the processor drives D[63:0] with valid data one clock edge after the clock edge on which ADS# is asserted and D[63:0] remain in the same state until the clock edge on which BRDY# is sampled asserted. If the cycle is a writeback—in which case four, 8-byte transfers occur—D[63:0] are driven one clock edge after the clock edge on which ADS# is asserted and are subsequently changed off the clock edge on which each BRDY# assertion of the burst cycle is sampled.

If the assertion of ADS# represents a pipelined write cycle that follows a read cycle, the processor does not drive D[63:0] until it is certain that contention on the data bus will not occur. In this case, D[63:0] are driven the clock edge after the last expected BRDY# of the previous cycle is sampled asserted.

As Inputs: During read cycles, the processor samples D[63:0] on the clock edge on which BRDY# is sampled asserted.

The processor always floats D[63:0] except when they are being driven during a write cycle as described above. In addition, D[63:0] are floated off the clock edge that BOFF# is sampled asserted and off the clock edge that the processor asserts HLDA in recognition of HOLD.

5.18 DP[7:0] (Data Parity)

Bidirectional

Summary

DP[7:0] are even parity bits for each valid byte of data—as defined by BE[7:0]#—driven and sampled on the D[63:0] data bus. (Even parity means that the total number of 1 bits within each byte of data and its respective data parity bit is even.) DP[7:0] are driven by the processor during write cycles and sampled by the processor during read cycles. If the processor detects bad parity on any valid byte of data during a read cycle, PCHK# is asserted for one clock beginning the clock edge after BRDY# is sampled asserted. The processor does not take an internal exception as the result of detecting a data parity check, and system logic must respond appropriately to the assertion of this signal.

The eight data parity bits correspond to the eight bytes of the data bus as follows:

- DP7: D[63:56]
- DP6: D[55:48]
- DP5: D[47:40]
- DP4: D[39:32]
- DP3: D[31:24]
- DP2: D[23:16]
- DP1: D[15:8]
- DP0: D[7:0]

For systems that do not support data parity, DP[7:0] should be connected to V_{CC3} through pullup resistors.

Driven, Sampled, and Floated

As Outputs: For single-transfer write cycles, the processor drives DP[7:0] with valid parity one clock edge after the clock edge on which ADS# is asserted and DP[7:0] remain in the same state until the clock edge on which BRDY# is sampled asserted. If the cycle is a writeback, DP[7:0] are driven one clock edge after the clock edge on which ADS# is asserted and are subsequently changed off the clock edge on which each BRDY# assertion of the burst cycle is sampled.

As Inputs: During read cycles, the processor samples DP[7:0] on the clock edge BRDY# is sampled asserted.

The processor always floats DP[7:0] except when they are being driven during a write cycle as described above. In addition, DP[7:0] are floated off the clock edge that BOFF# is sampled asserted and off the clock edge that the processor asserts HLDA in recognition of HOLD.

5.19 EADS# (External Address Strobe)

Input

Summary

System logic asserts EADS# during a cache inquire cycle to indicate that the address bus contains a valid address. EADS# can only be driven after the system logic has taken control of the address bus by asserting AHOLD or BOFF# or by receiving HLDA. The processor responds to the sampling of EADS# and the address bus by driving HIT#, which indicates if the inquired cache line exists in the processor's cache, and HITM#, which indicates if it is in the modified state.

Sampled

If AHOLD or BOFF# is asserted by the system logic in order to execute a cache inquire cycle, the processor begins sampling EADS# two clock edges after AHOLD or BOFF# is sampled asserted. If the system logic asserts HOLD in order to execute a cache inquire cycle, the processor begins sampling EADS# two clock edges after the clock edge HLDA is asserted by the processor.

EADS# is ignored during the following conditions:

- One clock edge after the clock edge on which EADS# is sampled asserted
- Two clock edges after the clock edge on which ADS# is asserted
- When the processor is driving the address bus
- When the processor asserts HITM#

5.20 EWBE# (External Write Buffer Empty)

Input

Summary

The system logic can negate EWBE# to the processor to indicate that its external write buffers are full and that additional data cannot be stored at this time. This causes the processor to delay the following activities until EWBE# is sampled asserted:

- The commitment of write hit cycles to cache lines in the modified state or exclusive state in the processor's cache
- The decode and execution of an instruction that follows a currently-executing serializing instruction
- The assertion or negation of SMIACT#
- The entering of the Halt state and the Stop Grant state

Negating EWBE# does not prevent the completion of any type of cycle that is currently in progress.

Sampled

The processor samples EWBE# on each clock edge that BRDY# is sampled asserted during all memory write cycles (except writeback cycles), I/O write cycles, and special bus cycles.

If EWBE# is sampled negated, it is sampled on every clock edge until it is asserted, and then it is ignored until BRDY# is sampled asserted in the next write cycle or special cycle.

5.21 FERR# (Floating-Point Error)

Output

Summary

The assertion of FERR# indicates the occurrence of an unmasked floating-point exception resulting from the execution of a floating-point instruction. This signal is provided to allow the system logic to handle this exception in a manner consistent with IBM-compatible PC/AT systems. See “Handling Floating-Point Exceptions” on page 189 for a system logic implementation that supports floating-point exceptions.

The state of the numeric error (NE) bit in CR0 does not affect the FERR# signal.

The processor ensures that FERR# does not glitch, enabling the signal to be used as a clocking source for system logic.

Driven

The processor asserts FERR# on the instruction boundary of the next floating-point instruction, MMX instruction, or WAIT instruction that occurs following the floating-point instruction that caused the unmasked floating-point exception—that is, FERR# is not asserted at the time the exception occurs. The IGNNE# signal does not affect the assertion of FERR#.

FERR# is negated during the following conditions:

- Following the successful execution of the floating-point instructions FCLEX, FINIT, FSAVE, and FSTENV
- Under certain circumstances, following the successful execution of the floating-point instructions FLDCW, FLDENV, and FRSTOR, which load the floating-point status word or the floating-point control word
- Following the falling transition of RESET

FERR# is always driven except in Tri-State Test mode.

See “IGNNE# (Ignore Numeric Exception)” on page 100 for more details on floating-point exceptions.

5.22 FLUSH# (Cache Flush)

Input

Summary

In response to sampling FLUSH# asserted, the processor writes back any data cache lines that are in the modified state, invalidates all lines in the instruction and data caches, and then executes a flush acknowledge special cycle. (See Table 19 on page 119 for the bus definition of special cycles.)

In addition, FLUSH# is sampled when RESET is negated to determine if the processor enters Tri-State Test mode. If FLUSH# is 0 during the falling transition of RESET, the processor enters Tri-State Test mode instead of performing the normal RESET functions.

Sampled

FLUSH# is sampled and latched as a falling edge-sensitive signal. During normal operation (not RESET), FLUSH# is sampled on every clock edge but is not recognized until the next instruction boundary. If FLUSH# is asserted synchronously, it can be asserted for a minimum of one clock. If FLUSH# is asserted asynchronously, it must have been negated for a minimum of two clocks, followed by an assertion of a minimum of two clocks.

FLUSH# is also sampled during the falling transition of RESET. If RESET and FLUSH# are driven synchronously, FLUSH# is sampled on the clock edge prior to the clock edge on which RESET is sampled negated. If RESET is driven asynchronously, the minimum setup and hold time for FLUSH#, relative to the negation of RESET, is two clocks.

5.23 HIT# (Inquire Cycle Hit)

Output

Summary

The processor asserts HIT# during an inquire cycle to indicate that the cache line is valid within the processor's instruction or data cache (also known as a cache hit). The cache line can be in the modified, exclusive, or shared state.

Driven

HIT# is always driven—except in Tri-State Test mode—and only changes state the clock edge after the clock edge on which EADS# is sampled asserted. It is driven in the same state until the next inquire cycle.

5.24 HITM# (Inquire Cycle Hit To Modified Line)

Output

Summary

The processor asserts HITM# during an inquire cycle to indicate that the cache line exists in the processor's data cache in the modified state. The processor performs a writeback cycle as a result of this cache hit. If an inquire cycle hits a cache line that is currently being written back, the processor asserts HITM# but does not execute another writeback cycle. The system logic must not expect the processor to assert ADS# each time HITM# is asserted.

Driven

HITM# is always driven—except in Tri-State Test mode—and, in particular, is driven to represent the result of an inquire cycle the clock edge after the clock edge on which EADS# is sampled asserted. If HITM# is negated in response to the inquire address, it remains negated until the next inquire cycle. If HITM# is asserted in response to the inquire address, it remains asserted throughout the writeback cycle and is negated one clock edge after the last BRDY# of the writeback is sampled asserted.

5.25 HLDA (Hold Acknowledge)

Output

Summary

When HOLD is sampled asserted, the processor completes the current bus cycles, floats the processor bus, and asserts HLDA in an acknowledgment that these events have been completed. The processor does not assert HLDA until the completion of a locked sequence of cycles. While HLDA is asserted, another bus master can drive cycles on the bus, including inquire cycles to the processor. The following signals are floated when HLDA is asserted: A[31:3], ADS#, ADSC#, AP, BE[7:0]#, CACHE#, D[63:0], D/C#, DP[7:0], LOCK#, M/IO#, PCD, PWT, SCYC, and W/R#.

The processor ensures that HLDA does not glitch.

Driven

HLDA is always driven except in Tri-State Test mode. If a processor cycle is in progress while HOLD is sampled asserted, HLDA is asserted one clock edge after the last BRDY# of the cycle is sampled asserted. If the bus is idle, HLDA is asserted one clock edge after HOLD is sampled asserted. HLDA is negated one clock edge after the clock edge on which HOLD is sampled negated.

The assertion of HLDA is independent of the sampled state of BOFF#.

The processor floats the bus every clock in which HLDA is asserted.

5.26 HOLD (Bus Hold Request)

Input

Summary

The system logic can assert HOLD to gain control of the processor's bus. When HOLD is sampled asserted, the processor completes the current bus cycles, floats the processor bus, and asserts HLDA in an acknowledgment that these events have been completed.

Sampled

The processor samples HOLD on every clock edge. If a processor cycle is in progress while HOLD is sampled asserted, HLDA is asserted one clock edge after the last BRDY# of the cycle is sampled asserted. If the bus is idle, HLDA is asserted one clock edge after HOLD is sampled asserted. HOLD is recognized while INIT and RESET are sampled asserted.

5.27 IGNNE# (Ignore Numeric Exception)

Input

Summary

IGNNE#, in conjunction with the numeric error (NE) bit in CR0, is used by the system logic to control the effect of an unmasked floating-point exception on a previous floating-point instruction during the execution of a floating-point instruction, MMX instruction, or the WAIT instruction—hereafter referred to as the target instruction.

If an unmasked floating-point exception is pending and the target instruction is considered error-sensitive, then the relationship between NE and IGNNE# is as follows:

- If NE = 0, then:
 - If IGNNE# is sampled asserted, the processor ignores the floating-point exception and continues with the execution of the target instruction.
 - If IGNNE# is sampled negated, the processor waits until it samples IGNNE#, INTR, SMI#, NMI, or INIT asserted.
 - If IGNNE# is sampled asserted while waiting, the processor ignores the floating-point exception and continues with the execution of the target instruction.
 - If INTR, SMI#, NMI, or INIT is sampled asserted while waiting, the processor handles its assertion appropriately.
- If NE = 1, the processor invokes the INT 10h exception handler.

If an unmasked floating-point exception is pending and the target instruction is considered error-insensitive, then the processor ignores the floating-point exception and continues with the execution of the target instruction.

FERR# is not affected by the state of the NE bit or IGNNE#. FERR# is always asserted at the instruction boundary of the target instruction that follows the floating-point instruction that caused the unmasked floating-point exception.

This signal is provided to allow the system logic to handle exceptions in a manner consistent with IBM-compatible PC/AT systems.

Sampled The processor samples IGNNE# as a level-sensitive input on every clock edge. The system logic can drive the signal either synchronously or asynchronously. If it is asserted asynchronously, it must be asserted for a minimum pulse width of two clocks.

5.28 INIT (Initialization)

Input

Summary The assertion of INIT causes the processor to empty its pipelines, to initialize most of its internal state, and to branch to address FFFF_FFF0h—the same instruction execution starting point used after RESET. Unlike RESET, the processor preserves the contents of its caches, the floating-point state, the MMX state, Model-Specific Registers, the CD and NW bits of the CR0 register, and other specific internal resources.

INIT can be used as an accelerator for 80286 code that requires a reset to exit from Protected mode back to Real mode.

Sampled INIT is sampled and latched as a rising edge-sensitive signal. INIT is sampled on every clock edge but is not recognized until the next instruction boundary. During an I/O write cycle, it must be sampled asserted a minimum of three clock edges before BRDY# is sampled asserted if it is to be recognized on the boundary between the I/O write instruction and the following instruction.

If INIT is asserted synchronously, it can be asserted for a minimum of one clock. If it is asserted asynchronously, it must have been negated for a minimum of two clocks, followed by an assertion of a minimum of two clocks.

5.29 INTR (Maskable Interrupt)

Input

Summary

INTR is the system's maskable interrupt input to the processor. When the processor samples and recognizes INTR asserted, the processor executes a pair of interrupt acknowledge bus cycles and then jumps to the interrupt service routine specified by the interrupt number that was returned during the interrupt acknowledge sequence. The processor only recognizes INTR if the interrupt flag (IF) in the EFLAGS register equals 1.

Sampled

The processor samples INTR as a level-sensitive input on every clock edge, but the interrupt request is not recognized until the next instruction boundary. The system logic can drive INTR either synchronously or asynchronously. If it is asserted asynchronously, it must be asserted for a minimum pulse width of two clocks. In order to be recognized, INTR must remain asserted until an interrupt acknowledge sequence is complete.

5.30 INV (Invalidation Request)

Input

Summary

During an inquire cycle, the state of INV determines whether an addressed cache line that is found in the processor's instruction or data cache transitions to the invalid state or the shared state.

If INV is sampled asserted during an inquire cycle, the processor transitions the cache line (if found) to the invalid state, regardless of its previous state. If INV is sampled negated during an inquire cycle, the processor transitions the cache line (if found) to the shared state. In either case, if the cache line is found in the modified state, the processor writes it back to memory before changing its state.

Sampled

INV is sampled on the clock edge on which EADS# is sampled asserted.

5.31 KEN# (Cache Enable)

Input

Summary

If KEN# is sampled asserted, it indicates that the address presented by the processor is cacheable. If KEN# is sampled asserted and the processor intends to perform a cache-line fill (signified by the assertion of CACHE#), the processor executes a 32-byte burst read cycle and expects to sample BRDY# asserted a total of four times. If KEN# is sampled negated during a read cycle, a single-transfer cycle is executed and the processor does not cache the data. For write cycles, CACHE# is asserted to indicate the current bus cycle is a modified cache-line writeback. KEN# is ignored during writebacks.

If PCD is asserted during a bus cycle, the processor does not cache any data read during that cycle, regardless of the state of KEN#. (See “PCD (Page Cache Disable)” on page 107 for more details.)

If the processor has sampled the state of KEN# during a cycle, and that cycle is aborted due to the sampling of BOFF# asserted, the system logic must ensure that KEN# is sampled in the same state when the processor restarts the aborted cycle.

Sampled

KEN# is sampled on the clock edge on which the first BRDY# or NA# of a read cycle is sampled asserted. If the read cycle is a burst, KEN# is ignored during the last three assertions of BRDY#. KEN# is sampled during read cycles only when CACHE# is asserted.

5.32 LOCK# (Bus Lock)

Output

Summary

The processor asserts LOCK# during a sequence of bus cycles to ensure that the cycles are completed without allowing other bus masters to intervene. Locked operations consist of two to five bus cycles. LOCK# is asserted during the following operations:

- An interrupt acknowledge sequence
- Descriptor Table accesses
- Page Directory and Page Table accesses
- XCHG instruction
- An instruction with an allowable LOCK prefix

In order to ensure that locked operations appear on the bus and are visible to the entire system, any data operands addressed during a locked cycle that reside in the processor's cache are flushed and invalidated from the cache prior to the locked operation. If the cache line is in the modified state, it is written back and invalidated prior to the locked operation. Likewise, any data read during a locked operation is not cached.

The processor ensures that LOCK# does not glitch.

Driven and Floated

During a locked cycle, LOCK# is asserted off the same clock edge on which ADS# is asserted and remains asserted until the last BRDY# of the last bus cycle is sampled asserted. The processor negates LOCK# for at least one clock between consecutive sequences of locked operations to allow the system logic to arbitrate for the bus.

LOCK# is floated off the clock edge that BOFF# is sampled asserted and off the clock edge that the processor asserts HLDA in response to HOLD. When LOCK# is floated due to BOFF# sampled asserted, the system logic is responsible for preserving the lock condition while LOCK# is in the high-impedance state.

5.33 M/IO# (Memory or I/O)

Output

Summary

The processor drives M/IO# during a bus cycle to indicate whether it is addressing the memory or I/O space. If M/IO# = 1, the processor is addressing memory or a memory-mapped I/O port as the result of an instruction fetch or an instruction that loads or stores data. If M/IO# = 0, the processor is addressing an I/O port during the execution of an I/O instruction. In addition, M/IO# is used to define other bus cycles, including interrupt acknowledge and special cycles. (See Table 19 on page 119 for more details.)

Driven and Floated

M/IO# is driven off the same clock edge as ADS# and remains in the same state until the clock edge on which NA# or the last expected BRDY# of the cycle is sampled asserted. M/IO# is driven during memory cycles, I/O cycles, special bus cycles, and interrupt acknowledge cycles.

M/IO# is floated off the clock edge that BOFF# is sampled asserted and off the clock edge that the processor asserts HLDA in response to HOLD.

5.34 NA# (Next Address)

Input

Summary

System logic asserts NA# to indicate to the processor that it is ready to accept another bus cycle pipelined into the previous bus cycle. ADS#, along with address and status signals, can be asserted as early as one clock edge after NA# is sampled asserted if the processor is prepared to start a new cycle. Because the processor allows a maximum of two cycles to be in progress at a time, the assertion of NA# is sampled while two cycles are in progress but ADS# is not asserted until the completion of the first cycle.

Sampled

NA# is sampled every clock edge during bus cycles, starting one clock edge after the clock edge that negates ADS#, until the last expected BRDY# of the last executed cycle is sampled asserted (with the exception of the clock edge after the clock edge that negates the ADS# for a second pending cycle). Because the processor latches NA# when sampled, the system logic only needs to assert NA# for one clock.

5.35 NMI (Non-Maskable Interrupt)

Input

Summary

When NMI is sampled asserted, the processor jumps to the interrupt service routine defined by interrupt number 02h. Unlike the INTR signal, software cannot mask the effect of NMI if it is sampled asserted by the processor. However, NMI is temporarily masked upon entering System Management Mode (SMM). In addition, an interrupt acknowledge cycle is not executed because the interrupt number is predefined.

If NMI is sampled asserted while the processor is executing the interrupt service routine for a previous NMI, the subsequent NMI remains pending until the completion of the execution of the IRET instruction at the end of the interrupt service routine.

Sampled

NMI is sampled and latched as a rising edge-sensitive signal. During normal operation, NMI is sampled on every clock edge but is not recognized until the next instruction boundary. If it is asserted synchronously, it can be asserted for a minimum of one clock. If it is asserted asynchronously, it must have been negated for a minimum of two clocks, followed by an assertion of a minimum of two clocks.

5.36 PCD (Page Cache Disable)

Output

Summary

The processor drives PCD to indicate the operating system's specification of cacheability for the page being addressed. System logic can use PCD to control external caching. If PCD is asserted, the addressed page is not cached. If PCD is negated, the cacheability of the addressed page depends upon the state of CACHE# and KEN#.

The state of PCD depends upon the processor's operating mode and the state of certain bits in its control registers and TLB as follows:

- In Real mode, or in Protected and Virtual-8086 modes while paging is disabled (PG bit in CR0 set to 0):

PCD output = CD bit in CR0

- In Protected and Virtual-8086 modes while caching is enabled (CD bit in CR0 set to 0) and paging is enabled (PG bit in CR0 set to 1):

- For accesses to I/O space, page directory entries, and other non-paged accesses:

PCD output = PCD bit in CR3

- For accesses to 4-Kbyte page table entries or 4-Mbyte pages:

PCD output = PCD bit in page directory entry

- For accesses to 4-Kbyte pages:

PCD output = PCD bit in page table entry

Driven and Floated

PCD is driven off the same clock edge as ADS# and remains in the same state until the clock edge on which NA# or the last expected BRDY# of the cycle is sampled asserted.

PCD is floated off the clock edge that BOFF# is sampled asserted and off the clock edge that the processor asserts HLDA in response to HOLD.

5.37 PCHK# (Parity Check)

Output

Summary

The processor asserts PCHK# during read cycles if it detects an even parity error on one or more valid bytes of D[63:0] during a read cycle. (Even parity means that the total number of 1 bits within each byte of data and its respective data parity bit is even.) The processor checks data parity for the data bytes that are valid, as defined by BE[7:0]#, the byte enables.

PCHK# is always driven but is only asserted for memory and I/O read bus cycles and the second cycle of an interrupt acknowledge sequence. PCHK# is not driven during any type of write cycles or special bus cycles. The processor does not take an internal exception as the result of detecting a data parity error, and system logic must respond appropriately to the assertion of this signal.

The processor ensures that PCHK# does not glitch, enabling the signal to be used as a clocking source for system logic.

Driven

PCHK# is always driven except in Tri-State Test mode. For each BRDY# returned to the processor during a read cycle with a parity error detected on the data bus, PCHK# is asserted for one clock, one clock edge after BRDY# is sampled asserted.

5.38 PWT (Page Writethrough)

Output

Summary

The processor drives PWT to indicate the operating system's specification of the writeback state or writethrough state for the page being addressed. PWT, together with WB/WT#, specifies the data cache-line state during cacheable read misses and write hits to shared cache lines. (See "WB/WT# (Writeback or Writethrough)" on page 116 for more details.)

The state of PWT depends upon the processor's operating mode and the state of certain bits in its control registers and TLB as follows:

- In Real mode, or in Protected and Virtual-8086 modes while paging is disabled (PG bit in CR0 set to 0):

PWT output = 0 (writeback state)

- In Protected and Virtual-8086 modes while paging is enabled (PG bit in CR0 set to 1):

- For accesses to I/O space, page directory entries, and other non-paged accesses:

PWT output = PWT bit in CR3

- For accesses to 4-Kbyte page table entries or 4-Mbyte pages:

PWT output = PWT bit in page directory entry

- For accesses to 4-Kbyte pages:

PWT output = PWT bit in page table entry

Driven and Floated

PWT is driven off the same clock edge as ADS# and remains in the same state until the clock edge on which NA# or the last expected BRDY# of the cycle is sampled asserted.

PWT is floated off the clock edge that BOFF# is sampled asserted and off the clock edge that the processor asserts HLDA in response to HOLD.

5.39 RESET (Reset)

Input

Summary

When the processor samples RESET asserted, it immediately flushes and initializes all internal resources and its internal state including its pipelines and caches, the floating-point state, the MMX state, and all registers, and then the processor jumps to address FFFF_FFF0h to start instruction execution.

The signals BRDYC# and FLUSH# are sampled during the falling transition of RESET to select the drive strength of selected output signals and to invoke the Tri-State Test mode, respectively. (See these signal descriptions for more details.)

Sampled

RESET is sampled as a level-sensitive input on every clock edge. System logic can drive the signal either synchronously or asynchronously.

During the initial power-on reset of the processor, RESET must remain asserted for a minimum of 1.0 ms after CLK and V_{CC} reach specification before it is negated.

During a warm reset, while CLK and V_{CC} are within their specification, RESET must remain asserted for a minimum of 15 clocks prior to its negation.

5.40 RSVD (Reserved)

Summary

Reserved signals are a special class of pins that can be treated in one of the following ways:

- As no-connect (NC) pins, in which case these pins are left unconnected
- As pins connected to the system logic as defined by the industry-standard Pentium interface (Socket 7)
- Any combination of NC and Socket 7 pins

In any case, if the RSVD pins are treated accordingly, the normal operation of the AMD-K6 processor is not adversely affected in any manner.

See “Pin Designations” on page 269 for a list of the locations of the RSVD pins.

5.41 SCYC (Split Cycle)

Output

Summary

The processor asserts SCYC during misaligned, locked transfers on the D[63:0] data bus. The processor generates additional bus cycles to complete the transfer of misaligned data.

For purposes of bus cycles, the term *aligned* means:

- Any 1-byte transfers
- 2-byte and 4-byte transfers that lie within 4-byte address boundaries
- 8-byte transfers that lie within 8-byte address boundaries

Driven and Floated

SCYC is asserted off the same clock edge as ADS#, and negated off the clock edge on which NA# or the last expected BRDY# of the entire locked sequence is sampled asserted. SCYC is only valid during locked memory cycles.

SCYC is floated off the clock edge that BOFF# is sampled asserted and off the clock edge that the processor asserts HLDA in response to HOLD.

5.42 SMI# (System Management Interrupt)

Input, Internal Pullup

Summary

The assertion of SMI# causes the processor to enter System Management Mode (SMM). Upon recognizing SMI#, the processor performs the following actions, in the order shown:

1. Flushes its instruction pipelines
2. Completes all pending and in-progress bus cycles
3. Acknowledges the interrupt by asserting SMIACT# after sampling EWBE# asserted
4. Saves the internal processor state in SMM memory
5. Disables interrupts by clearing the interrupt flag (IF) in EFLAGS and disables NMI interrupts
6. Jumps to the entry point of the SMM service routine at the SMM base physical address which defaults to 0003_8000h in SMM memory

See “System Management Mode (SMM)” on page 193 for more details regarding SMM.

Sampled

SMI# is sampled and latched as a falling edge-sensitive signal. SMI# is sampled on every clock edge but is not recognized until the next instruction boundary. If SMI# is to be recognized on the instruction boundary associated with a BRDY#, it must be sampled asserted a minimum of three clock edges before the BRDY# is sampled asserted. If it is asserted synchronously, it can be asserted for a minimum of one clock. If it is asserted asynchronously, it must have been negated for a minimum of two clocks followed by an assertion of a minimum of two clocks.

A second assertion of SMI# while in SMM is latched but is not recognized until the SMM service routine is exited.

5.43 SMIACT# (System Management Interrupt Active)

Output

Summary

The processor acknowledges the assertion of SMI# with the assertion of SMIACT# to indicate that the processor has entered System Management Mode (SMM). The system logic can use SMIACT# to enable SMM memory. See “SMI# (System Management Interrupt)” on page 111 for more details.

See “System Management Mode (SMM)” on page 193 for more details regarding SMM.

Driven

The processor asserts SMIACT# after the last BRDY# of the last pending bus cycle is sampled asserted (including all pending write cycles) and after EWBE# is sampled asserted. SMIACT# remains asserted until after the last BRDY# of the last pending bus cycle associated with exiting SMM is sampled asserted.

SMIACT# remains asserted during any flush, internal snoop, or writeback cycle due to an inquire cycle.

5.44 STPCLK# (Stop Clock)

Input, Internal Pullup

Summary

The assertion of STPCLK# causes the processor to enter the Stop Grant state, during which the processor's internal clock is stopped. From the Stop Grant state, the processor can subsequently transition to the Stop Clock state, in which the bus clock CLK is stopped. Upon recognizing STPCLK#, the processor performs the following actions, in the order shown:

1. Flushes its instruction pipelines
2. Completes all pending and in-progress bus cycles
3. Acknowledges the STPCLK# assertion by executing a Stop Grant special bus cycle (see Table 19 on page 119)
4. Stops its internal clock after BRDY# of the Stop Grant special bus cycle is sampled asserted and after EWBE# is sampled asserted
5. Enters the Stop Clock state if the system logic stops the bus clock CLK (optional)

See “Clock Control” on page 223 for more details regarding clock control.

Sampled

STPCLK# is sampled as a level-sensitive input on every clock edge but is not recognized until the next instruction boundary. System logic can drive the signal either synchronously or asynchronously. If it is asserted asynchronously, it must be asserted for a minimum pulse width of two clocks.

STPCLK# must remain asserted until recognized, which is indicated by the completion of the Stop Grant special cycle.

5.45 TCK (Test Clock)

Input, Internal Pullup

Summary

TCK is the clock for boundary-scan testing using the Test Access Port (TAP). See “Boundary-Scan Test Access Port (TAP)” on page 205 for details regarding the operation of the TAP controller.

Sampled

The processor always samples TCK, except while TRST# is asserted.

5.46 TDI (Test Data Input)

Input, Internal Pullup

Summary

TDI is the serial test data and instruction input for boundary-scan testing using the Test Access Port (TAP). See “Boundary-Scan Test Access Port (TAP)” on page 205 for details regarding the operation of the TAP controller.

Sampled

The processor samples TDI on every rising TCK edge but only while in the Shift-IR and Shift-DR states.

5.47 TDO (Test Data Output)

Output

Summary

TDO is the serial test data and instruction output for boundary-scan testing using the Test Access Port (TAP). See “Boundary-Scan Test Access Port (TAP)” on page 205 for details regarding the operation of the TAP controller.

Driven and Floated

The processor drives TDO on every falling TCK edge but only while in the Shift-IR and Shift-DR states. TDO is floated at all other times.

5.48 TMS (Test Mode Select)

Input, Internal Pullup

Summary

TMS specifies the test function and sequence of state changes for boundary-scan testing using the Test Access Port (TAP). See “Boundary-Scan Test Access Port (TAP)” on page 205 for details regarding the operation of the TAP controller.

Sampled

The processor samples TMS on every rising TCK edge. If TMS is sampled High for five or more consecutive clocks, the TAP controller enters its Test-Logic-Reset state, regardless of the controller state. This action is the same as that achieved by asserting TRST#.

5.49 TRST# (Test Reset)

Input, Internal Pullup

Summary

The assertion of TRST# initializes the Test Access Port (TAP) by resetting its state machine to the Test-Logic-Reset state. See “Boundary-Scan Test Access Port (TAP)” on page 205 for details regarding the operation of the TAP controller.

Sampled

TRST# is a completely asynchronous input that does not require a minimum setup and hold time relative to TCK. See Table 54 on page 253 for the minimum pulse width requirement.

5.50 VCC2DET (V_{CC2} Detect)

Output

Summary

VCC2DET is tied to V_{SS} (logic level 0) to indicate to the system logic that it must supply the specified processor core voltage to the V_{CC2} pins. The V_{CC2} pins supply voltage to the processor core, independent of the voltage supplied to the I/O buffers on the V_{CC3} pins.

Driven

VCC2DET always equals 0 and is never floated—even during Tri-State Test mode.

5.51 W/R# (Write/Read)

Output

Summary

The processor drives W/R# to indicate whether it is performing a write or a read cycle on the bus. In addition, W/R# is used to define other bus cycles, including interrupt acknowledge and special cycles (see Table 19 on page 119 for more details).

Driven and Floated

W/R# is driven off the same clock edge as ADS# and remains in the same state until the clock edge on which NA# or the last expected BRDY# of the cycle is sampled asserted. W/R# is driven during memory cycles, I/O cycles, special bus cycles, and interrupt acknowledge cycles.

W/R# is floated off the clock edge that BOFF# is sampled asserted and off the clock edge that the processor asserts HLDA in response to HOLD.

5.52 WB/WT# (Writeback or Writethrough)

Input

Summary

WB/WT#, together with PWT, specifies the data cache-line state during cacheable read misses and write hits to shared cache lines.

If WB/WT# = 0 or PWT = 1 during a cacheable read miss or write hit to a shared cache line, the accessed line is cached in the shared state. This is referred to as the writethrough state because all write cycles to this cache line are driven externally on the bus.

If WB/WT# = 1 and PWT = 0 during a cacheable read miss or a write hit to a shared cache line, the accessed line is cached in the exclusive state. Subsequent write hits to the same line cause its state to transition from exclusive to modified. This is referred to as the writeback state because the data cache can contain modified cache lines that are subject to be written back—referred as a writeback cycle—as the result of an inquire cycle, an internal snoop, a flush operation, or the WBINVD instruction.

Sampled

WB/WT# is sampled on the clock edge that the first BRDY# or NA# of a bus cycle is sampled asserted. If the cycle is a burst read, WB/WT# is ignored during the last three assertions of BRDY#. WB/WT# is sampled during memory read and non-writeback write cycles and is ignored during all other types of cycles.

Table 14. Input Pin Types

Name	Type	Note	Name	Type	Note
A20M#	Asynchronous	Note 1	IGNNE#	Asynchronous	Note 1
AHOLD	Synchronous		INIT	Asynchronous	Note 2
BF[2:0]	Synchronous	Note 4	INTR	Asynchronous	Note 1
BOFF#	Synchronous		INV	Synchronous	
BRDY#	Synchronous		KEN#	Synchronous	
BRDYC#	Synchronous	Note 7	NA#	Synchronous	
CLK	Clock		NMI	Asynchronous	Note 2
EADS#	Synchronous		RESET	Asynchronous	Note 5, 6
EWBE#	Synchronous		SMI#	Asynchronous	Note 2
FLUSH#	Asynchronous	Note 2, 3	STPCLK#	Asynchronous	Note 1
HOLD	Synchronous		WB/WT#	Synchronous	

Notes:

1. These level-sensitive signals can be asserted synchronously or asynchronously. To be sampled on a specific clock edge, setup and hold times must be met. If asserted asynchronously, they must be asserted for a minimum pulse width of two clocks.
2. These edge-sensitive signals can be asserted synchronously or asynchronously. To be sampled on a specific clock edge, setup and hold times must be met. If asserted asynchronously, they must have been negated at least two clocks prior to assertion and must remain asserted at least two clocks.
3. FLUSH# is also sampled during the falling transition of RESET and can be asserted synchronously or asynchronously. To be sampled on a specific clock edge, setup and hold times must be met the clock edge before the clock edge on which RESET is sampled negated. If asserted asynchronously, FLUSH# must meet a minimum setup and hold time of two clocks relative to the negation of RESET.
4. BF[2:0] are sampled during the falling transition of RESET. They must meet a minimum setup time of 1.0 ms and a minimum hold time of two clocks relative to the negation of RESET.
5. During the initial power-on reset of the processor, RESET must remain asserted for a minimum of 1.0 ms after CLK and V_{CC} reach specification before it is negated.
6. During a warm reset, while CLK and V_{CC} are within their specification, RESET must remain asserted for a minimum of 15 clocks prior to its negation.
7. BRDYC# is also sampled during the falling transition of RESET. If RESET is driven synchronously, BRDYC# must meet the specified hold time relative to the negation of RESET. If asserted asynchronously, BRDYC# must meet a minimum setup and hold time of two clocks relative to the negation of RESET.

Table 15. Output Pin Float Conditions

Name	Floated At: (Note 1)	Note	Name	Floated At: (Note 1)	Note
A[4:3]	HLDA, AHOLD, BOFF#	Note 2, 3	HITM#	Always Driven	
ADS#	HLDA, BOFF#	Note 2	HLDA	Always Driven	
ADSC#	HLDA, BOFF#	Note 2	LOCK#	HLDA, BOFF#	Note 2
APCHK#	Always Driven		M/IO#	HLDA, BOFF#	Note 2
BE[7:0]#	HLDA, BOFF#	Note 2	PCD	HLDA, BOFF#	Note 2
BREQ	Always Driven		PCHK#	Always Driven	
CACHE#	HLDA, BOFF#	Note 2	PWT	HLDA, BOFF#	Note 2
D/C#	HLDA, BOFF#	Note 2	SCYC	HLDA, BOFF#	Note 2
FERR#	Always Driven		SMIACK#	Always Driven	
HIT#	Always Driven		W/R#	HLDA, BOFF#	Note 2

Notes:

1. All outputs except VCC2DET and TDO float during Tri-State Test mode.
2. Floated off the clock edge that BOFF# is sampled asserted and off the clock edge that HLDA is asserted.
3. Floated off the clock edge that AHOLD is sampled asserted.

Table 16. Input/Output Pin Float Conditions

Name	Floated At: (Note 1)	Note
A[31:5]	HLDA, AHOLD, BOFF#	Note 2,3
AP	HLDA, AHOLD, BOFF#	Note 2,3
D[63:0]	HLDA, BOFF#	Note 2
DP[7:0]	HLDA, BOFF#	Note 2

Notes:

1. All outputs except VCC2DET and TDO float during Tri-State Test mode.
2. Floated off the clock edge that BOFF# is sampled asserted and off the clock edge that HLDA is asserted.
3. Floated off the clock edge that AHOLD is sampled asserted.

Table 17. Test Pins

Name	Type	Note
TCK	Clock	
TDI	Input	Sampled on the rising edge of TCK
TDO	Output	Driven on the falling edge of TCK
TMS	Input	Sampled on the rising edge of TCK
TRST#	Input	Asynchronous (Independent of TCK)

Table 18. Bus Cycle Definition

Bus Cycle Initiated	Generated by Processor				Generated by System
	M/IO#	D/C#	W/R#	CACHE#	KEN#
Code Read, Instruction Cache Line Fill	1	0	0	0	0
Code Read, Noncacheable	1	0	0	1	x
Code Read, Noncacheable	1	0	0	x	1
Encoding for Special Cycle	0	0	1	1	x
Interrupt Acknowledge	0	0	0	1	x
I/O Read	0	1	0	1	x
I/O Write	0	1	1	1	x
Memory Read, Data Cache Line Fill	1	1	0	0	0
Memory Read, Noncacheable	1	1	0	1	x
Memory Read, Noncacheable	1	1	0	x	1
Memory Write, Data Cache Writeback	1	1	1	0	x
Memory Write, Noncacheable	1	1	1	1	x

Note:
x means "don't care"

Table 19. Special Cycles

Special Cycle	A4	BE7#	BE6#	BE5#	BE4#	BE3#	BE2#	BE1#	BE0#	M/IO#	D/C#	W/R#	CACHE#	KEN#
Stop Grant	1	1	1	1	1	1	0	1	1	0	0	1	1	x
Flush Acknowledge (FLUSH# sampled asserted)	0	1	1	1	0	1	1	1	1	0	0	1	1	x
Writeback (WBINVD instruction)	0	1	1	1	1	0	1	1	1	0	0	1	1	x
Halt	0	1	1	1	1	1	0	1	1	0	0	1	1	x
Flush (INVD, WBINVD instruction)	0	1	1	1	1	1	1	0	1	0	0	1	1	x
Shutdown	0	1	1	1	1	1	1	1	0	0	0	1	1	x

Note:
x means "don't care"

6 Bus Cycles

The following sections describe and illustrate the timing and relationship of bus signals during various types of bus cycles. A representative set of bus cycles is illustrated.

6.1 Timing Diagrams

The timing diagrams illustrate the signals on the external local bus as a function of time, as measured by the bus clock (CLK). Throughout this chapter, the term *clock* refers to a signal bus-clock cycle. A clock extends from one rising CLK edge to the next rising CLK edge. The processor samples and drives most signals relative to the rising edge of CLK. The exceptions to this rule include the following:

- BF[2:0]—Sampled on the falling edge of RESET
- FLUSH#, BRDYC#—Sampled on the falling edge of RESET, also sampled on the rising edge of CLK
- All inputs and outputs are sampled relative to TCK in Boundary-Scan Test Mode. Inputs are sampled on the rising edge of TCK, outputs are driven off of the falling edge of TCK.

For each signal in the timing diagrams, the High level represents 1, the Low level represents 0, and the Middle level represents the floating (high-impedance) state. When both the High and Low levels are shown, the meaning depends on the signal. A single signal indicates ‘don’t care’. In the case of bus activity, if both High and Low levels are shown, it indicates the processor, alternate master, or system logic is driving a value, but this value may or may not be valid. (For example, the value on the address bus is valid only during the assertion of ADS#, but addresses are also driven on the bus at other times.) Figure 43 on page 122 defines the different waveform representations.







Waveform	Description
	Don't care or bus is driven
	Signal or bus is changing from Low to High
	Signal or bus is changing from High to Low
	Bus is changing
	Bus is changing from valid to invalid
	Signal or bus is floating
	Denotes multiple clock periods

Figure 43. Waveform Definitions

For all active-High signals, the term *asserted* means the signal is in the High-voltage state and the term *negated* means the signal is in the Low-voltage state. For all active-Low signals, the term *asserted* means the signal is in the Low-voltage state and the term *negated* means the signal is in the High-voltage state.

6.2 Bus State Machine Diagram

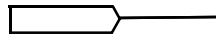

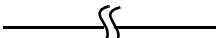
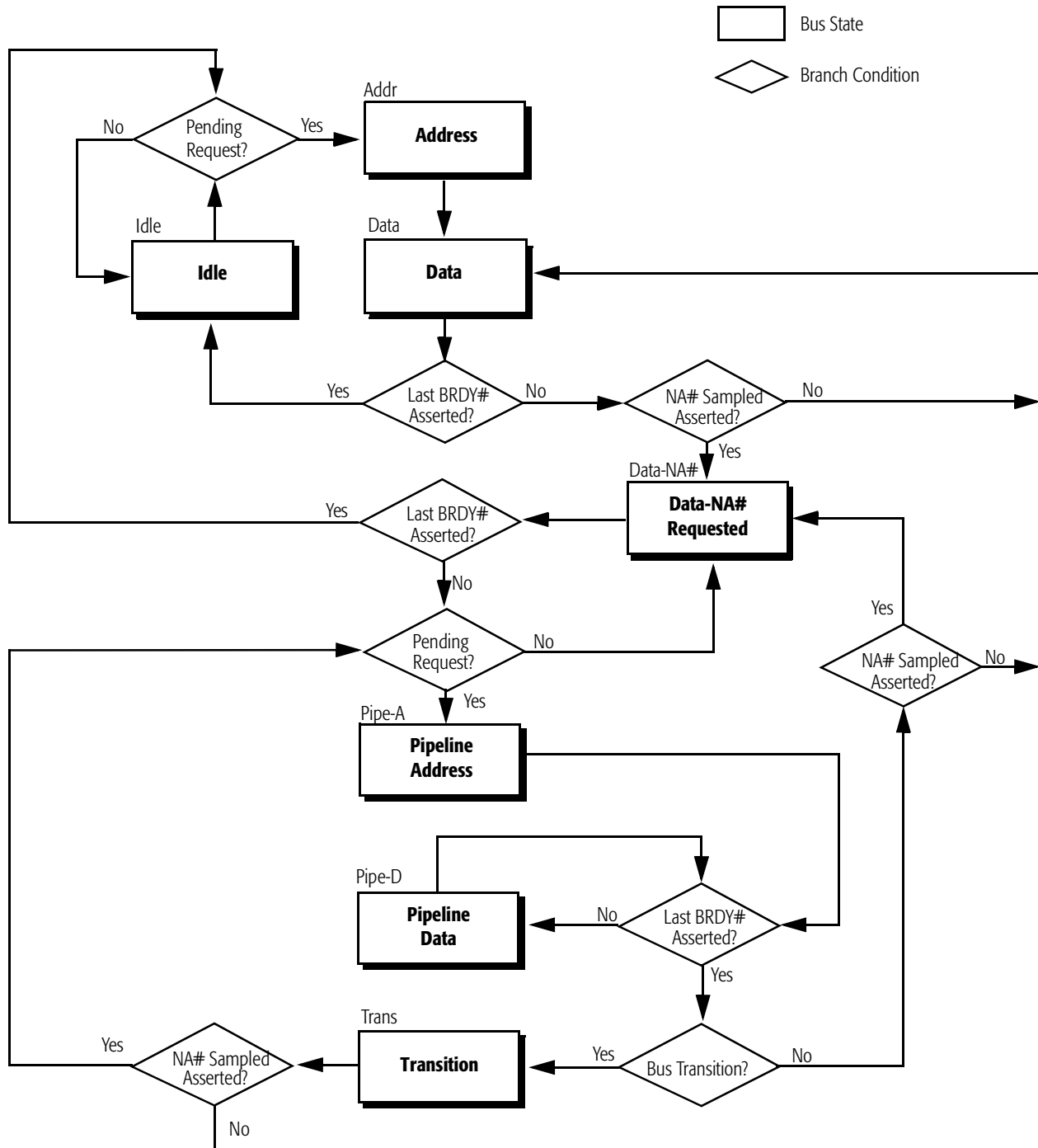
Note: The processor transitions to the IDLE state on the clock edge on which BOFF# or RESET is sampled asserted.

Figure 44. Bus State Machine Diagram

Idle

The processor does not drive the system bus in the Idle state and remains in this state until a new bus cycle is requested. The processor enters this state off the clock edge on which the last BRDY# of a cycle is sampled asserted during the following conditions:

- The processor is in the Data state
- The processor is in the Data-NA# Requested state and no internal pending cycle is requested

In addition, the processor is forced into this state when the system logic asserts RESET or BOFF#. The transition to this state occurs on the clock edge on which RESET or BOFF# is sampled asserted.

Address

In this state, the processor drives ADS# to indicate the beginning of a new bus cycle by validating the address and control signals. The processor remains in this state for one clock and unconditionally enters the Data state on the next clock edge.

Data

In the Data state, the processor drives the data bus during a write cycle or expects data to be returned during a read cycle. The processor remains in this state until either NA# or the last BRDY# is sampled asserted. If the last BRDY# is sampled asserted or both the last BRDY# and NA# are sampled asserted on the same clock edge, the processor enters the Idle state. If NA# is sampled asserted first, the processor enters the Data-NA# Requested state.

Data-NA# Requested

If the processor samples NA# asserted while in the Data state and the current bus cycle is not completed (the last BRDY# is not sampled asserted), it enters the Data-NA# Requested state. The processor remains in this state until either the last BRDY# is sampled asserted or an internal pending cycle is requested. If the last BRDY# is sampled asserted before the processor drives a new bus cycle, the processor enters the Idle state (no internal pending cycle is requested) or the Address state (processor has a internal pending cycle).

Pipeline Address

In this state, the processor drives ADS# to indicate the beginning of a new bus cycle by validating the address and control signals. In this state, the processor is still waiting for the current bus cycle to be completed (until the last BRDY# is

sampled asserted). If the last BRDY# is not sampled asserted, the processor enters the Pipeline Data state.

If the processor samples the last BRDY# asserted in this state, it determines if a bus transition is required between the current bus cycle and the pipelined bus cycle. A bus transition is required when the data bus direction changes between bus cycles, such as a memory write cycle followed by a memory read cycle. If a bus transition is required, the processor enters the Transition state for one clock to prevent data bus contention. If a bus transition is not required, the processor enters the Data state.

The processor does not transition to the Data-NA# Requested state from the Pipeline Address state because the processor does not begin sampling NA# until it has exited the Pipeline Address state.

Pipeline Data

Two bus cycles are concurrently executing in this state. The processor cannot issue any additional bus cycles until the current bus cycle is completed. The processor drives the data bus during write cycles or expects data to be returned during read cycles for the current bus cycle until the last BRDY# of the current bus cycle is sampled asserted.

If the processor samples the last BRDY# asserted in this state, it determines if a bus transition is required between the current bus cycle and the pipelined bus cycle. If the bus transition is required, the processor enters the Transition state for one clock to prevent data bus contention. If a bus transition is not required, the processor enters the Data state (NA# was not sampled asserted) or the Data-NA# Requested state (NA# was sampled asserted).

Transition

The processor enters this state for one clock during data bus transitions and enters the Data state on the next clock edge if NA# is not sampled asserted. The sole purpose of this state is to avoid bus contention caused by bus transitions during pipeline operation.

6.3 Memory Reads and Writes

The AMD-K6 processor performs single or burst memory bus cycles. The single-transfer memory bus cycle transfers 1, 2, 4, or 8 bytes and requires a minimum of two clocks. Misaligned instructions or operands result in a split cycle, which requires multiple transactions on the bus. A burst cycle consists of four back-to-back 8-byte (64-bit) transfers on the data bus.

Single-Transfer Memory Read and Write

Figure 45 on page 127 shows a single-transfer read from memory, followed by two single-transfer writes to memory. For the memory read cycle, the processor asserts ADS# for one clock to validate the bus cycle and also drives A[31:3], BE[7:0]#, D/C#, W/R#, and M/IO# to the bus. The processor then waits for the system logic to return the data on D[63:0] (with DP[7:0] for parity checking) and assert BRDY#. The processor samples BRDY# on every clock edge starting with the clock edge after the clock edge that negates ADS#. See “BRDY# (Burst Ready)” on page 88.

During the read cycle, the processor drives PCD, PWT, and CACHE# to indicate its caching and cache-coherency intent for the access. The system logic returns KEN# and WB/WT# to either confirm or change this intent. If the processor asserts PCD and negates CACHE#, the accesses are non-cacheable, even though the system logic asserts KEN# during the BRDY# to indicate its support for cacheability. The processor (which drives CACHE#) and the system logic (which drives KEN#) must agree in order for an access to be cacheable.

The processor can drive another cycle (in this example, a write cycle) by asserting ADS# off the next clock edge after BRDY# is sampled asserted. Therefore, an idle clock is guaranteed between any two bus cycles. The processor drives D[63:0] with valid data one clock edge after the clock edge on which ADS# is asserted. To minimize CPU idle times, the system logic stores the address and data in write buffers, returns BRDY#, and performs the store to memory later. If the processor samples EWBE# negated during a write cycle, it suspends certain activities until EWBE# is sampled asserted. See “EWBE# (External Write Buffer Empty)” on page 95. In Figure 45, the second write cycle occurs during the execution of a serializing instruction. The processor delays the following cycle until EWBE# is sampled asserted.

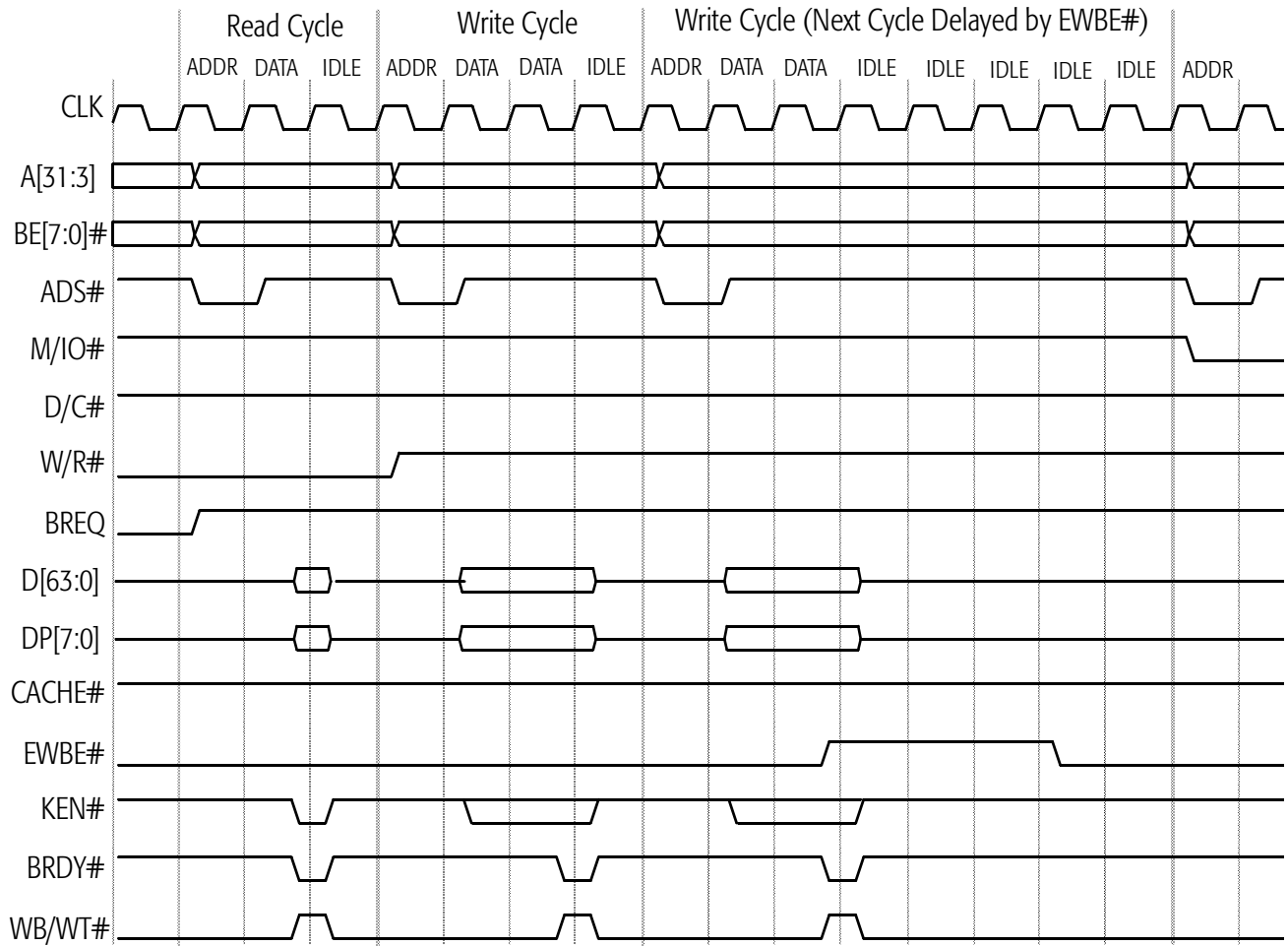

Figure 45. Non-Pipelined Single-Transfer Memory Read/Write and Write Delayed by EWBE#

Misaligned Single-Transfer Memory Read and Write

Figure 46 on page 129 shows a misaligned (split) memory read followed by a misaligned memory write. Any cycle that is not aligned as defined in “SCYC (Split Cycle)” on page 111 is considered misaligned. When the processor encounters a misaligned access, it determines the appropriate pair of bus cycles—each with its own ADS# and BRDY#—required to complete the access.

The AMD-K6 processor performs misaligned memory reads and memory writes using least-significant bytes (LSBs) first followed by most-significant bytes (MSBs). Table 20 shows the order. In the first memory read cycle in Figure 46, the processor reads the least-significant bytes. Immediately after the processor samples BRDY# asserted, it drives the second bus cycle to read the most-significant bytes to complete the misaligned transfer.

Table 20. Bus-Cycle Order During Misaligned Transfers

Type of Access	First Cycle	Second Cycle
Memory Read	LSBs	MSBs
Memory Write	LSBs	MSBs

Similarly, the misaligned memory write cycle in Figure 46 transfers the LSBs to the memory bus first. In the next cycle, after the processor samples BRDY# asserted, the MSBs are written to the memory bus.

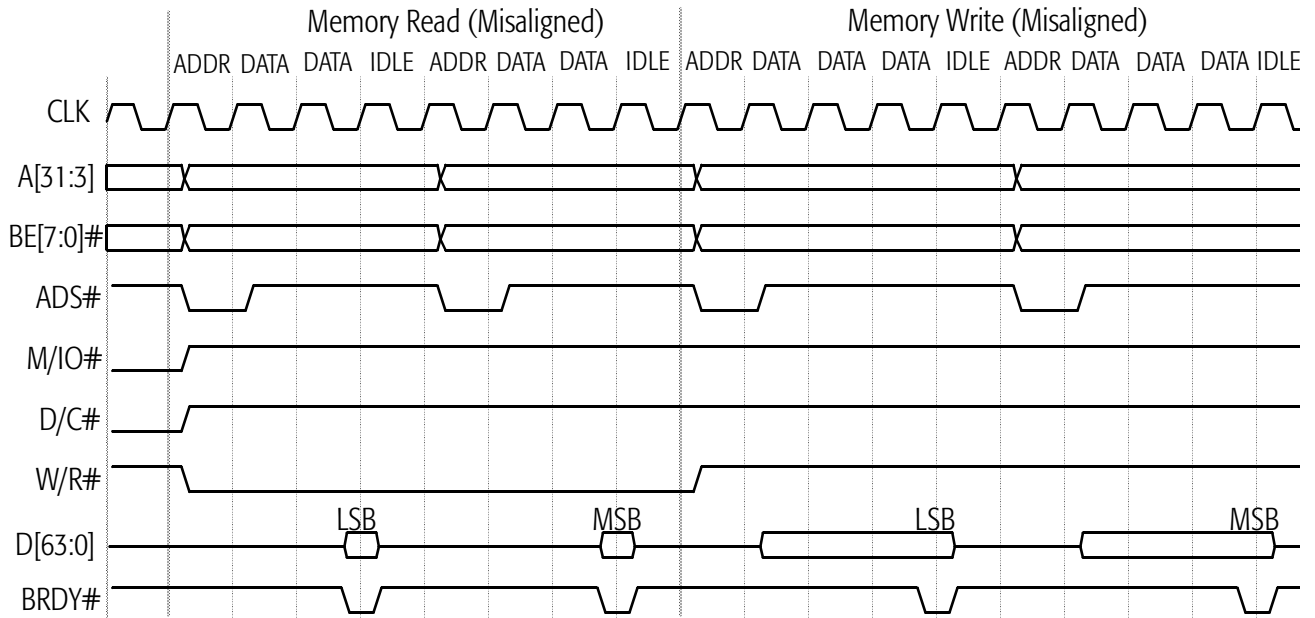

Figure 46. Misaligned Single-Transfer Memory Read and Write

Burst Reads and Pipelined Burst Reads

Figure 47 on page 131 shows normal burst read cycles and a pipelined burst read cycle. The AMD-K6 processor drives CACHE# and ADS# together to specify that the current bus cycle is a burst cycle. If the processor samples KEN# asserted with the first BRDY#, it performs burst transfers. During the burst transfers, the system logic must ignore BE[7:0]# and must return all eight bytes beginning at the starting address the processor asserts on A[31:3]. Depending on the starting address, the system logic must determine the successive quadword addresses (A[4:3]) for each transfer in a burst, as shown in Table 21. The processor expects the second, third, and fourth quadwords to occur in the sequences shown in Table 21.

Table 21. A[4:3] Address-Generation Sequence During Bursts

Address Driven By Processor on A[4:3]	A[4:3] Addresses of Subsequent Quadwords* Generated By System Logic		
	Quadword 2	Quadword 3	Quadword 4
Quadword 1			
00b	01b	10b	11b
01b	00b	11b	10b
10b	11b	00b	01b
11b	10b	01b	00b

Note:
* quadword = 8 bytes

In Figure 47, the processor drives CACHE# throughout all burst read cycles. In the first burst read cycle, the processor drives ADS# and CACHE#, then samples BRDY# on every clock edge starting with the clock edge after the clock edge that negates ADS#. The processor samples KEN# asserted on the clock edge on which the first BRDY# is sampled asserted, executes a 32-byte burst read cycle, and expects to sample BRDY# a total of four times. An ideal no-wait state access is shown in Figure 47, whereas most system logic solutions add wait states between the transfers.

The second burst read cycle illustrates a similar sequence, but the processor samples NA# asserted on the same clock edge that the first BRDY# is sampled asserted. NA# assertion indicates the system logic is requesting the processor to output the next address early (also known as a pipeline transfer request). Without waiting for the current cycle to complete, the processor drives ADS# and related signals for the next burst cycle. Pipelining can reduce CPU cycle-to-cycle idle times.

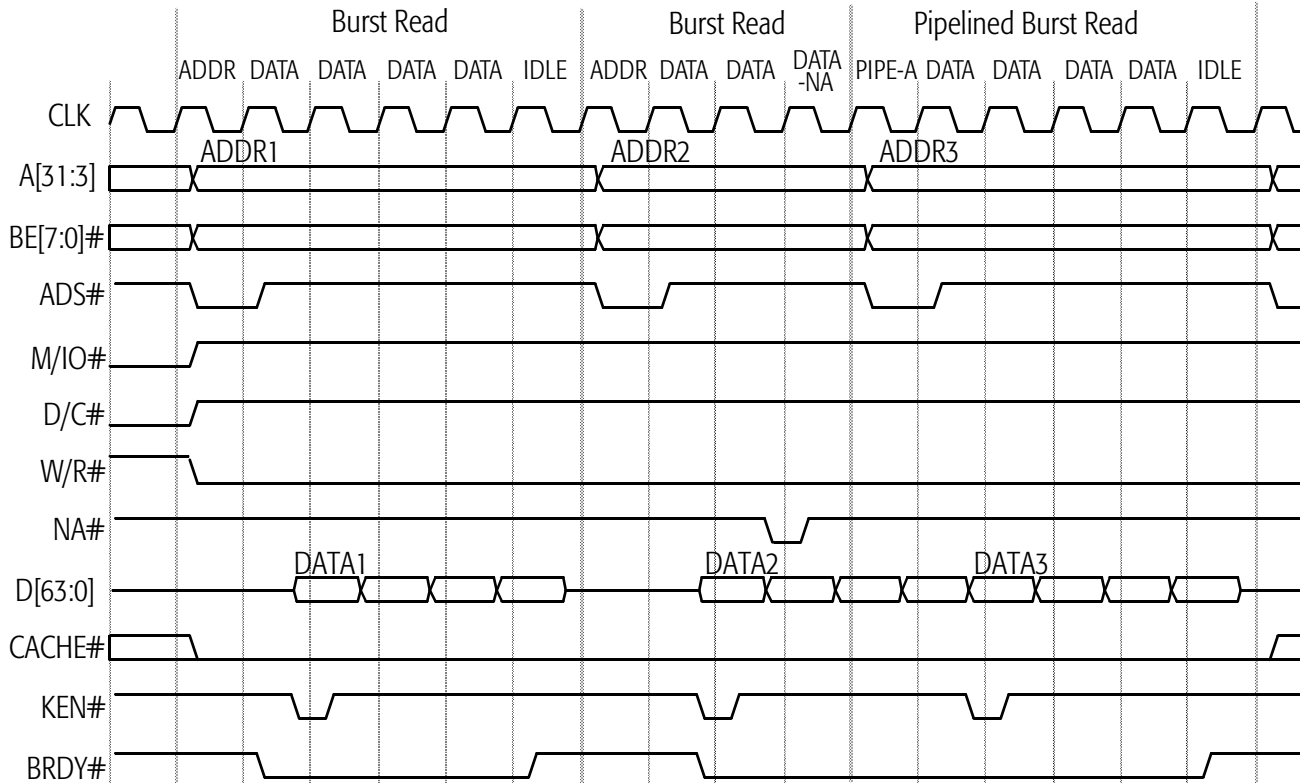

Figure 47. Burst Reads and Pipelined Burst Reads

Burst Writeback

Figure 48 on page 133 shows a burst read followed by a writeback transaction. The AMD-K6 processor initiates writebacks under the following conditions:

- *Replacement*—If a cache-line fill is initiated for a cache line currently filled with valid entries, the processor uses a least-recently-allocated (LRA) algorithm to select a line for replacement. Before a replacement is made to a data cache line that is in the modified state, the modified line is scheduled to be written back to memory.
- *Internal Snoop*—The processor snoops the data cache whenever an instruction-cache line is read, and it snoops the instruction cache whenever a data cache line is written. This snooping is performed to determine whether the same address is stored in both caches, a situation that is taken to imply the occurrence of self-modifying code. If a snoop hits a data cache line in the modified state, the line is written back to memory before being invalidated.
- *WBINVD Instruction*—When the processor executes a WBINVD instruction, it writes back all modified lines in the data cache and then invalidates all lines in both caches.
- *Cache Flush*—When the processor samples FLUSH# asserted, it executes a flush acknowledge special cycle and writes back all modified lines in the data cache and then invalidates all lines in both caches.

The processor drives writeback cycles during inquire or cache flush cycles. The writeback shown in Figure 48 is caused by a cache-line replacement. The processor completes the burst read cycle that fills the cache line. Immediately following the burst read cycle is the burst writeback cycle that represents the modified line to be written back to memory. D[63:0] are driven one clock edge after the clock edge on which ADS# is asserted and are subsequently changed off the clock edge on which each BRDY# assertion of the burst cycle is sampled.

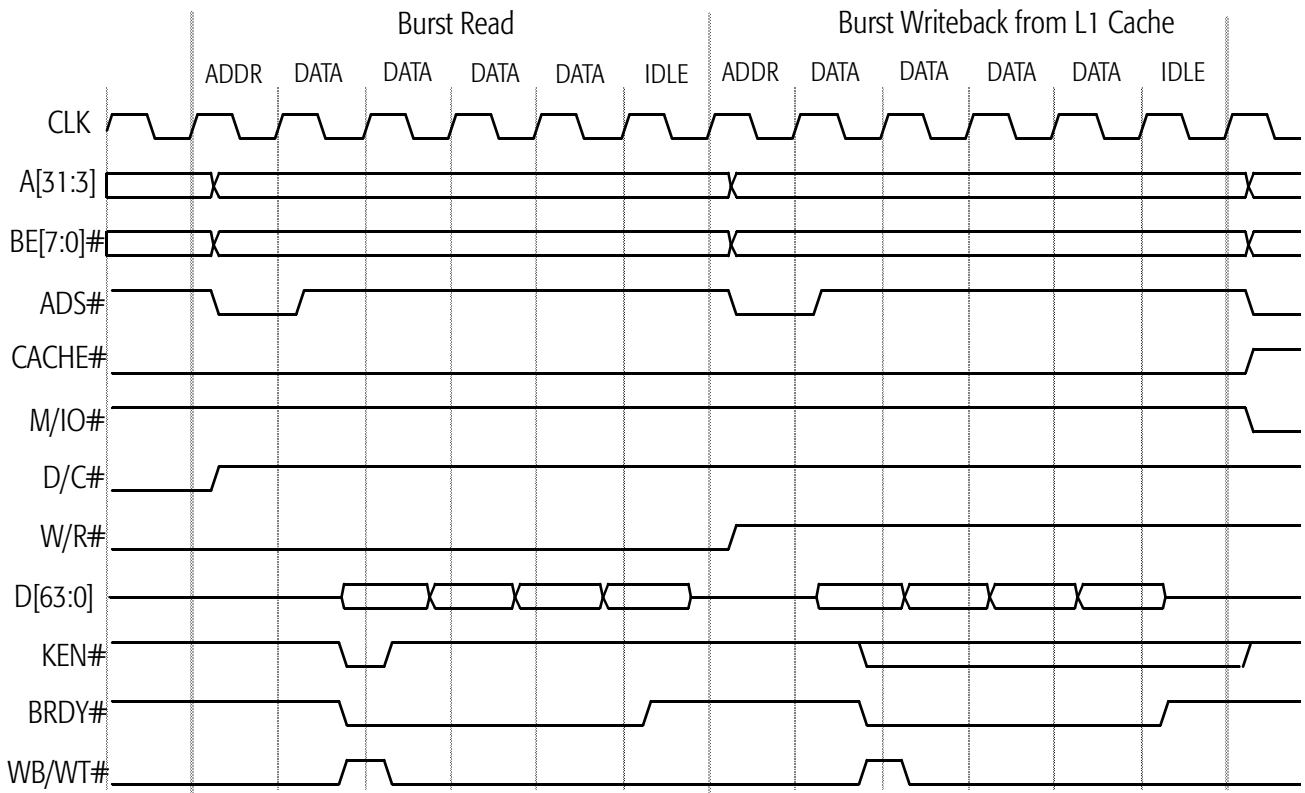

Figure 48. Burst Writeback due to Cache-Line Replacement

6.4 I/O Read and Write

Basic I/O Read and Write

The processor accesses I/O when it executes an I/O instruction (for example, IN or OUT). Figure 49 shows an I/O read followed by an I/O write. The processor drives M/IO# Low and D/C# High during I/O cycles. In this example, the first cycle shows a single wait state I/O read cycle. It follows the same sequence as a single-transfer memory read cycle. The processor drives ADS# to initiate the bus cycle, then it samples BRDY# on every clock edge starting with the clock edge after the clock edge that negates ADS#. The system logic must return BRDY# to complete the cycle. When the processor samples BRDY# asserted, it can assert ADS# for the next cycle off the next clock edge. (In this example, an I/O write cycle.)

The I/O write cycle is similar to a memory write cycle, but the processor drives M/IO# low during an I/O write cycle. The processor asserts ADS# to initiate the bus cycle. The processor drives D[63:0] with valid data one clock edge after the clock edge on which ADS# is asserted. The system logic must assert BRDY# when the data is properly stored to the I/O destination. The processor samples BRDY# on every clock edge starting with the clock edge after the clock edge that negates ADS#. In this example, two wait states are inserted while the processor waits for BRDY# to be asserted.

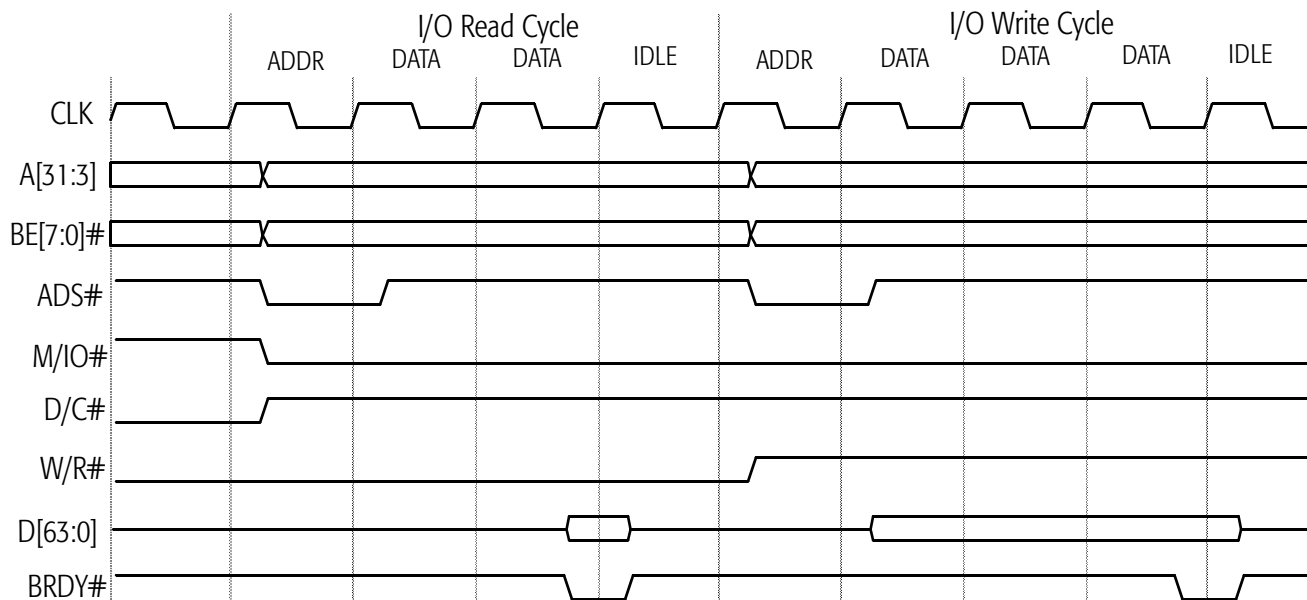

Figure 49. Basic I/O Read and Write

Misaligned I/O Read and Write

Table 22 shows the misaligned I/O read and write cycle order executed by the AMD-K6. In Figure 50, the least-significant bytes (LSBs) are transferred first. Immediately after the processor samples BRDY# asserted, it drives the second bus cycle to transfer the most-significant bytes (MSBs) to complete the misaligned bus cycle.

Table 22. Bus-Cycle Order During Misaligned I/O Transfers

Type of Access	First Cycle	Second Cycle
I/O Read	LSBs	MSBs
I/O Write	LSBs	MSBs

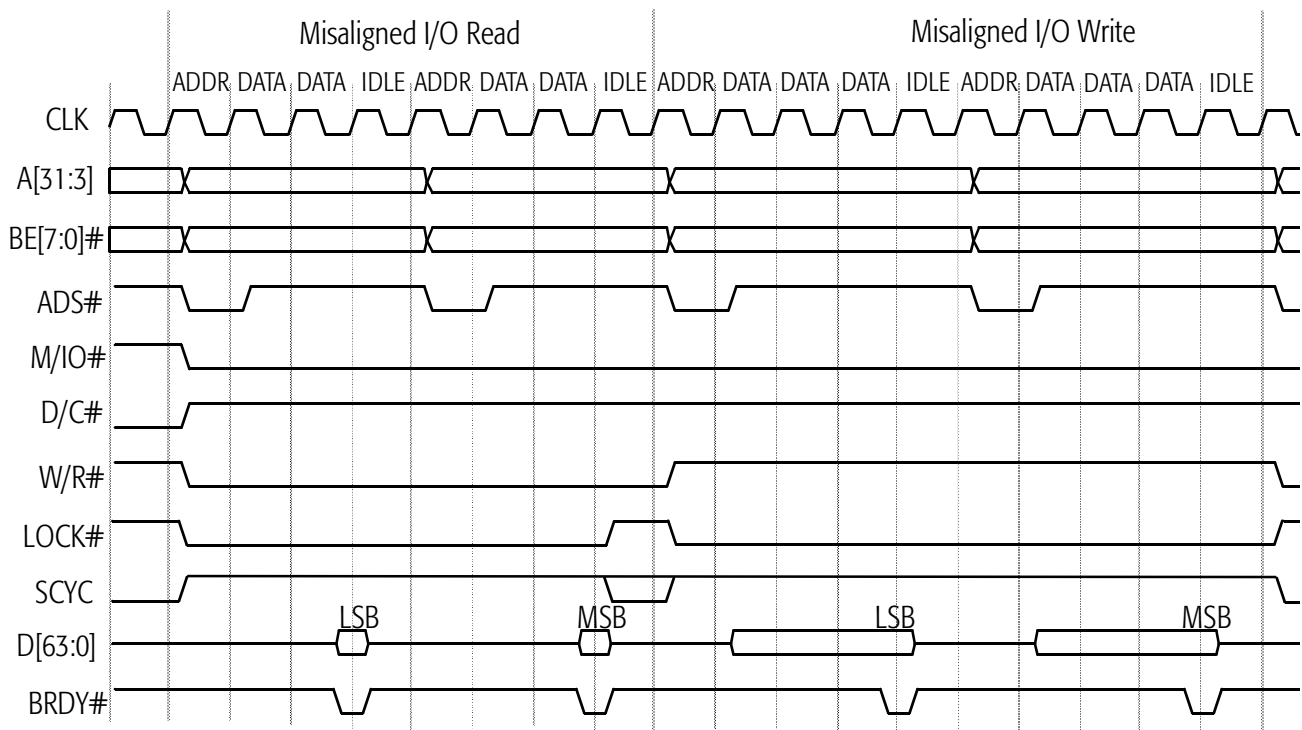

Figure 50. Misaligned I/O Transfer

6.5 Inquire and Bus Arbitration Cycles

The AMD-K6 processor provides built-in level-one data and instruction caches. Each cache is 32 Kbytes and two-way set-associative. The system logic or other bus master devices can initiate an inquire cycle to maintain cache/memory coherency. In response to the inquire cycle, the processor compares the inquire address with its cache tag addresses in both caches, and, if necessary, updates the MESI state of the cache line and performs writebacks to memory.

An inquire cycle can be initiated by asserting AHOLD, BOFF#, or HOLD. AHOLD is exclusively used to support inquire cycles. During AHOLD-initiated inquire cycles, the processor only floats the address bus. BOFF# provides the fastest access to the bus because it aborts any processor cycle that is in-progress, whereas AHOLD and HOLD both permit an in-progress bus cycle to complete. During HOLD-initiated and BOFF#-initiated inquire cycles, the processor floats all of its bus-driving signals.

Hold and Hold Acknowledge Cycle

The system logic or another bus device can assert HOLD to initiate an inquire cycle or to gain full control of the bus. When the AMD-K6 processor samples HOLD asserted, it completes any in-progress bus cycle and asserts HLDA to acknowledge release of the bus. The processor floats the following signals off the same clock edge that HLDA is asserted:

- | | |
|------------|-----------|
| ■ A[31:3] | ■ DP[7:0] |
| ■ ADS# | ■ LOCK# |
| ■ AP# | ■ M/IO# |
| ■ BE[7:0]# | ■ PCD |
| ■ CACHE# | ■ PWT |
| ■ D[63:0] | ■ SCYC |
| ■ D/C# | ■ W/R# |

Figure 51 on page 137 shows a basic HOLD/HLDA operation. In this example, the processor samples HOLD asserted during the memory read cycle. It continues the current memory read cycle until BRDY# is sampled asserted. The processor drives HLDA and floats its outputs one clock edge after the last BRDY# of the cycle is sampled asserted. The system logic can assert HOLD for as long as it needs to utilize the bus. The processor samples HOLD on every clock edge but does not assert HLDA until any in-progress cycle or sequence of locked cycles is completed.

When the processor samples HOLD negated during a hold acknowledge cycle, it negates HLDA off the next clock edge. The processor regains control of the bus and can assert ADS# off the same clock edge on which HLDA is negated.

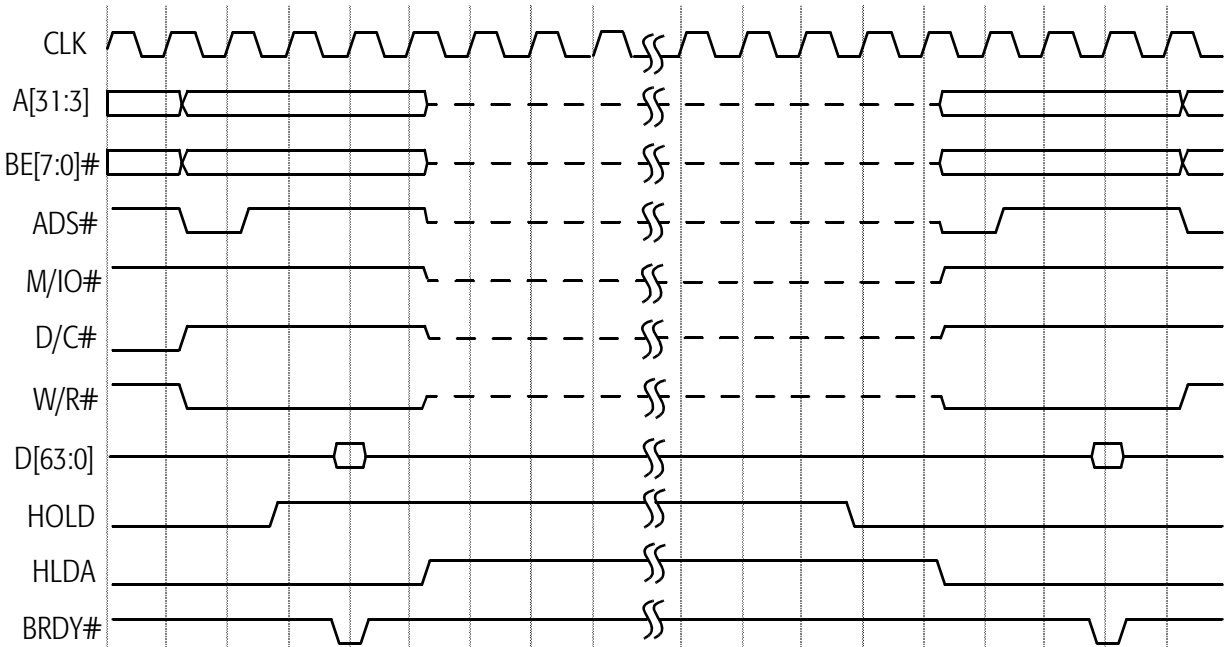

Figure 51. Basic HOLD/HLDA Operation

**HOLD-Initiated
Inquire Hit to Shared
or Exclusive Line**

Figure 52 on page 139 shows a HOLD-initiated inquire cycle. In this example, the processor samples HOLD asserted during the burst memory read cycle. The processor completes the current cycle (until the last expected BRDY# is sampled asserted), asserts HLDA and floats its outputs as described on page 136.

The system logic drives an inquire cycle within the hold acknowledge cycle. It asserts EADS#, which validates the inquire address on A[31:5]. If EADS# is sampled asserted before HOLD is sampled negated, the processor recognizes it as a valid inquire cycle.

In Figure 52, the processor asserts HIT# and negates HITM# on the clock edge after the clock edge on which EADS# is sampled asserted, indicating the current inquire cycle hit a shared or exclusive cache line. (Shared and exclusive cache lines in the processor data or instruction cache have the same contents as the data in the external memory.) During an inquire cycle, the processor samples INV to determine whether the addressed cache line found in the processor's instruction or data cache transitions to the invalid state or the shared state. In this example, the processor samples INV asserted with EADS#, which invalidates the cache line.

The system logic can negate HOLD off the same clock edge on which EADS# is sampled asserted. The processor continues driving HIT# in the same state until the next inquire cycle. HITM# is not asserted unless HIT# is asserted.

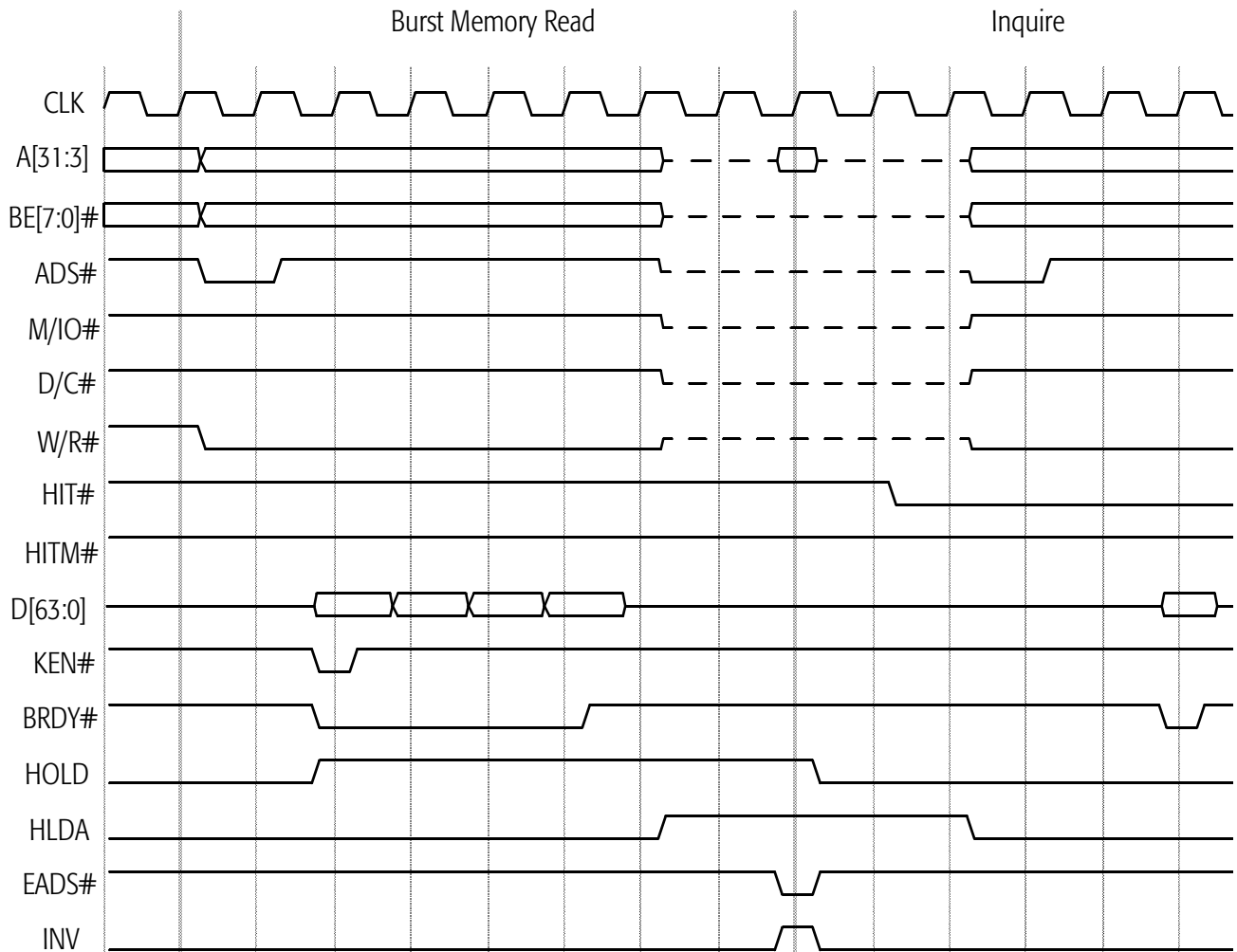

Figure 52. HOLD-Initiated Inquire Hit to Shared or Exclusive Line

**HOLD-Initiated
Inquire Hit to
Modified Line**

Figure 53 on page 141 shows the same sequence as Figure 52 on page 139, but in Figure 53 the inquire cycle hits a modified line and the processor asserts both HIT# and HITM#. In this example, the processor performs a writeback cycle immediately after the inquire cycle. It updates the modified cache line to the external memory (normally, level-two cache or DRAM). The processor uses the address (A[31:5]) that was latched during the inquire cycle to perform the writeback cycle. The processor asserts HITM# throughout the writeback cycle and negates HITM# one clock edge after the last expected BRDY# of the writeback is sampled asserted.

When the processor samples EADS# during the inquire cycle, it also samples INV to determine the cache line MESI state after the inquire cycle. If INV is sampled asserted during an inquire cycle, the processor transitions the line (if found) to the invalid state, regardless of its previous state. The cache line invalidation operation is not visible on the bus. If INV is sampled negated during an inquire cycle, the processor transitions the line (if found) to the shared state. In Figure 53 the processor samples INV asserted during the inquire cycle.

In a HOLD-initiated inquire cycle, the system logic can negate HOLD off the same clock edge on which EADS# is sampled asserted. The processor drives HIT# and HITM# on the clock edge after the clock edge on which EADS# is sampled asserted.

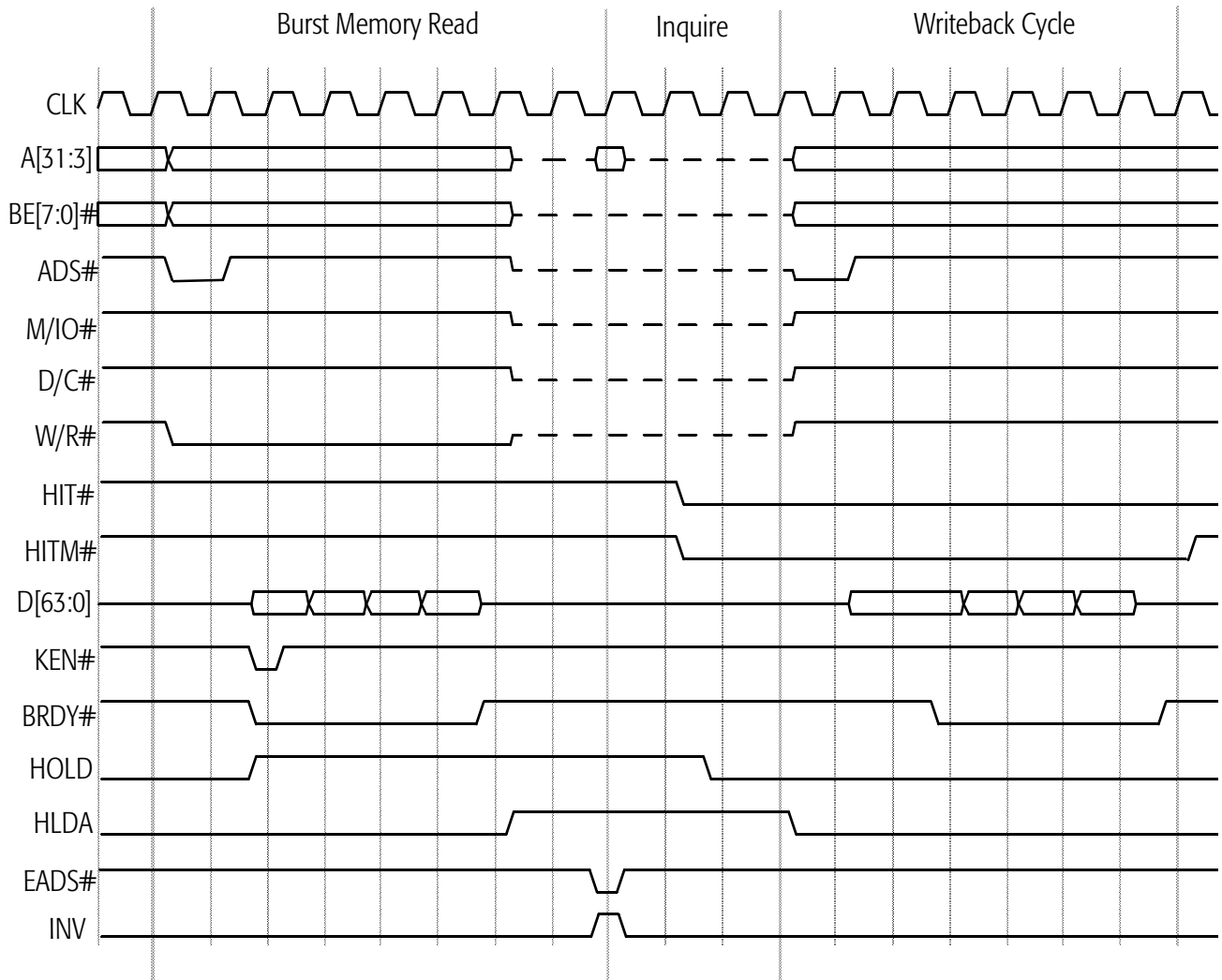

Figure 53. HOLD-Initiated Inquire Hit to Modified Line

**AHOLD-Initiated
Inquire Miss**

AHOLD can be asserted by the system to initiate one or more inquire cycles. To allow the system to drive the address bus during an inquire cycle, the processor floats A[31:3] and AP off the clock edge on which AHOLD is sampled asserted. The data bus and all other control and status signals remain under the control of the processor and are not floated. This functionality allows a bus cycle in progress when AHOLD is sampled asserted to continue to completion. The processor resumes driving the address bus off the clock edge on which AHOLD is sampled negated.

In Figure 54 on page 143, the processor samples AHOLD asserted during the memory burst read cycle, and it floats the address bus off the same clock edge on which it samples AHOLD asserted. While the processor still controls the bus, it completes the current cycle until the last expected BRDY# is sampled asserted. The system logic drives EADS# with an inquire address on A[31:5] during an inquire cycle. The processor samples EADS# asserted and compares the inquire address to its tag address in both the instruction and data caches. In Figure 54, the inquire address misses the tag address in the processor (both HIT# and HITM# are negated). Therefore, the processor proceeds to the next cycle when it samples AHOLD negated. (The processor can drive a new cycle by asserting ADS# off the same clock edge that it samples AHOLD negated.)

For an AHOLD-initiated inquire cycle to be recognized, the processor must sample AHOLD asserted for at least two consecutive clocks before it samples EADS# asserted. If the processor detects an address parity error during an inquire cycle, APCHK# is asserted for one clock. The system logic must respond appropriately to the assertion of this signal.

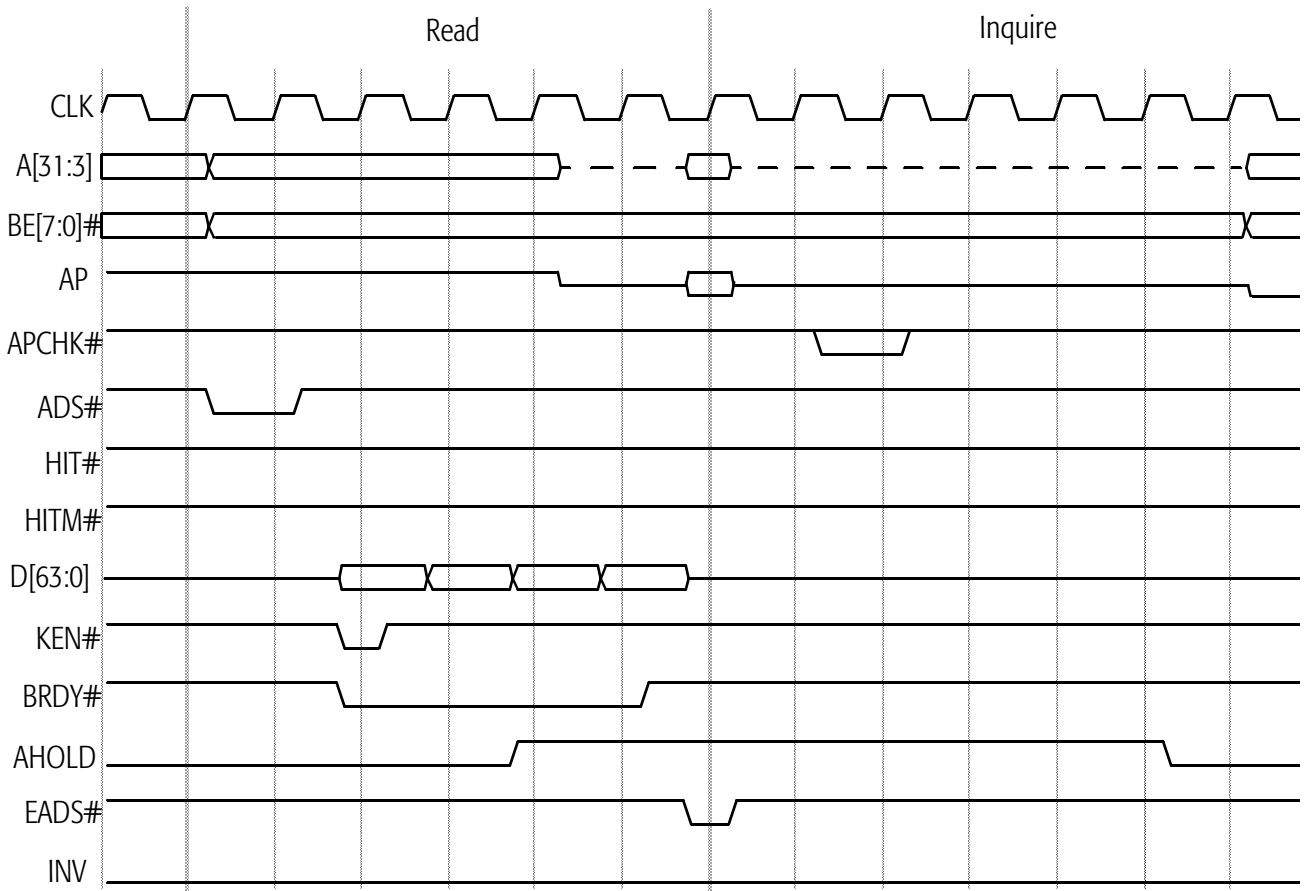

Figure 54. AHOLD-Initiated Inquire Miss

**AHOLD-Initiated
Inquire Hit to Shared
or Exclusive Line**

In Figure 55 on page 145, the processor asserts HIT# and negates HITM# off the clock edge after the clock edge on which EADS# is sampled asserted, indicating the current inquire cycle hits either a shared or exclusive line. (HIT# is driven in the same state until the next inquire cycle.) The processor samples INV asserted during the inquire cycle and transitions the line to the invalid state regardless of its previous state.

During an AHOLD-initiated inquire cycle, the processor samples AHOLD on every clock edge until it is negated. In Figure 55, the processor asserts ADS# off the same clock on which AHOLD is sampled negated. If the inquire cycle hits a modified line, the processor performs a writeback cycle before it drives a new bus cycle. The next section describes the AHOLD-initiated inquire cycle that hits a modified line.

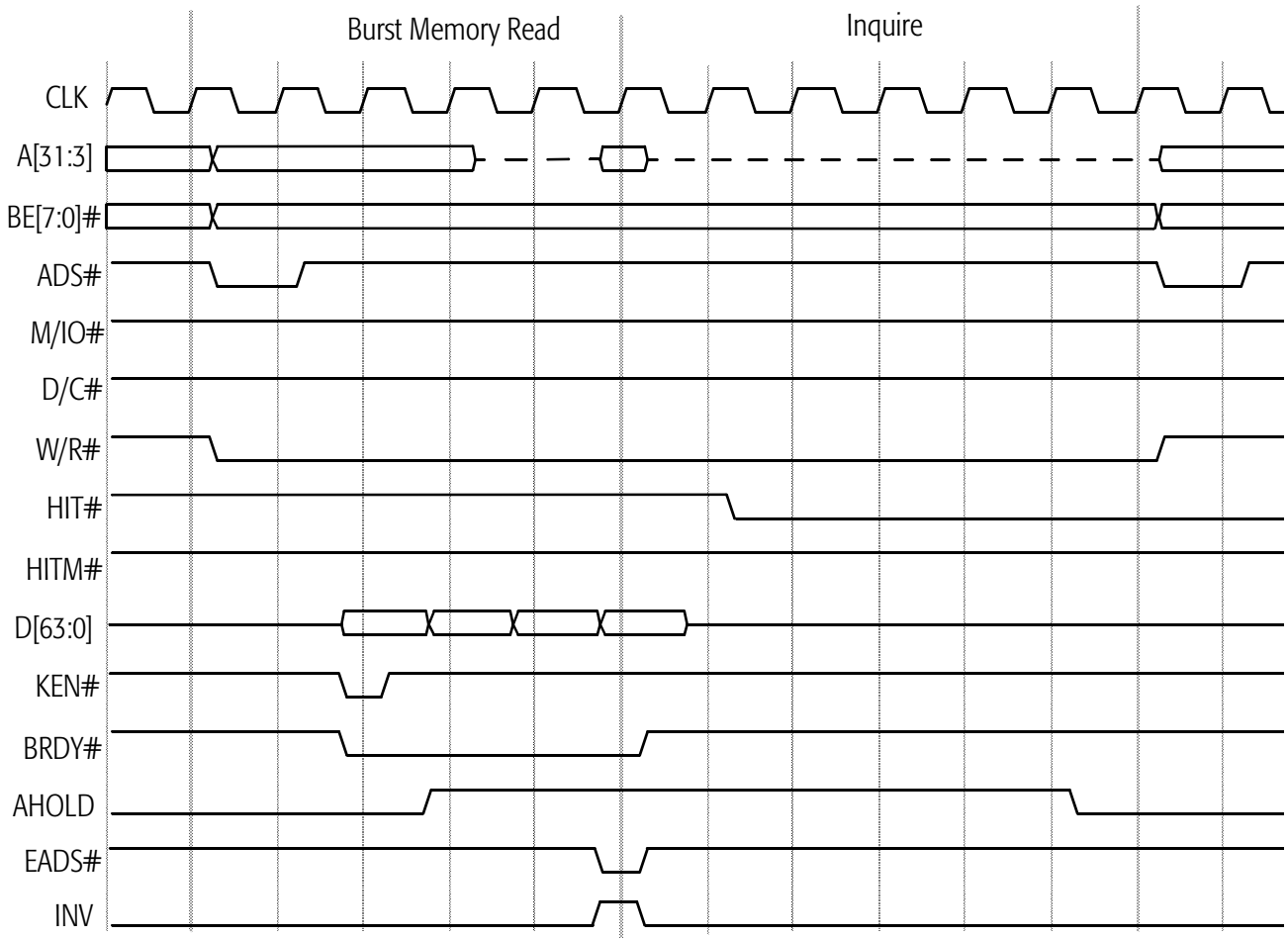

Figure 55. AHOLD-Initiated Inquire Hit to Shared or Exclusive Line

**AHOLD-Initiated
Inquire Hit to
Modified Line**

Figure 56 on page 147 shows an AHOLD-initiated inquire cycle that hits a modified line. During the inquire cycle in this example, the processor asserts both HIT# and HITM# on the clock edge after the clock edge that it samples EADS# asserted. This condition indicates that the cache line exists in the processor's data cache in the modified state.

If the inquire cycle hits a modified line, the processor performs a writeback cycle immediately after the inquire cycle to update the modified cache line to shared memory (normally level-two cache or DRAM). In Figure 56, the system logic holds AHOLD asserted throughout the inquire cycle and the processor writeback cycle. In this case, the processor is not driving the address bus during the writeback cycle because AHOLD is sampled asserted. The system logic writes the data to memory by using its latched copy of the inquire cycle address. If the processor samples AHOLD negated before it performs the writeback cycle, it drives the writeback cycle by using the address (A[31:5]) that it latched during the inquire cycle.

If INV is sampled asserted during an inquire cycle, the processor transitions the line (if found) to the invalid state, regardless of its previous state (the cache invalidation operation is not visible on the bus). If INV is sampled negated during an inquire cycle, the processor transitions the line (if found) to the shared state. In either case, if the line is found in the modified state, the processor writes it back to memory before changing its state. Figure 56 shows that the processor samples INV asserted during the inquire cycle and invalidates the cache line after the inquire cycle.

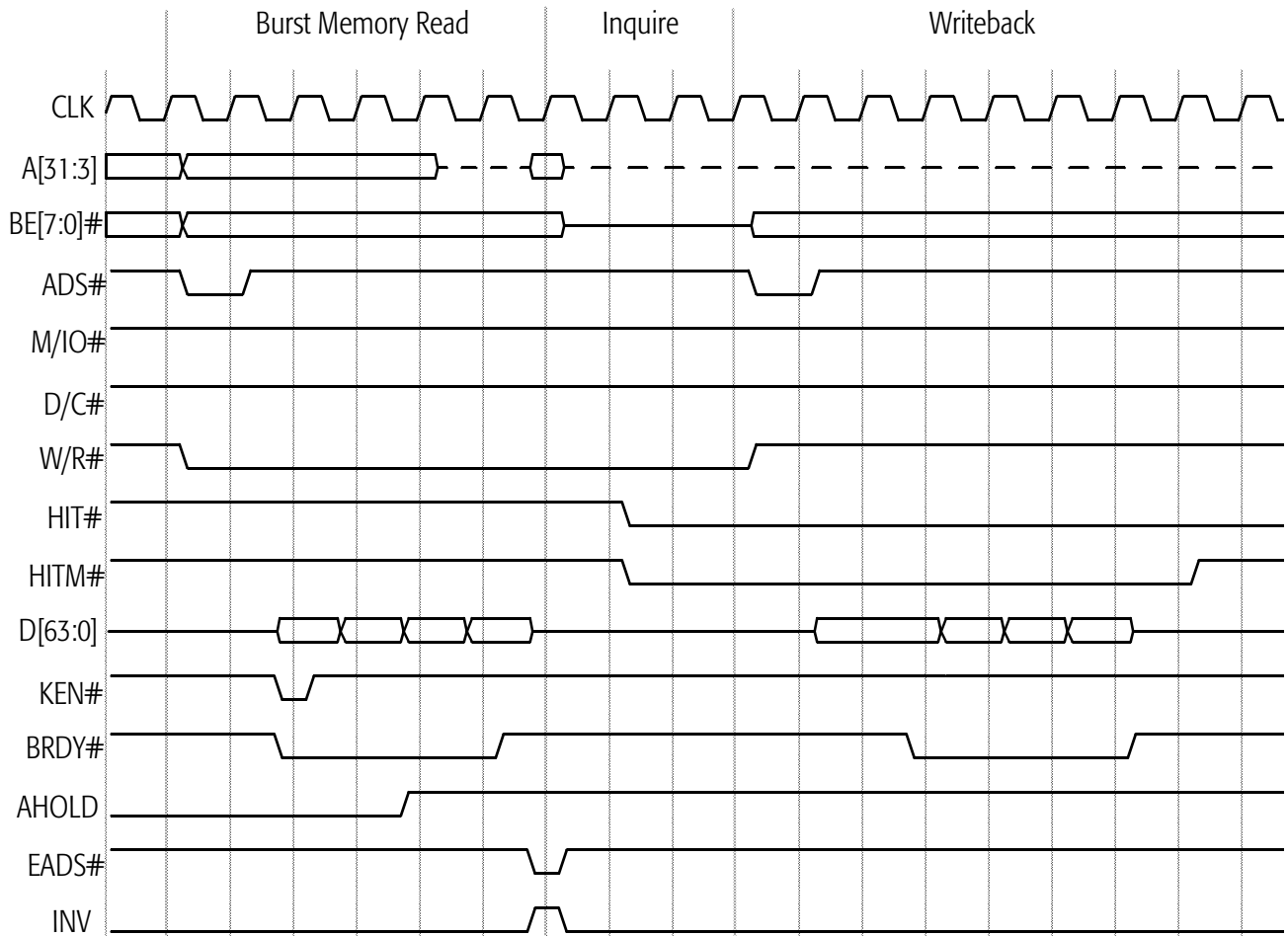

Figure 56. AHOLD-Initiated Inquire Hit to Modified Line

AHOLD Restriction

When the system logic drives an AHOLD-initiated inquire cycle, it must assert AHOLD for at least two clocks before it asserts EADS#. This requirement guarantees the processor recognizes and responds to the inquire cycle properly. The processor's 32 address bus drivers turn on almost immediately after AHOLD is sampled negated. If the processor switches the data bus (D[63:0] and DP[7:0]) during a write cycle off the same clock edge that switches the address bus (A[31:3] and AP), the processor switches 102 drivers simultaneously, which can lead to ground-bounce spikes. Therefore, before negating AHOLD the following restrictions must be observed by the system logic:

- When the system logic negates AHOLD during a write cycle, it must ensure that AHOLD is not sampled negated on the clock edge on which BRDY# is sampled asserted (See Figure 57 on page 149).
- When the system logic negates AHOLD during a writeback cycle, it must ensure that AHOLD is not sampled negated on the clock edge on which ADS# is negated (See Figure 57).
- When a write cycle is pipelined into a read cycle, AHOLD must not be sampled negated on the clock edge after the clock edge on which the last BRDY# of the read cycle is sampled asserted to avoid the processor simultaneously driving the data bus (for the pending write cycle) and the address bus off this same clock edge.

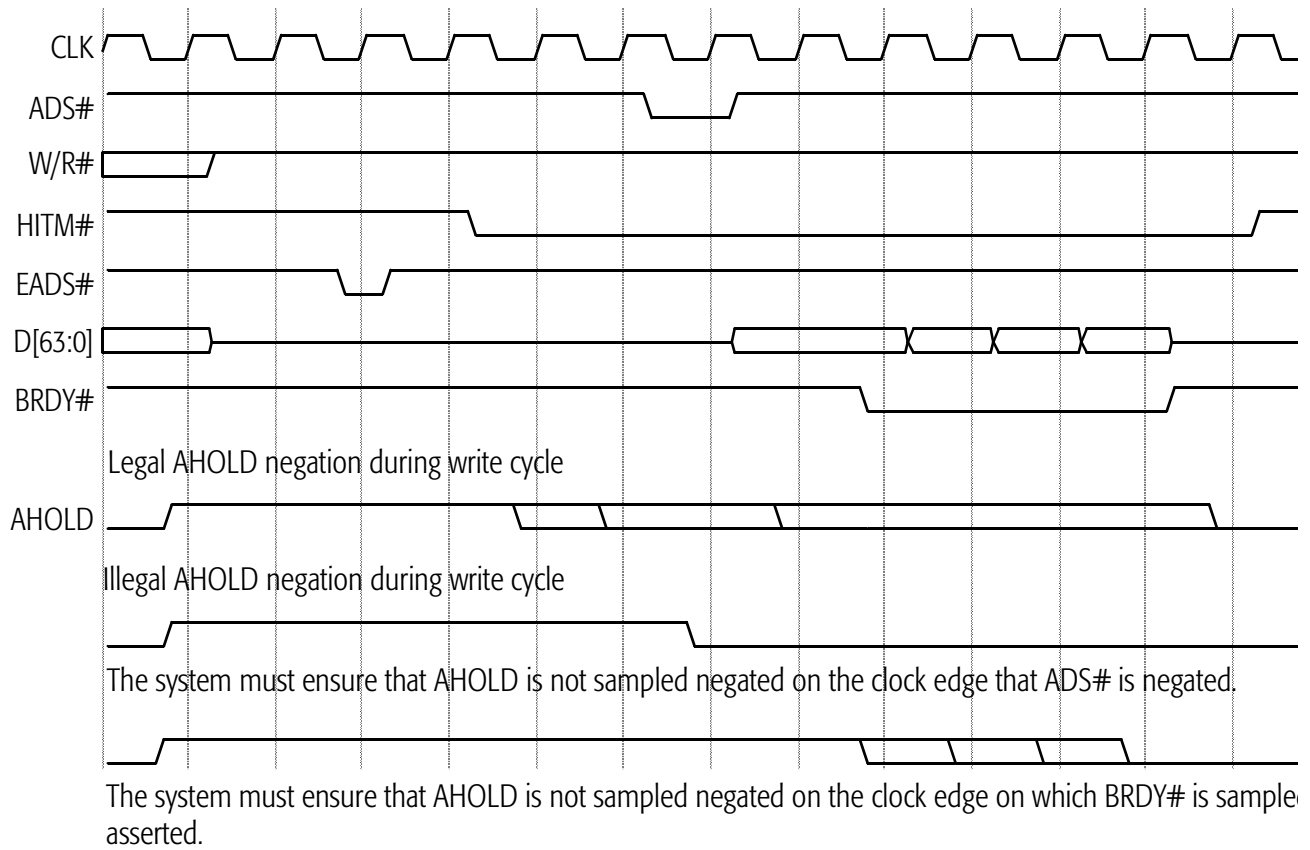

Figure 57. AHOLD Restriction

Bus Backoff (BOFF#)

BOFF# provides the fastest response among bus-hold inputs. Either the system logic or another bus master can assert BOFF# to gain control of the bus immediately. BOFF# is also used to resolve potential deadlock problems that arise as a result of inquire cycles. The processor samples BOFF# on every clock edge. If BOFF# is sampled asserted, the processor unconditionally aborts any cycles in progress and transitions to a bus hold state. (See “BOFF# (Backoff)” on page 87.) Figure 58 on page 151 shows a read cycle that is aborted when the processor samples BOFF# asserted even though BRDY# is sampled asserted on the same clock edge. The read cycle is restarted after BOFF# is sampled negated (KEN# must be in the same state during the restarted cycle as its state during the aborted cycle).

During a BOFF#-initiated inquire cycle that hits a shared or exclusive line, the processor samples BOFF# negated and restarts any bus cycle that was aborted when BOFF# was asserted. If a BOFF#-initiated inquire cycle hits a modified line, the processor performs a writeback cycle before it restarts the aborted cycle.

If the processor samples BOFF# asserted on the same clock edge that it asserts ADS#, ADS# is floated but the system logic may erroneously interpret ADS# as asserted. In this case, the system logic must properly interpret the state of ADS# when BOFF# is negated.

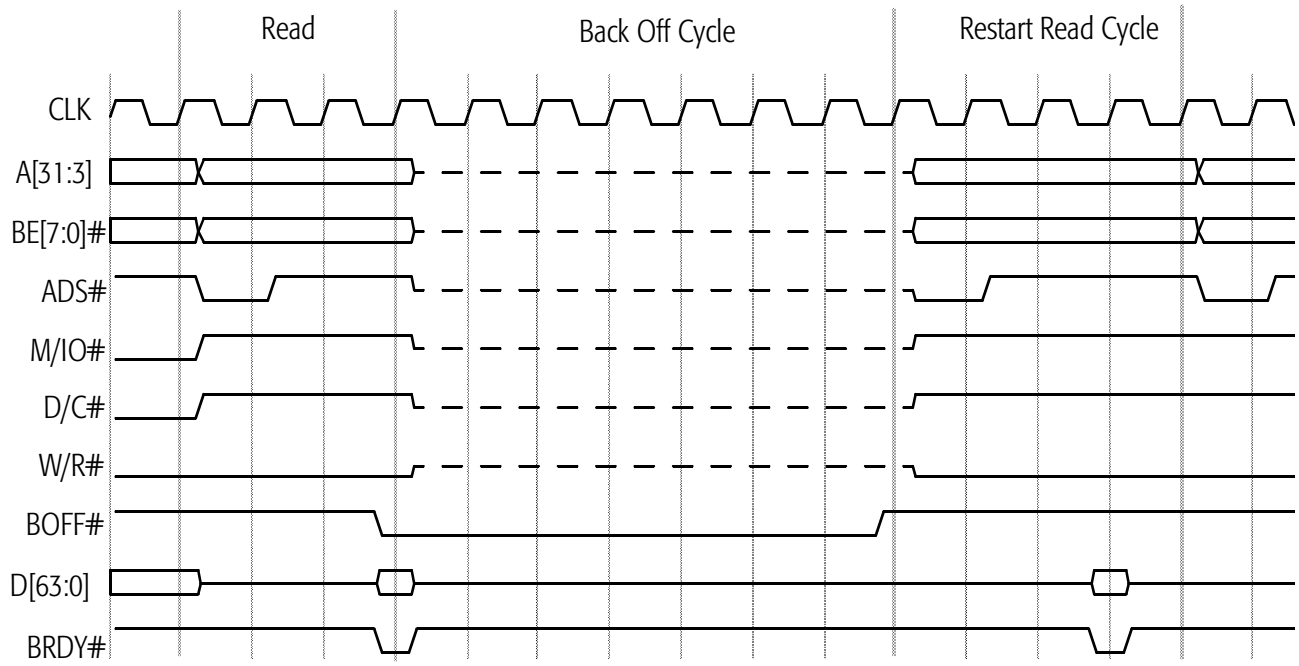

Figure 58. BOFF# Timing

Locked Cycles

The processor asserts LOCK# during a sequence of bus cycles to ensure the cycles are completed without allowing other bus masters to intervene. Locked operations can consist of two to five cycles. LOCK# is asserted during the following operations:

- An interrupt acknowledge sequence
- Descriptor Table accesses
- Page Directory and Page Table accesses
- XCHG instruction
- An instruction with an allowable LOCK prefix

In order to ensure that locked operations appear on the bus and are visible to the entire system, any data operands addressed during a locked cycle that reside in the processor's cache are flushed and invalidated from the cache prior to the locked operation. If the cache line is in the modified state, it is written back and invalidated prior to the locked operation. Likewise, any data read during a locked operation is not cached. The processor negates LOCK# for at least one clock between consecutive sequences of locked operations to allow the system logic to arbitrate for the bus.

The processor asserts SCYC during misaligned locked transfers on the D[63:0] data bus. The processor generates additional bus cycles to complete the transfer of misaligned data.

Basic Locked Operation

Figure 59 on page 153 shows a pair of read-write bus cycles. It represents a typical read-modify-write locked operation. The processor asserts LOCK# off the same clock edge that it asserts ADS# of the first bus cycle in the locked operation and holds it asserted until the last expected BRDY# of the last bus cycle in the locked operation is sampled asserted. (The processor negates LOCK# off the same clock edge.)

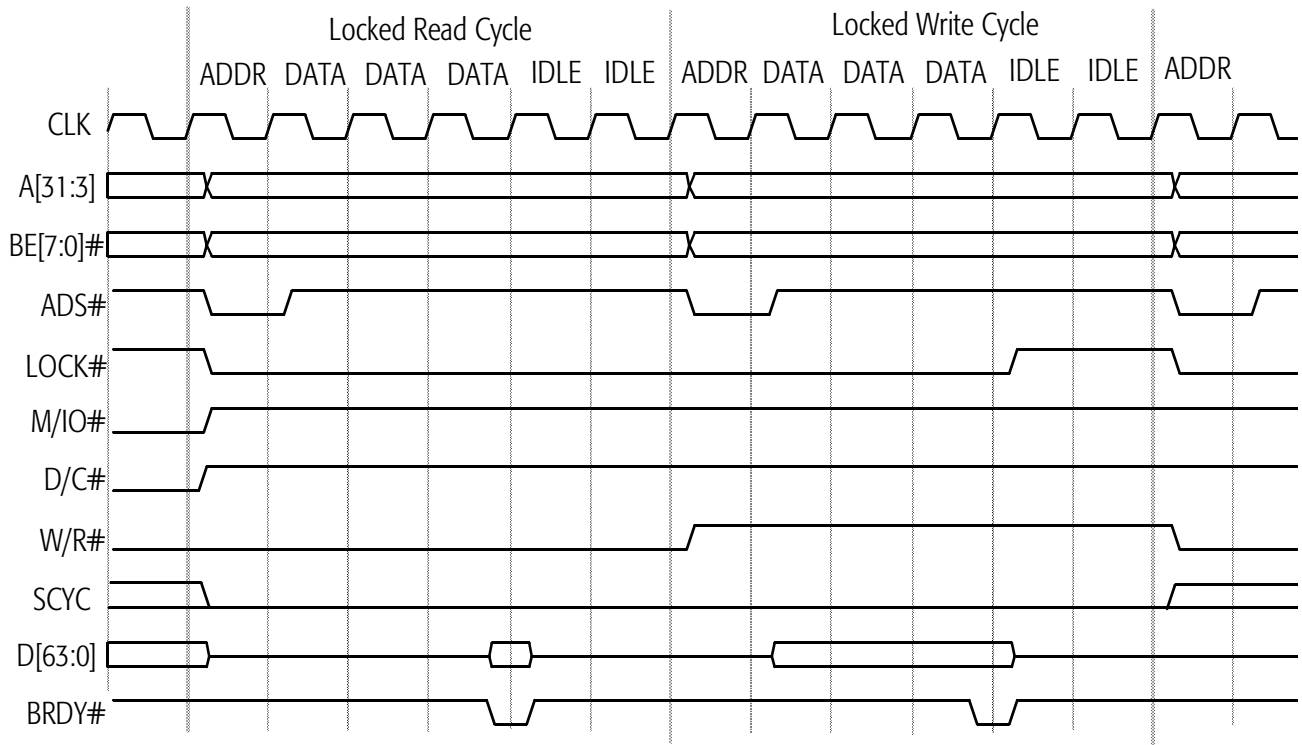

Figure 59. Basic Locked Operation

**Locked Operation
with BOFF#
Intervention**

Figure 60 on page 155 shows BOFF# asserted within a locked read-write pair of bus cycles. In this example, the processor asserts LOCK# with ADS# to drive a locked memory read cycle followed by a locked memory write cycle. During the locked memory write cycle in this example, the processor samples BOFF# asserted. The processor immediately aborts the locked memory write cycle and floats all its bus-driving signals, including LOCK#. The system logic or another bus master can initiate an inquire cycle or drive a new bus cycle one clock edge after the clock edge on which BOFF# is sampled asserted. If the system logic drives a BOFF#-initiated inquire cycle and hits a modified line, the processor performs a writeback cycle before it restarts the locked cycle (the processor asserts LOCK# during the writeback cycle).

In Figure 60, the processor immediately restarts the aborted locked write cycle by driving the bus off the clock edge on which BOFF# is sampled negated. The system logic must ensure the processor results for interrupted and uninterrupted locked cycles are consistent. That is, the system logic must guarantee the memory accessed by the processor is not modified during the time another bus master controls the bus.

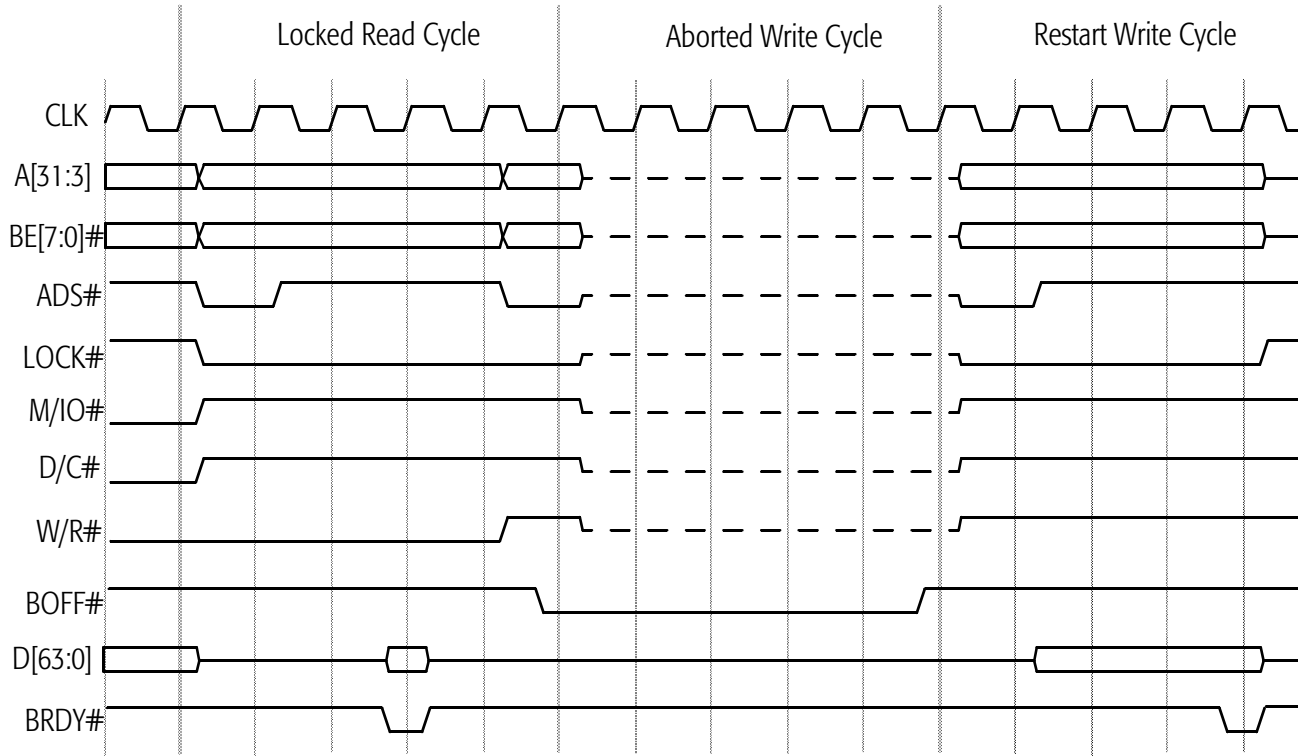

Figure 60. Locked Operation with BOFF# Intervention

Interrupt Acknowledge

In response to recognizing the system's maskable interrupt (INTR), the processor drives an interrupt acknowledge cycle at the next instruction boundary. During an interrupt acknowledge cycle, the processor drives a locked pair of read cycles as shown in Figure 61 on page 157. The first read cycle is not functional, and the second read cycle returns the interrupt number on D[7:0] (00h–FFh). Table 23 shows the state of the signals during an interrupt acknowledge cycle.

Table 23. Interrupt Acknowledge Operation Definition

Processor Outputs	First Bus Cycle	Second Bus Cycle
D/C#	Low	Low
M/IO#	Low	Low
W/R#	Low	Low
BE[7:0]#	EFh	FEh (low byte enabled)
A[31:3]	0000_0000h	0000_0000h
D[63:0]	(ignored)	Interrupt number expected from interrupt controller on D[7:0]

The system logic can drive INTR either synchronously or asynchronously. If it is asserted asynchronously, it must be asserted for a minimum pulse width of two clocks. To ensure it is recognized, INTR must remain asserted until an interrupt acknowledge sequence is complete.

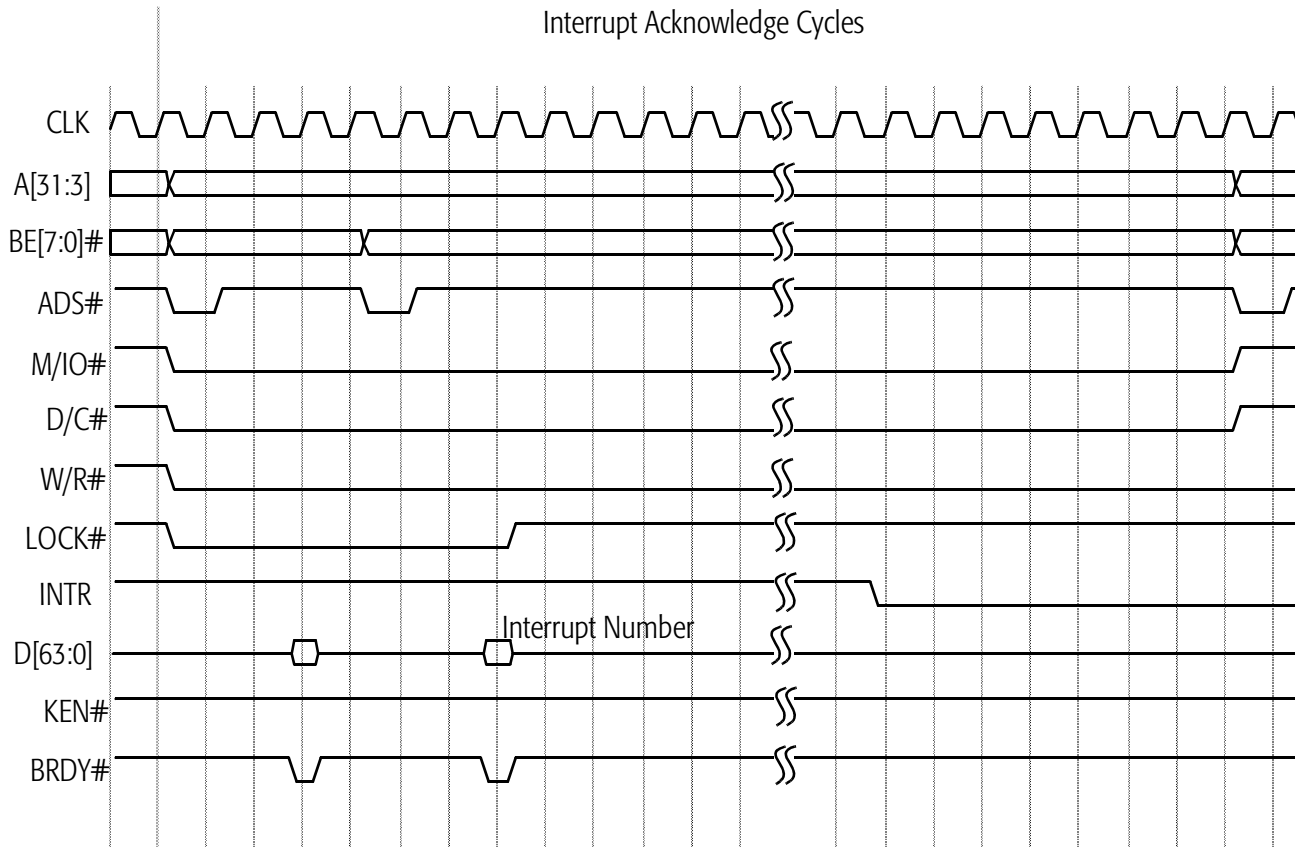

Figure 61. Interrupt Acknowledge Operation

6.6 Special Bus Cycles

The AMD-K6 processor drives special bus cycles that include stop grant, flush acknowledge, cache writeback invalidation, halt, cache invalidation, and shutdown cycles. During all special cycles, D/C# = 0, M/IO# = 0, and W/R# = 1. BE[7:0]# and A[31:3] are driven to differentiate among the special cycles, as shown in Table 24. The system logic must return BRDY# in response to all processor special cycles.

Table 24. Encodings For Special Bus Cycles

BE[7:0]#	A[4:3]*	Special Bus Cycle	Cause
FBh	10b	Stop Grant	STPCLK# sampled asserted
EFh	00b	Flush Acknowledge	FLUSH# sampled asserted
F7h	00b	Writeback	WBINVD instruction
FBh	00b	Halt	HLT instruction
FDh	00b	Flush	INVD,WBINVD instruction
FEh	00b	Shutdown	Triple fault
Note: * A[31:5] = 0			

Basic Special Bus Cycle

Figure 62 on page 159 shows a basic special bus cycle. The processor drives D/C# = 0, M/IO# = 0, and W/R# = 1 off the same clock edge that it asserts ADS#. In this example, BE[7:0]# = FBh and A[31:3] = 0000_0000h, which indicates that the special cycle is a halt special cycle (See Table 24). A halt special cycle is generated after the processor executes the HLT instruction.

If the processor samples FLUSH# asserted, it writes back any data cache lines that are in the modified state and invalidates all lines in the instruction and data cache. The processor then drives a flush acknowledge special cycle.

If the processor executes a WBINVD instruction, it drives a writeback special cycle after the processor completes invalidating and writing back the cache lines.

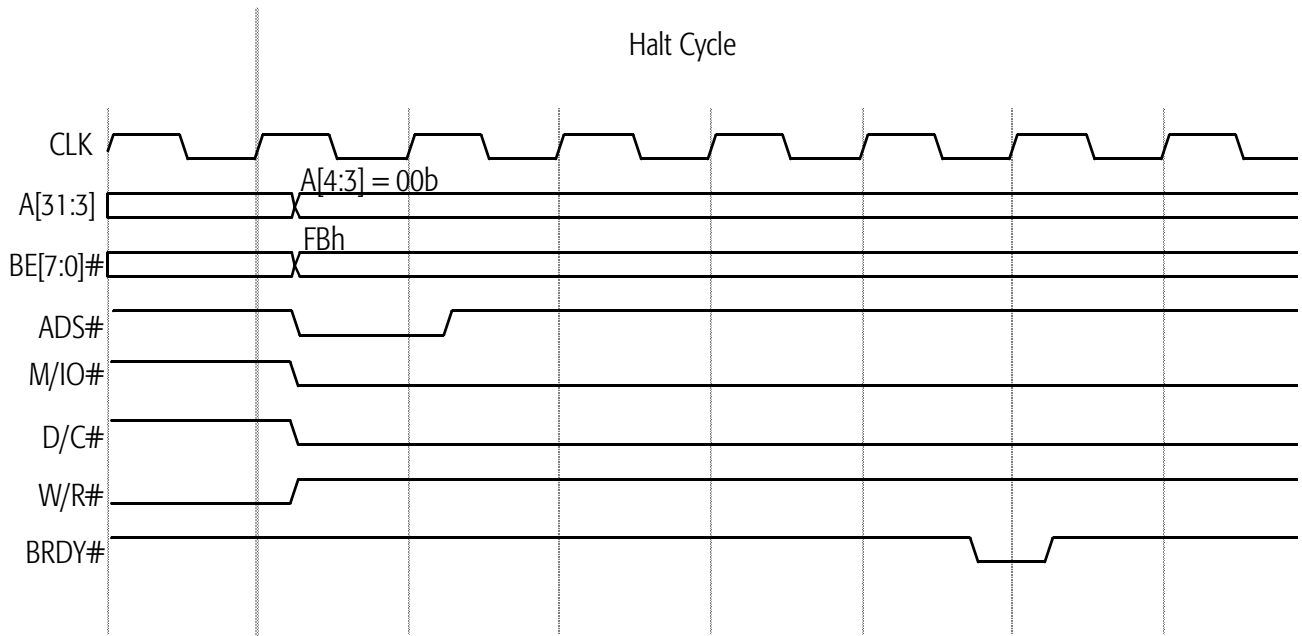

Figure 62. Basic Special Bus Cycle (Halt Cycle)

Shutdown Cycle

In Figure 63, a shutdown (triple fault) occurs in the first half of the waveform, and a shutdown special cycle follows in the second half. The processor enters shutdown when an interrupt or exception occurs during the handling of a double fault (INT 8), which amounts to a triple fault. When the processor encounters a triple fault, it stops its activity on the bus and generates the shutdown special bus cycle (BE[7:0]# = FEh).

The system logic must assert NMI, INIT, RESET, or SMI# to get the processor out of the shutdown state.

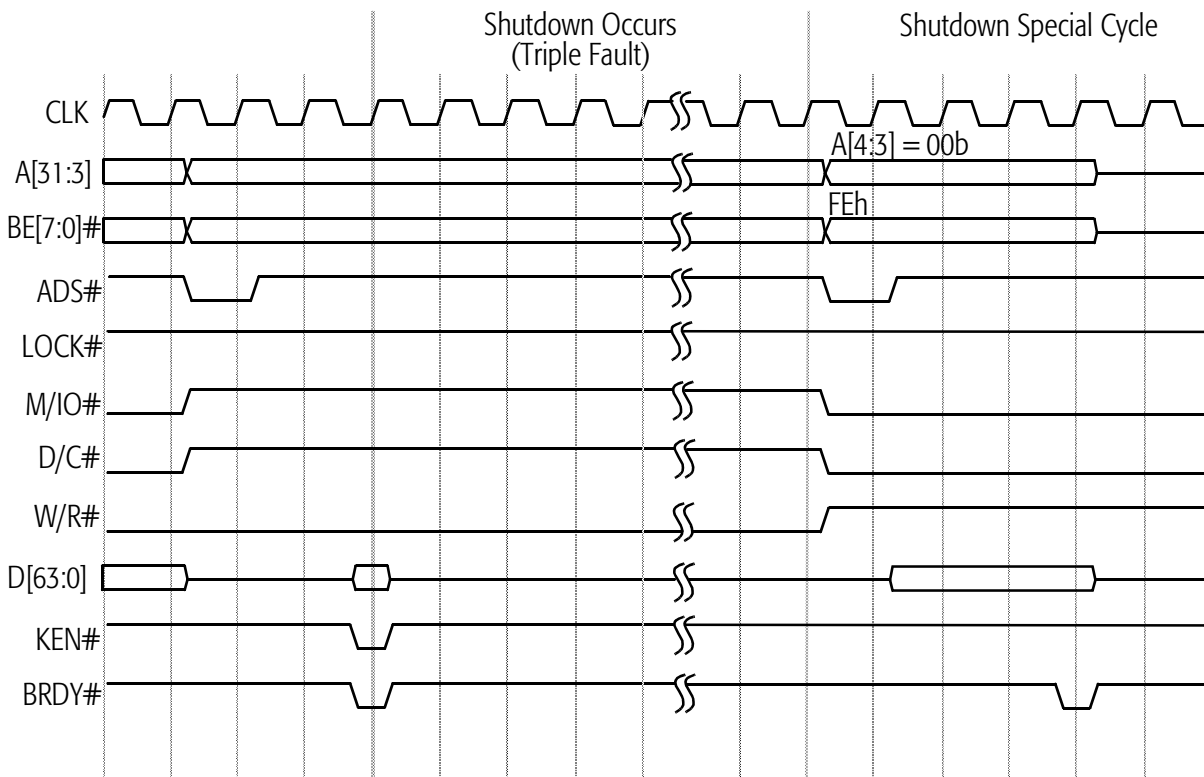

Figure 63. Shutdown Cycle

Stop Grant and Stop Clock States

Figure 64 on page 162 and Figure 65 on page 163 show the processor transition from normal execution to the Stop Grant state, then to the Stop Clock state, back to the Stop Grant state, and finally back to normal execution. The series of transitions begins when the processor samples STPCLK# asserted. On recognizing a STPCLK# interrupt at the next instruction retirement boundary, the processor performs the following actions, in the order shown:

1. Its instruction pipelines are flushed
2. All pending and in-progress bus cycles are completed
3. The STPCLK# assertion is acknowledged by executing a Stop Grant special bus cycle
4. Its internal clock is stopped after BRDY# of the Stop Grant special bus cycle is sampled asserted and after EWBE# is sampled asserted
5. The Stop Clock state is entered if the system logic stops the bus clock CLK (optional)

STPCLK# is sampled as a level-sensitive input on every clock edge but is not recognized until the next instruction boundary. The system logic drives the signal either synchronously or asynchronously. If it is asserted asynchronously, it must be asserted for a minimum pulse width of two clocks. STPCLK# must remain asserted until recognized, which is indicated by the completion of the Stop Grant special cycle.

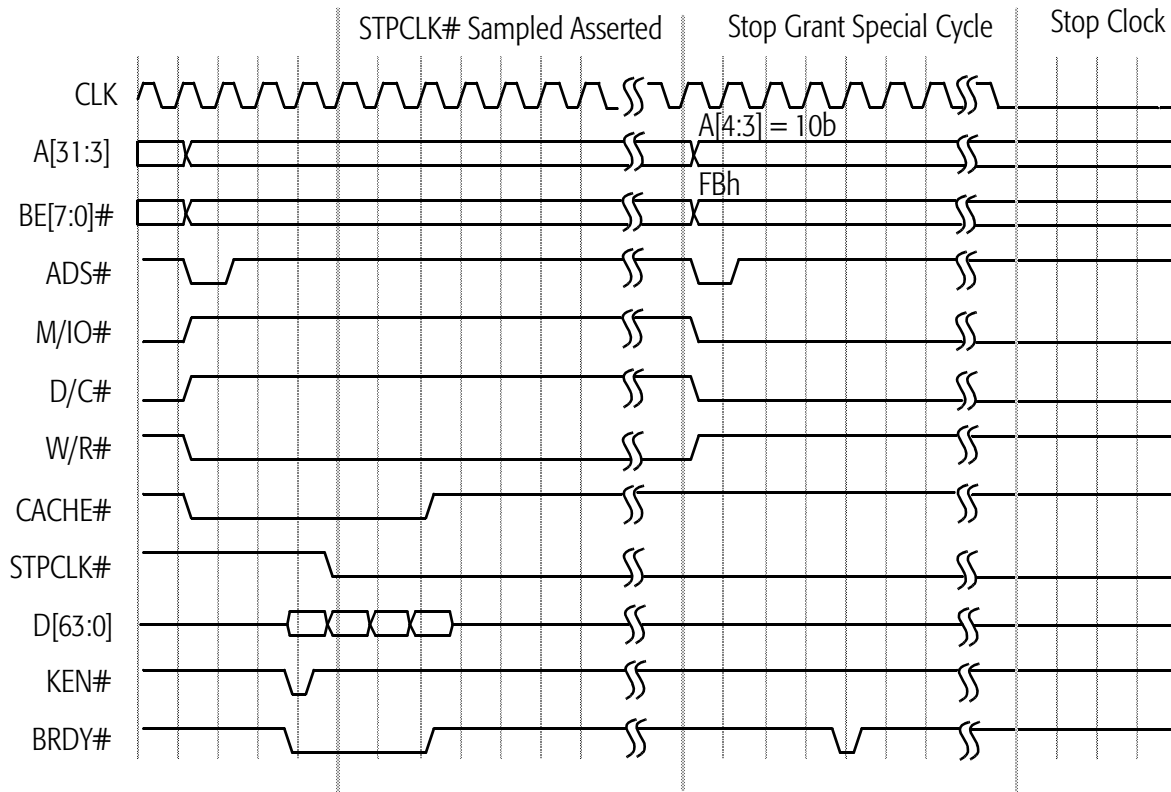

Figure 64. Stop Grant and Stop Clock Modes, Part 1

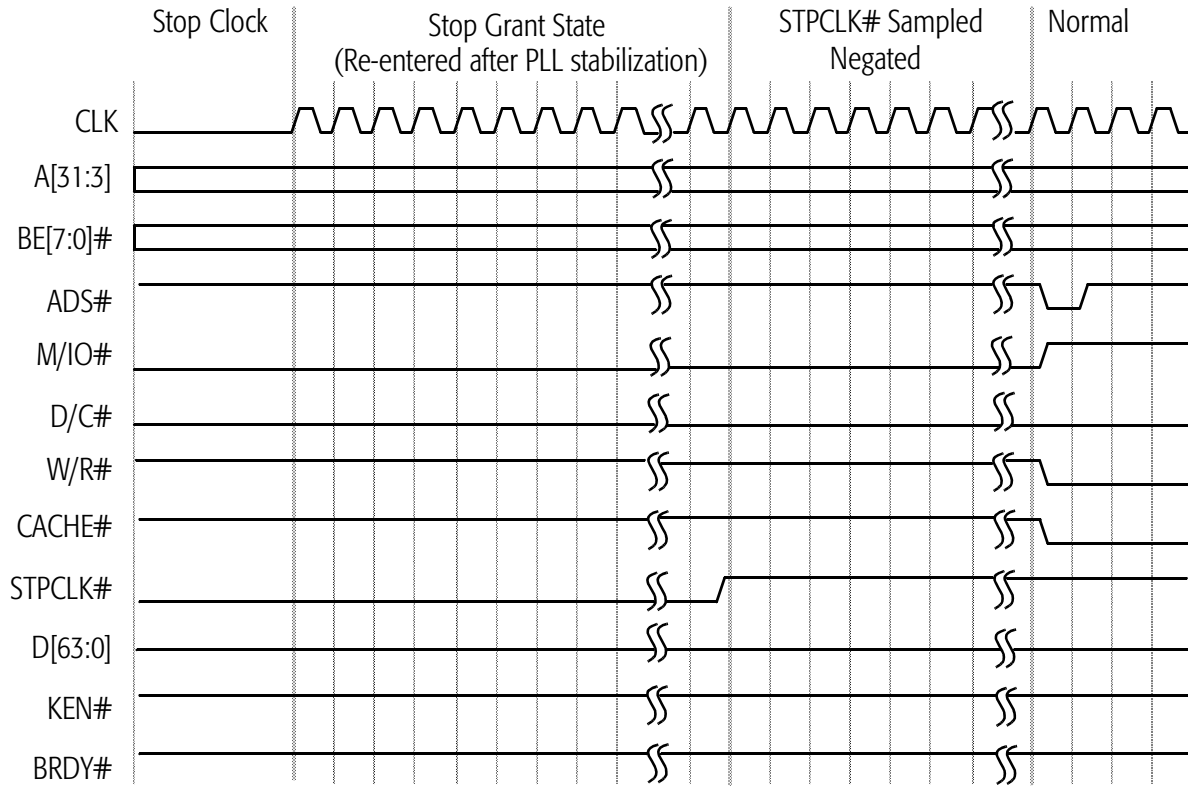

Figure 65. Stop Grant and Stop Clock Modes, Part 2

**INIT-Initiated
Transition from
Protected Mode to
Real Mode**

INIT is typically asserted in response to a BIOS interrupt that writes to an I/O port. This interrupt is often in response to a Ctrl-Alt-Del keyboard input. The BIOS writes to a port (similar to port 64h in the keyboard controller) that asserts INIT. INIT is also used to support 80286 software that must return to Real mode after accessing extended memory in Protected mode.

The assertion of INIT causes the processor to empty its pipelines, initialize most of its internal state, and branch to address FFFF_FFF0h—the same instruction execution starting point used after RESET. Unlike RESET, the processor preserves the contents of its caches, the floating-point state, the MMX state, Model-Specific Registers (MSRs), the CD and NW bits of the CR0 register, the time stamp counter, and other specific internal resources.

Figure 66 on page 165 shows an example in which the operating system writes to an I/O port, causing the system logic to assert INIT. The sampling of INIT asserted starts an extended microcode sequence that terminates with a code fetch from FFFF_FFF0h, the reset location. INIT is sampled on every clock edge but is not recognized until the next instruction boundary. During an I/O write cycle, it must be sampled asserted a minimum of three clock edges before BRDY# is sampled asserted if it is to be recognized on the boundary between the I/O write instruction and the following instruction. If INIT is asserted synchronously, it can be asserted for a minimum of one clock. If it is asserted asynchronously, it must have been negated for a minimum of two clocks, followed by an assertion of a minimum of two clocks.

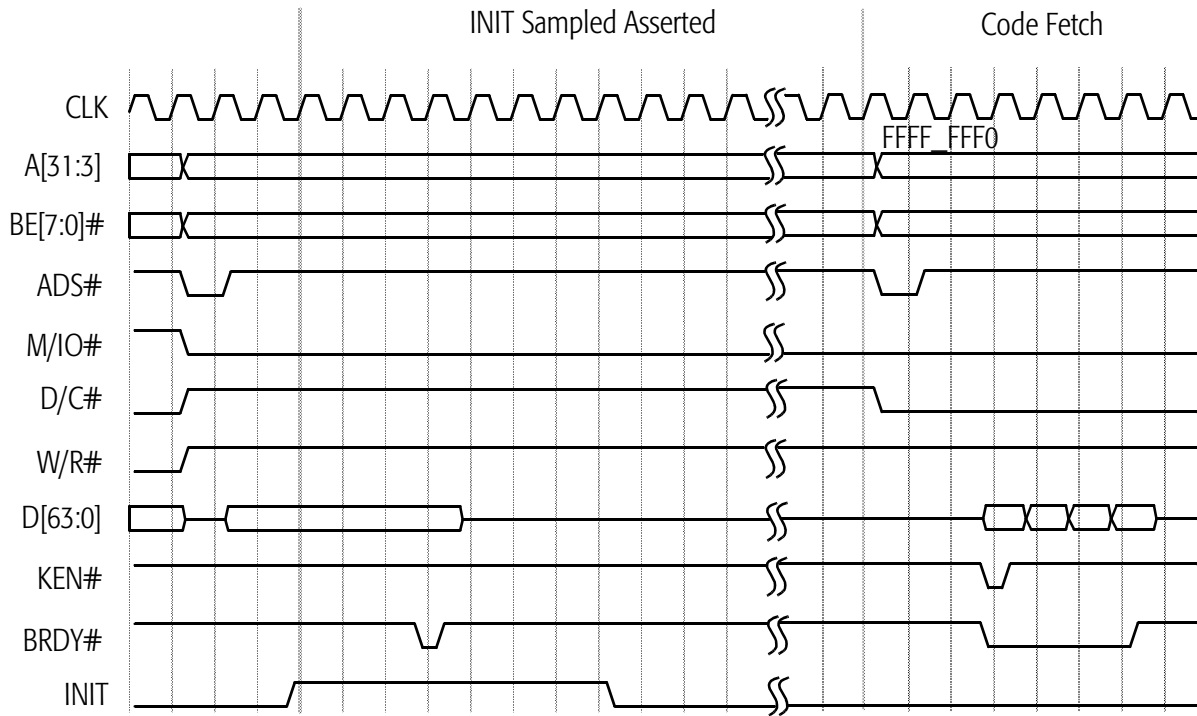

Figure 66. INIT-Initiated Transition from Protected Mode to Real Mode

7 Power-on Configuration and Initialization

On power-on the system logic must reset the AMD-K6 processor by asserting the RESET signal. When the processor samples RESET asserted, it immediately flushes and initializes all internal resources and its internal state, including its pipelines and caches, the floating-point state, the MMX state, and all registers. Then the processor jumps to address FFFF_FFF0h to start instruction execution.

7.1 Signals Sampled During the Falling Transition of RESET

- FLUSH#** FLUSH# is sampled on the falling transition of RESET to determine if the processor begins normal instruction execution or enters Tri-State Test mode. If FLUSH# is High during the falling transition of RESET, the processor unconditionally runs its Built-In Self Test (BIST), performs the normal reset functions, then jumps to address FFFF_FFF0h to start instruction execution. (See “Built-In Self-Test (BIST)” on page 203 for more details.) If FLUSH# is Low during the falling transition of RESET, the processor enters Tri-State Test mode. (See “Tri-State Test Mode” on page 204 and “FLUSH# (Cache Flush)” on page 97 for more details.)
- BF[2:0]** The internal operating frequency of the processor is determined by the state of the bus frequency signals BF[2:0] when they are sampled during the falling transition of RESET. The frequency of the CLK input signal is multiplied internally by a ratio defined by BF[2:0]. (See “BF[2:0] (Bus Frequency)” on page 86 for the processor-clock to bus-clock ratios.)
- BRDYC#** BRDYC# is sampled on the falling transition of RESET to configure the drive strength of A[20:3], ADS#, HITM#, and W/R#. If BRDYC# is Low during the fall of RESET, these outputs are configured using higher drive strengths than the standard strength. If BRDYC# is High during the fall of RESET, the standard strength is selected. (See “BRDYC# (Burst Ready Copy)” on page 89 for more details.)

7.2 RESET Requirements

During the initial power-on reset of the processor, RESET must remain asserted for a minimum of 1.0 ms after CLK and V_{CC} reach specification. (See “CLK Switching Characteristics” on page 241 for clock specifications. See “Electrical Data” on page 233 for V_{CC} specifications.)

During a warm reset while CLK and V_{CC} are within specification, RESET must remain asserted for a minimum of 15 clocks prior to its negation.

7.3 State of Processor After RESET

Output Signals

Table 25 shows the state of all processor outputs and bidirectional signals immediately after RESET is sampled asserted.

Table 25. Output Signal State After RESET

Signal	State	Signal	State
A[31:3], AP	Floating	HLDA	Low
ADS#, ADSC#	High	LOCK#	High
APCHK#	High	M/IO#	Low
BE[7:0]#	Floating	PCD	Low
BREQ	Low	PCHK#	High
CACHE#	High	PWT	Low
D/C#	Low	SCYC	Low
D[63:0], DP[7:0]	Floating	SMIACK#	High
FERR#	High	TDO	Floating
HIT#	High	VCC2DET	Low
HITM#	High	W/R#	Low

Registers

Table 26 on page 169 shows the state of all architecture registers and Model-Specific Registers (MSRs) after the processor has completed its initialization due to the recognition of the assertion of RESET.

Table 26. Register State After RESET

Register	State (hex)	Notes
GDTR	base:0000_0000h limit:0FFFFh	
IDTR	base:0000_0000h limit:0FFFFh	
TR	0000h	
LDTR	0000h	
EIP	FFFF_FFF0h	
EFLAGS	0000_0002h	
EAX	0000_0000h	1
EBX	0000_0000h	
ECX	0000_0000h	
EDX	0000_056Xh	2
ESI	0000_0000h	
EDI	0000_0000h	
EBP	0000_0000h	
ESP	0000_0000h	
CS	F000h	
SS	0000h	
DS	0000h	
ES	0000h	
FS	0000h	
GS	0000h	
FPU Stack R7–R0	0000_0000_0000_0000_0000h	3
FPU Control Word	0040h	3
FPU Status Word	0000h	3
FPU Tag Word	5555h	3
FPU Instruction Pointer	0000_0000_0000h	3
FPU Data Pointer	0000_0000_0000h	3
FPU Opcode Register	000_0000_0000b	3
CR0	6000_0010h	4
CR2	0000_0000h	
Notes:		
<ol style="list-style-type: none"> 1. The contents of EAX indicate if BIST was successful. If EAX = 0000_0000h, BIST was successful. If EAX is non-zero, BIST failed. 2. EDX contains the AMD-K6 processor signature, where X indicates the processor Stepping ID. 3. The contents of these registers are preserved following the recognition of INIT. 4. The CD and NW bits of CR0 are preserved following the recognition of INIT. 		

Table 26. Register State After RESET (continued)

Register	State (hex)	Notes
CR3	0000_0000h	
CR4	0000_0000h	
DR7	0000_0400h	
DR6	FFFF_0FF0h	
DR3	0000_0000h	
DR2	0000_0000h	
DR1	0000_0000h	
DR0	0000_0000h	
MCAR	0000_0000_0000_0000h	3
MCTR	0000_0000_0000_0000h	3
TR12	0000_0000_0000_0000h	3
TSC	0000_0000_0000_0000h	3
WHCR	0000_0000_0000_0000h	3
Notes:		
<ol style="list-style-type: none"> 1. The contents of EAX indicate if BIST was successful. If EAX = 0000_0000h, BIST was successful. If EAX is non-zero, BIST failed. 2. EDX contains the AMD-K6 processor signature, where X indicates the processor Stepping ID. 3. The contents of these registers are preserved following the recognition of INIT. 4. The CD and NW bits of CR0 are preserved following the recognition of INIT. 		

7.4 State of Processor After INIT

The recognition of the assertion of INIT causes the processor to empty its pipelines, to initialize most of its internal state, and to branch to address FFFF_FFF0h—the same instruction execution starting point used after RESET. Unlike RESET, the processor preserves the contents of its caches, the floating-point state, the MMX state, MSRs, and the CD and NW bits of the CR0 register.

The edge-sensitive interrupts FLUSH# and SMI# are sampled and preserved during the INIT process and are handled accordingly after the initialization is complete. However, the processor resets any pending NMI interrupt upon sampling INIT asserted.

INIT can be used as an accelerator for 80286 code that requires a reset to exit from Protected mode back to Real mode.

8 Cache Organization

The following sections describe the basic architecture and resources of the AMD-K6 processor internal caches.

The performance of the AMD-K6 processor is enhanced by a writeback level-one (L1) cache. The cache is organized as a separate 32-Kbyte instruction cache and a 32-Kbyte data cache, each with two-way set associativity (See Figure 67). The cache line size is 32 bytes, and lines are prefetched from main memory using an efficient, pipelined burst transaction. As the instruction cache is filled, each instruction byte is analyzed for instruction boundaries using predecode logic. Predecoding annotates each instruction byte with information that later enables the decoders to efficiently decode multiple instructions simultaneously. Translation lookaside buffers (TLB) are also used to translate linear addresses to physical addresses. The instruction cache is associated with a 64-entry TLB while the data cache is associated with a 128-entry TLB.

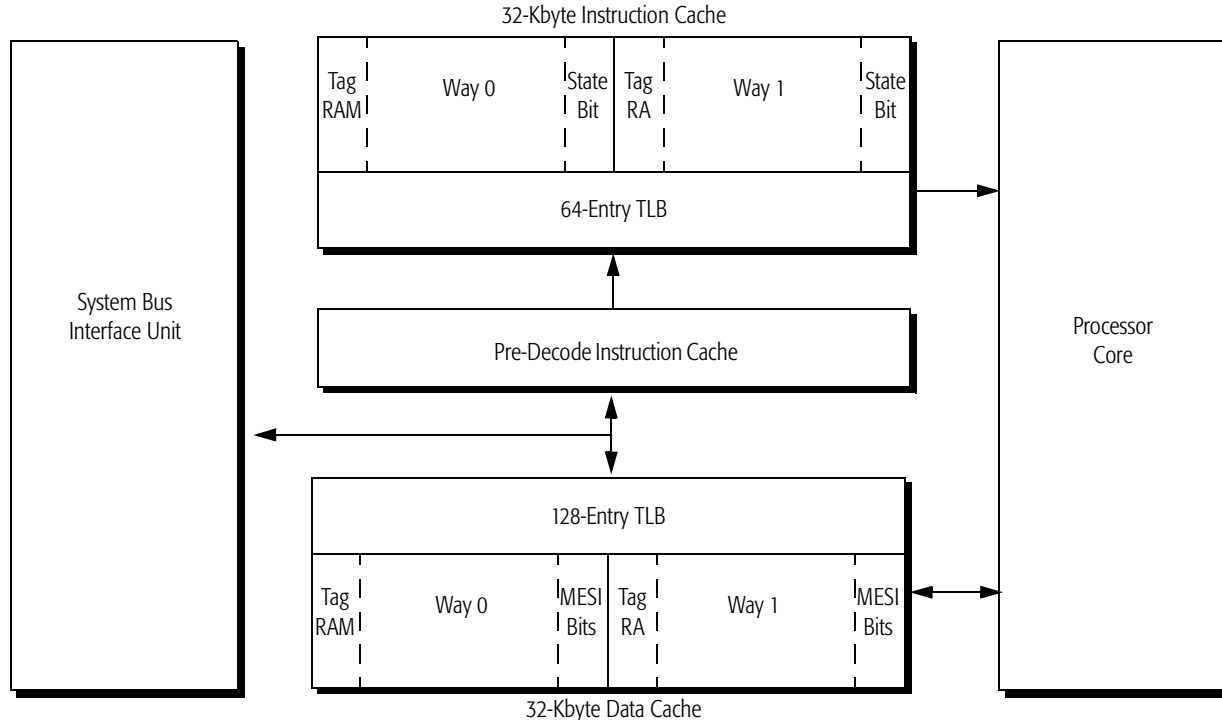

Figure 67. Cache Organization

The processor cache design takes advantage of a sectored organization (See Figure 68). Each sector consists of 64 bytes configured as two 32-byte cache lines. The two cache lines of a sector share a common tag but have separate MESI (modified, exclusive, shared, invalid) bits that track the state of each cache line.

Instruction Cache Line

Tag	Cache Line 1	Byte 31	Predecode Bits	Byte 30	Predecode Bits	Byte 0	Predecode Bits	1 MESI Bit
Address	Cache Line 2	Byte 31	Predecode Bits	Byte 30	Predecode Bits	Byte 0	Predecode Bits	1 MESI Bit

Data Cache Line

Tag	Cache Line 1	Byte 31	Byte 30	Byte 0	2 MESI Bits
Address	Cache Line 2	Byte 31	Byte 30	Byte 0	2 MESI Bits

Note: *Instruction-cache lines have only two coherency states (valid or invalid) rather than the four MESI coherency states of data-cache lines. Only two states are needed for the instruction cache because these lines are read-only.*

Figure 68. Cache Sector Organization

8.1 MESI States in the Data Cache

The state of each line in the caches is tracked by the MESI bits. The coherency of these states or MESI bits is maintained by internal processor snoops and external inquiries by the system logic. The following four states are defined for the data cache:

- *Modified*—This line has been modified and is different from main memory.
- *Exclusive*—This line is not modified and is the same as main memory. If this line is written to, it becomes Modified.
- *Shared*—If a cache line is in the shared state it means that the same line can exist in more than one cache system.
- *Invalid*—The information in this line is not valid.

8.2 Predecode Bits

Decoding x86 instructions is particularly difficult because the instructions vary in length, ranging from 1 to 15 bytes long. Predecode logic supplies the predecode bits associated with each instruction byte. The predecode bits indicate the number

of bytes to the start of the next x86 instruction. The predecode bits are passed with the instruction bytes to the decoders where they assist with parallel x86 instruction decoding. The predecode bits use memory separate from the 32-Kbyte instruction cache. The predecode bits are stored in an extended instruction cache alongside each x86 instruction byte as shown in Figure 68 on page 172.

8.3 Cache Operation

The operating modes for the caches are configured by software using the not writethrough (NW) and cache disable (CD) bits of control register 0 (CR0 bits 29 and 30 respectively). These bits are used in all operating modes.

When the CD and NW bits are both set to 0, the cache is fully enabled. This is the standard operating mode for the cache. If a read miss occurs when the processor reads from the cache, a line fill takes place. Write hits to the cache are updated, while write misses and writes to shared lines cause external memory updates.

Note: A write allocate operation can modify the behavior of write misses to the cache. See “Write Allocate” on page 177.

When CD is set to 0 and NW is set to 1, an invalid mode of operation exists that causes a general protection fault to occur.

When CD is set to 1 (disabled) and NW is set to 0, the cache fill mechanism is disabled but the contents of the cache are still valid. The processor reads from the cache and, if a read miss occurs, no line fills take place. Write hits to the cache are updated, while write misses and writes to shared lines cause external memory updates.

When the CD and NW bits are both set to 1, the cache is fully disabled. Even though the cache is disabled, the contents are not necessarily invalid. The processor reads from the cache and, if a read miss occurs, no line fills take place. If a write hit occurs, the cache is updated but an external memory update does not occur. If a data line is in the exclusive state during a write hit, the MESI bits are changed to the modified state. Write misses access memory directly.

The operating system can control the cacheability of a page. The paging mechanism is controlled by CR3, the Page Directory Entry (PDE), and the Page Table Entry (PTE). Within CR3, PDE, and PTE are Page Cache Disable (PCD) and Page Writethrough (PWT) bits. The values of the PCD and PWT bits used in Table 27 through Table 29 are taken from either the PTE or PDE. For more information see the descriptions of PCD and PWT on pages 107 and 109, respectively.

Table 27 through Table 29 describe the logic that determines the cacheability of a cycle and how that cacheability is affected by the PCD bits, the PWT bits, the PG bit of CR0, the CD bit of CR0, writeback cycles, the Cache Inhibit (CI) bit of Test Register 12 (TR12), and unlocked memory reads.

Table 27 describes how the PWT signal is driven based on the values of the PWT bits and the PG bit of CR0.

Table 27. PWT Signal Generation

PWT Bit*	PG Bit of CR0	PWT Signal
1	1	High
0	1	Low
1	0	Low
0	0	Low

Note:
* PWT is taken from PTE or PDE

Table 28 describes how the PCD signal is driven based on the values of the CD bit of CR0, the PCD bits, and the PG bit of CR0.

Table 28. PCD Signal Generation

CD Bit of CR0	PCD Bit*	PG Bit of CR0	PCD Signal
1	X	X	High
0	1	1	High
0	0	1	Low
0	1	0	Low
0	0	0	Low

Note:
* PCD is taken from PTE or PDE

Table 29 describes how the CACHE# signal is driven based on writeback cycles, the CI bit of TR12, unlocked memory reads, and the PCD signal.

Table 29. CACHE# Signal Generation

Writeback Cycle	CI Bit of TR12	Unlocked Memory Reads	PCD Signal	CACHE#
1	X	X	X	Low
0	1	1	High	High
0	0	1	High	High
0	1	0	High	High
0	0	0	High	High
0	1	1	Low	High
0	0	1	Low	Low
0	1	0	Low	High
0	0	0	Low	High

Cache-Related Signals

Complete descriptions of the signals that control cacheability and cache coherency are given on the following pages:

- CACHE#—page 90
- EADS#—page 94
- FLUSH#—page 97
- HIT#—page 98
- HITM#—page 98
- INV—page 102
- KEN#—page 103
- PCD—page 107
- PWT—page 109
- WB/WT#—page 116

8.4 Cache Disabling

To completely disable all cache accesses, the CD and NW bits must be set to 1 and the cache must be completely flushed.

There are two different methods for flushing the cache. The first method relies on the system logic and the second relies on software.

For the system logic to flush the cache, the processor must sample FLUSH# asserted. In this method, the processor writes back any data cache lines that are in the modified state, invalidates all lines in the instruction and data caches, and then executes a flush acknowledge special cycle (See Table 19 on page 119).

Software can use two different instructions to flush the cache. Both the WBINVD and INVD instructions cause all cache lines to be marked invalid. The WBINVD instruction causes all modified lines to first be written back to memory. The INVD instruction invalidates all cache lines without writing modified lines back to memory.

Any area of system memory can be cached. However, the processor prevents caching of locked operations and TLB reads, the operating system can prevent caching of certain pages by setting the PCD and PWT bits in the PDE or PTE, and system logic can prevent caching of certain bus cycles by negating the KEN# input signal with the first BRDY# or NA# of a cycle.

8.5 Cache-Line Fills

When the CPU needs to read memory, the processor drives a read cycle onto the bus. If the cycle is cacheable the CPU asserts CACHE#. The system logic also has control of the cacheability of bus cycles. If it determines the address is cacheable, system logic asserts the KEN# signal and the appropriate value of WB/WT#.

One of two events takes place next. If the cycle is not cacheable, a non-pipelined, single-transfer read takes place. The processor waits for the system logic to return the data and assert a single BRDY# (See Figure 45 on page 127). If the cycle is cacheable, the processor executes a 32-byte burst read cycle. The processor expects to sample BRDY# asserted a total of four times for a burst read cycle to take place (See Figure 47 on page 131).

Instruction-cache line fills initiate 32-byte transfers from memory (one burst cycle) on the bus. Data-cache line fills also initiate 32-byte transfers on the bus. If the data-cache line being filled replaces a modified line, the prior contents of the line are copied to a 32-byte writeback (copyback) buffer in the bus interface unit while the new line is being read.

8.6 Cache-Line Replacements

As programs execute and task switches occur, some cache lines eventually require replacement.

Instruction cache lines are replaced using a Least Recently Used (LRU) algorithm. If line replacement is required, lines are replaced when read cache misses occur.

The data cache uses a slightly different approach to line replacement. If a miss occurs, and a replacement is required, lines are replaced by using a Least Recently Allocated (LRA) algorithm.

Two forms of cache misses and associated cache fills can take place—a sector replacement and a cache line replacement. In the case of a sector replacement, the miss is due to a tag mismatch, in which case the required cache line is filled from external memory, and the cache line within the sector that was not required is marked as invalid. In the case of a cache line replacement, the address matches the tag, but the requested cache line is marked as invalid. The required cache line is filled from external memory, and the cache line within the sector that is not required remains in the same cache state.

8.7 Write Allocate

Write allocate, if enabled, occurs when the processor has a pending memory write cycle to a cacheable line and the line does not currently reside in the L1 data cache. In this case, the processor performs a burst read cycle to fetch the data-cache line addressed by the pending write cycle. The data associated with the pending write cycle is merged with the recently-allocated data-cache line and stored in the processor's L1 data cache. The final MESI state of the cache line depends on the state of the WB/WT# and PWT signals during the burst read cycle and the subsequent cache write hit (See Table 30 on page 182 to determine the cache-line states and the access types following a cache read miss and cache write hit).

During write allocates, a 32-byte burst read cycle is executed in place of a non-burst write cycle. While the burst read cycle generally takes longer to execute than the write cycle, performance gains are realized on subsequent write cycle hits

to the write-allocated cache line. Due to the nature of software, memory accesses tend to occur in proximity of each other (principle of locality). The likelihood of additional write hits to the write-allocated cache line is high.

The following is a description of three mechanisms by which the AMD-K6 processor performs write allocations. A write allocate is performed when any one or more of these mechanisms indicates that a pending write is to a cacheable area of memory.

Write to a Cacheable Page

Every time the processor performs a cache line fill, the address of the page in which the cache line resides is saved in the Cacheability Control Register (CCR). The page address of subsequent write cycles is compared with the page address stored in the CCR. If the two addresses are equal, then the processor performs a write allocate because the page has already been determined to be cacheable.

When the processor performs a cache line fill from a different page than the address saved in the CCR, the CCR is updated with the new page address.

Write to a Sector

If the address of a pending write cycle matches the tag address of a valid cache sector, but the addressed cache line within the sector is marked invalid (a sector hit but a cache line miss), then the processor performs a write allocate. The pending write cycle is determined to be cacheable because the sector hit indicates the presence of at least one valid cache line in the sector. The two cache lines within a sector are guaranteed by design to be within the same page.

Write Allocate Limit

The Write Handling Control Register (WHCR) is a MSR that contains three fields—the WCDE bit, the Write Allocate Enable Limit (WAELIM) field, and the Write Allocate Enable 15-to-16-Mbyte (WAE15M) bit (See Figure 69 on page 179).

For proper functionality, always program the WCDE bit to 0.

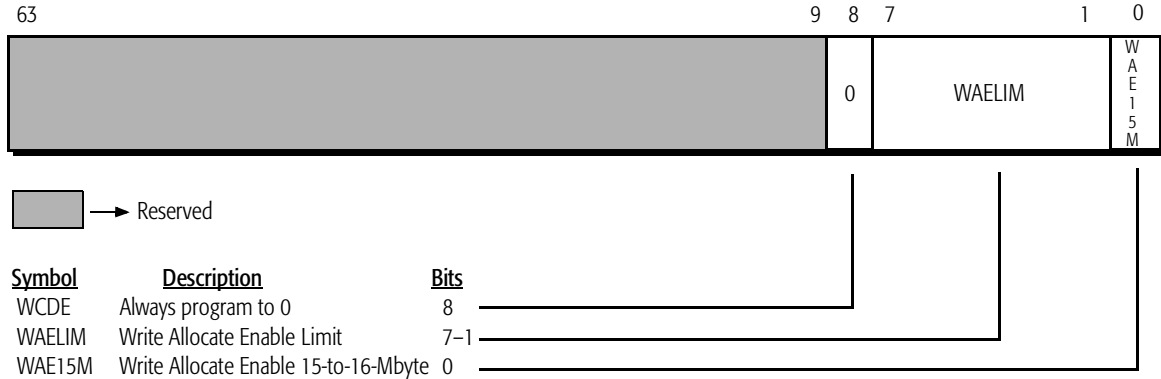

Note: Hardware RESET initializes this MSR to all zeros.

Figure 69. Write Handling Control Register (WHCR)

The WAE15M field is 7 bits wide. This field, multiplied by 4 Mbytes, defines an upper memory limit. Any pending write cycle that addresses memory below this limit causes the processor to perform a write allocate. Write allocate is disabled for memory accesses at and above this limit unless the processor determines a pending write cycle is cacheable by means of one of the other write allocate mechanisms—Write to a Cacheable Page and Write to a Sector. The maximum value of this memory limit is $((2^7 - 1) \cdot 4 \text{ Mbytes}) = 508 \text{ Mbytes}$. When all the bits in this field are set to 0, all memory is above this limit and this mechanism for allowing write allocate is effectively disabled.

The Write Allocate Enable 15-to-16-Mbyte (WAE15M) bit is used to enable write allocations for the memory write cycles that address the 1 Mbyte of memory between 15 Mbytes and 16 Mbytes. This bit must be set to 1 to allow write allocate in this memory area. This bit is provided to account for a small number of uncommon memory-mapped I/O adapters that use this particular memory address space. If the system contains one of these peripherals, the bit should be set to 0. The WAE15M bit is ignored if the value in the WAE15M field is set to less than 16 Mbytes.

By definition a write allocate is never performed in the memory area between 640 Kbytes and 1 Mbyte unless the processor determines a pending write cycle is cacheable by means of one of the other write allocate mechanisms—Write to a Cacheable Page and Write to a Sector. It is not considered safe to perform

write allocations between 640 Kbytes and 1 Mbyte (000A_0000h to 000F_FFFFh) because it is considered a non-cacheable region of memory.

Figure 70 shows the logic flow for all the mechanisms involved with write allocate for memory bus cycles. The left side of the diagram (the text) describes the conditions that need to be true in order for the value of that line to be a 1. Items 1 to 3 of the diagram are related to general cache operation and items 4 to 11 are related to the write allocate mechanisms.

For more information about write allocate, see the *Implementation of Write Allocate in the K86™ Processors Application Note*, order# 21326.

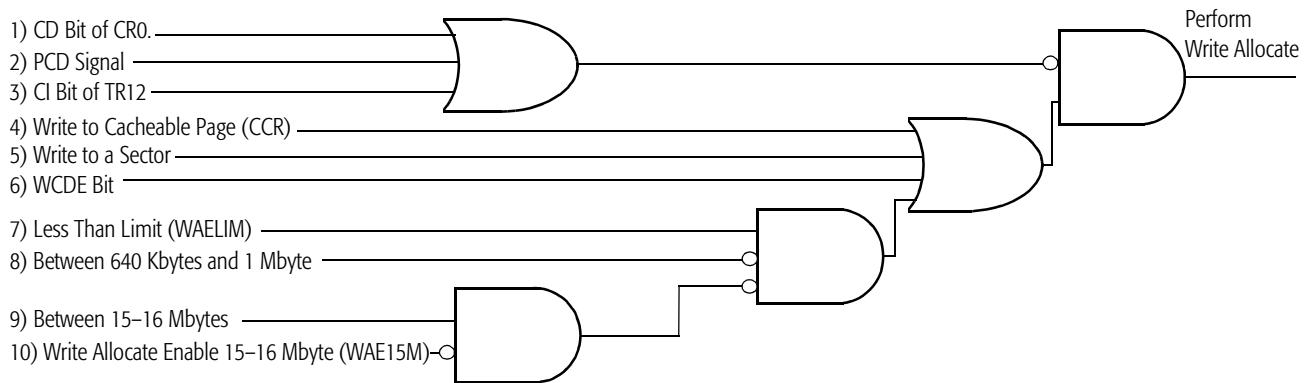

Figure 70. Write Allocate Logic Mechanisms and Conditions

Descriptions of the Logic Mechanisms and Conditions

1. *CD Bit of CR0*—When the cache disable (CD) bit within control register 0 (CR0) is set to 1, the cache fill mechanism for both reads and writes is disabled, therefore write allocate does not occur.
2. *PCD Signal*—When the PCD (page cache disable) signal is driven High, caching for that page is disabled even if KEN# is sampled asserted, therefore write allocate does not occur.
3. *CI Bit of TR12*—When the cache inhibit bit of Test Register 12 is set to 1, the L1 caches are disabled, therefore write allocate does not occur.
4. *Write to a Cacheable Page (CCR)*—A write allocate is performed if the processor knows that a page is cacheable. The CCR is used to store the page address of the last cache fill for a read miss. See “Write to a Cacheable Page” on page 178 for a detailed description of this condition.

5. *Write to a Sector*—A write allocate is performed if the address of a pending write cycle matches the tag address of a valid cache sector but the addressed cache line within the sector is invalid. See “Write to a Sector” on page 178 for a detailed description of this condition.
6. *WCDE Bit*—For proper functionality, always program bit 8 of WHCR to 0.
7. *Less Than Limit (WAELIM)*—The write allocate limit mechanism determines if the memory area being addressed is less than the limit set in the WAELIM field of WHCR. If the address is less than the limit, write allocate for that memory address is performed as long as conditions 9 and 10 do not prevent write allocate.
8. *Between 640 Kbytes and 1 Mbyte*—Write allocate is not performed in the memory area between 640 Kbytes and 1 Mbyte. It is not considered safe to perform write allocations between 640 Kbytes and 1 Mbyte (000A_0000h to 000F_FFFFh) because this area of memory is considered a non-cacheable region of memory.
9. *Between 15–16 Mbytes*—If the address of a pending write cycle is in the 1 Mbyte of memory between 15 Mbytes and 16 Mbytes, and the WAE15M bit is set to 1, write allocate for this cycle is enabled.
10. *Write Allocate Enable 15–16 Mbytes (WAE15M)*—This condition is associated with the Write Allocate Limit mechanism and affects write allocate only if the limit specified by the WAELIM field is greater than or equal to 16 Mbytes. If the memory address is between 15 Mbytes and 16 Mbytes, and the WAE15M bit in the WHCR is set to 0, write allocate for this cycle is disabled.

8.8 Prefetching

The AMD-K6 processor performs instruction cache prefetching for sector replacements only—as opposed to cache-line replacements. The cache prefetching results in the filling of the required cache line first, and a prefetch of the second cache line making up the other half of the sector. Furthermore, the prefetch of the second cache line is initiated only in the forward direction—that is, only if the requested cache line is the first position within the sector. From the perspective of the external

bus, the two cache-line fills typically appear as two 32-byte burst read cycles occurring back-to-back or, if allowed, as pipelined cycles. The burst read cycles do not occur back-to-back (wait states occur) if the processor is not ready to start a new cycle, if higher priority data read or write requests exist, or if NA# (next address) was sampled negated. Wait states can also exist between burst cycles if the processor samples AHOLD or BOFF# asserted.

8.9 Cache States

Table 30 shows all the possible cache-line states before and after program-generated accesses to individual cache lines. The table includes the correspondence between MESI states and writethrough or writeback states for lines in the data cache.

Table 30. Data Cache States for Read and Write Accesses

Type		Cache State Before Access	Access Type ¹	Cache State After Access	
				MESI State	Writeback Writethrough State
Cache Read	Read Miss	invalid	single read	invalid	–
		invalid	burst read ² (cacheable)	shared or exclusive ³	writethrough or writeback ³
	Read Hit	shared	–	shared	writethrough
		exclusive	–	exclusive	writeback
		modified	–	modified	writeback
Cache Write	Write Miss	invalid	single write ⁴	invalid	–
	Write Hit	shared	cache update and single write	shared or exclusive ³	writethrough or writeback ³
		exclusive or modified	cache update	modified	writeback

Notes:

1. Single read, single write, cache update, and writethrough = 1 to 8 bytes. Line fill = 32-byte burst read.
 2. If CACHE# is driven Low and KEN# is sampled asserted.
 3. If PWT is driven Low and WB/WT# is sampled High, the line is cached in the exclusive (writeback) state.
 4. A write cycle occurs only if the write allocate conditions as specified in "Write Allocate" on page 177 are not met.
- Not applicable or none.

8.10 Cache Coherency

Different ways exist to maintain coherency between the system memory and cache memories. Inquire cycles, internal snoops, FLUSH#, WBINVD, INVD, and line replacements all prevent inconsistencies between memories.

Inquire Cycles

Inquire cycles are bus cycles initiated by system logic. These inquiries ensure coherency between the caches and main memory. In systems with multiple caching masters, system logic maintains cache coherency by driving inquire cycles to the processor. System logic initiates inquire cycles by asserting AHOLD, BOFF#, or HOLD to obtain control of the address bus and then driving EADS#, INV (optional), and an inquire address (A[31:5]). This type of bus cycle causes the processor to compare the tags for both its instruction and data caches with the inquire address. If there is a hit to a shared or exclusive line in the data cache or a valid line in the instruction cache, the processor asserts HIT#. If the compare hits a modified line in the data cache, the processor asserts HIT# and HITM#. If HITM# is asserted, the processor writes the modified line back to memory. If INV was sampled asserted with EADS#, a hit invalidates the line. If INV was sampled negated with EADS#, a hit leaves the line in the shared state or transitions it from the exclusive or modified to shared state.

Internal Snooping

Internal snooping is initiated by the processor (rather than system logic) during certain cache accesses. It is used to maintain coherency between the L1 instruction and data caches.

The processor automatically snoops its instruction cache during read or write misses to its data cache, and it snoops its data cache during read misses to its instruction cache. Table 31 on page 185 summarizes the actions taken during this internal snooping.

If an internal snoop hits its target, the processor does the following:

- *Data cache snoop during an instruction-cache read miss*—If modified, the line in the data cache is written back to memory. Regardless of its state, the data-cache line is invalidated and the instruction cache performs a burst cycle read from memory.

- *Instruction cache snoop during a data cache miss*—The line in the instruction cache is marked invalid, and the data-cache read or write is performed from memory.

FLUSH#

In response to sampling FLUSH# asserted, the processor writes back any data cache lines that are in the modified state and then marks all lines in the instruction and data caches as invalid.

WBINVD and INVD

These x86 instructions cause all cache lines to be marked as invalid. WBINVD writes back modified lines before marking all cache lines invalid. INVD does not write back modified lines.

Cache-Line Replacement

Replacing lines in the instruction or data cache, according to the line replacement algorithms described in “Cache-Line Fills” on page 176, ensures coherency between main memory and the caches.

Table 31 on page 185 shows all possible cache-line states before and after cache snoop or invalidation operations performed with inquire cycles. This table shows all of the conditions for writethroughs and writebacks to memory.

Table 31. Cache States for Inquiries, Snoops, Invalidation, and Replacement

Type of Operation	Cache State Before Operation	Memory Access	Cache State After Operation		
			MESI State		Writeback Writethrough State
Inquire Cycle	shared or exclusive	-	INV=0	shared	writethrough
			INV=1	invalid	invalid
	modified	burst write (writeback)	INV=0	shared	writethrough
			INV=1	invalid	invalid
Internal Snoop	shared or exclusive	-	invalid		invalid
	modified	burst write (writeback)			
FLUSH# Signal	shared or exclusive	-	invalid		invalid
	modified	burst write (writeback)			
WBINVD Instruction	shared or exclusive	-	invalid		invalid
	modified	burst write (writeback)			
INVD Instruction	-	-	invalid		invalid
Cache-Line Replacement	shared or exclusive	-	See Table 30		
	modified	burst write (writeback)			

Notes:

All writebacks are 32-byte burst write cycles.

- Not applicable or none.

Cache Snooping

Table 32 shows the conditions under which snooping occurs in the AMD-K6 processor and the resources that are snooped.

Table 32. Snoop Action

Type of Event	Type of Access		Snooping Action	
			Instruction Cache	Data Cache
Inquire Cycle	System Logic		yes ¹	yes ¹
Internal Snoop	Instruction Cache	Read Miss	–	yes ²
		Read Hit	–	no
	Data Cache	Read Miss	yes ³	–
		Read Hit	no	–
		Write Miss	yes ³	–
		Write Hit	no	–

Notes:

- The processor's response to an inquire cycle depends on the state of the INV input signal and the state of the cache line as follows:
For the instruction cache, if INV is sampled negated, the line remains invalid or valid, but if INV is sampled asserted, the line is invalidated.
For the data cache, if INV is sampled negated, valid lines remain in or transition to the shared state, a modified data cache line is written back before the line is marked shared (with HITM# asserted), and invalid lines remain invalid. For the data cache, if INV is sampled asserted, the line is marked invalid. Modified lines are written back before invalidation.
- If an internal snoop hits a modified line in the data cache, the line is written back and invalidated. Then the instruction cache performs a burst read from memory.
- If an internal snoop hits a line in the instruction cache, the instruction cache line is invalidated and the data-cache read or write is performed from memory.

– Not applicable.

8.11 Writethrough vs. Writeback Coherency States

The terms *writethrough* and *writeback* apply to two related concepts in a read-write cache like the AMD-K6 processor L1 data cache. The following conditions apply to both the writethrough and writeback modes:

- *Memory Writes*—A relationship exists between external memory writes and their concurrence with cache updates:
 - An external memory write that occurs concurrently with a cache update to the same location is a writethrough. Writethroughs are driven as single cycles on the bus.
 - An external memory write that occurs after the processor has modified a cache line is a writeback. Writebacks are driven as burst cycles on the bus.
- *Coherency State*—A relationship exists between MESI coherency states and writethrough-writeback coherency states of lines in the cache as follows:
 - Shared MESI lines are in the writethrough state.
 - Modified and exclusive MESI lines are in the writeback state.

8.12 A20M# Masking of Cache Accesses

Although the processor samples A20M# as a level-sensitive input on every clock edge, it should only be asserted in Real mode. The CPU applies the A20M# masking to its tags, through which all programs access the caches. Therefore, assertion of A20M# affects all addresses (cache and external memory), including the following:

- Cache-line fills (caused by read misses)
- Cache writethroughs (caused by write misses or write hits to lines in the shared state)

However, A20M# does not mask writebacks or invalidations caused by the following actions:

- Internal snoops
- Inquire cycles
- The FLUSH# signal
- The WBINVD instruction

9 Floating-Point and Multimedia Execution Units

9.1 Floating-Point Execution Unit

The AMD-K6 processor contains an IEEE 754-compatible and 854-compatible floating-point execution unit designed to accelerate the performance of software that utilizes the x86 floating-point instruction set. Floating-point software is typically written to manipulate numbers that are very large or very small, that require a high degree of precision, or that result from complex mathematical operations such as transcendentals. Applications that take advantage of floating-point operations include geometric calculations for graphics acceleration, scientific, statistical, and engineering applications, and business applications that use large amounts of high-precision data.

The high-performance floating-point execution unit contains an adder unit, a multiplier unit, and a divide/square root unit. These low-latency units can execute floating-point instructions in as few as two processor clocks. To increase performance, the processor is designed to simultaneously decode most floating-point instructions with most short-decodeable instructions.

See “Software Environment” on page 21 for a description of the floating-point data types, registers, and instructions.

Handling Floating-Point Exceptions

The AMD-K6 processor provides the following two types of exception handling for floating-point exceptions:

- If the numeric error (NE) bit in CR0 is set to 1, the processor invokes the interrupt 10h handler. In this manner, the floating-point exception is completely handled by software.
- If the NE bit in CR0 is set to 0, the processor requires external logic to generate an interrupt on the INTR signal in order to handle the exception.

External Logic Support of Floating-Point Exceptions

The processor provides the FERR# (Floating-Point Error) and IGNNE# (Ignore Numeric Error) signals to allow the external logic to generate the interrupt in a manner consistent with IBM-compatible PC/AT systems. The assertion of FERR# indicates the occurrence of an unmasked floating-point exception resulting from the execution of a floating-point

instruction. IGNNE# is used by the external hardware to control the effect of an unmasked floating-point exception. Under certain circumstances, if IGNNE# is sampled asserted, the processor ignores the floating-point exception.

Figure 71 illustrates an implementation of external logic for supporting floating-point exceptions. The following example explains the operation of the external logic in Figure 71:

As the result of a floating-point exception, the processor asserts FERR#. The assertion of FERR# and the sampling of IGNNE# negated indicates the processor has stopped instruction execution and is waiting for an interrupt. The assertion of FERR# leads to the assertion of INTR by the interrupt controller. The processor acknowledges the interrupt and jumps to the corresponding interrupt service routine in which an I/O write cycle to address port F0h leads to the assertion of IGNNE#. When IGNNE# is sampled asserted, the processor ignores the floating-point exception and continues instruction execution. When the processor negates FERR#, the external logic negates IGNNE#.

See “FERR# (Floating-Point Error)” on page 96 and “IGNNE# (Ignore Numeric Exception)” on page 100 for more details.

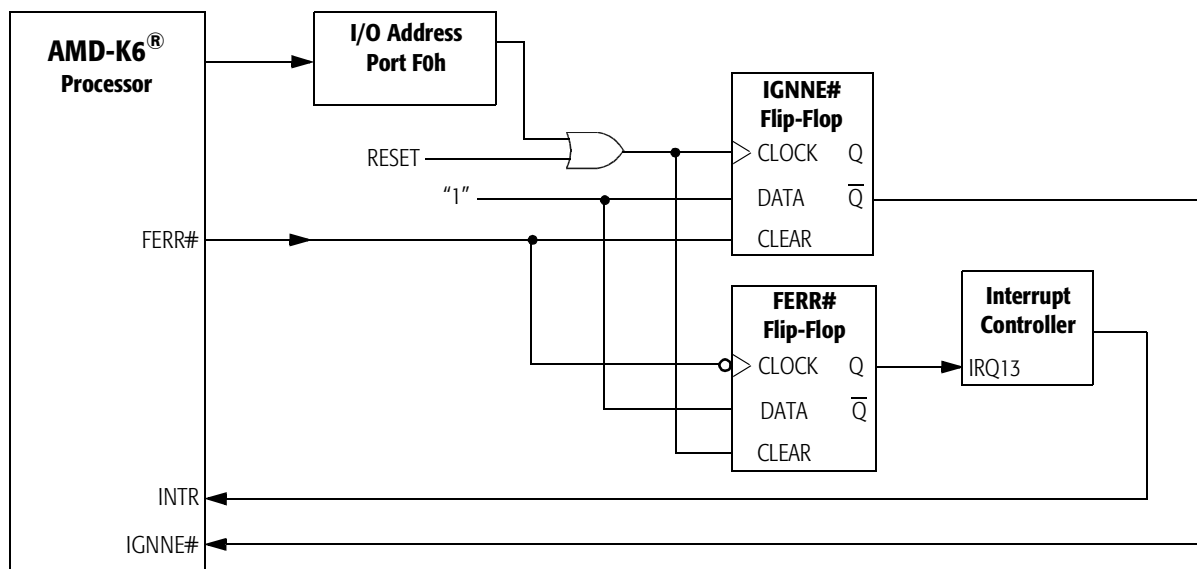

Figure 71. External Logic for Supporting Floating-Point Exceptions

9.2 Multimedia Execution Unit

The multimedia execution unit of the AMD-K6 processor is designed to accelerate the performance of software written using the industry-standard MMX instructions. Applications that can take advantage of the MMX instructions include graphics, video and audio compression and decompression, speech recognition, and telephony applications.

The multimedia execution unit can execute MMX instructions in a single processor clock. To increase performance, the processor is designed to simultaneously decode all MMX instructions with most other instructions.

For more information on MMX instructions, refer to *AMD-K6[®] Processor Multimedia Technology*, order# 20726.

9.3 Floating-Point and MMX[™] Instruction Compatibility

Registers

The eight 64-bit MMX registers are mapped on the floating-point stack. This enables backward compatibility with all existing software. For example, the register saving event that is performed by operating systems during task switching requires no changes to the operating system. The same support provided in an operating system's interrupt 7 handler (Device Not Available) for saving and restoring the floating-point registers also supports saving and restoring the MMX registers.

Exceptions

There are no new exceptions defined for supporting the MMX instructions. All exceptions that occur while decoding or executing an MMX instruction are handled in existing exception handlers without modification.

FERR# and IGNNE#

MMX instructions do not generate floating-point exceptions. However, if an unmasked floating-point exception is pending, the processor asserts FERR# at the instruction boundary of the next floating-point instruction, MMX instruction, or WAIT instruction.

The sampling of IGNNE# asserted only affects processor operation during the execution of an error-sensitive floating-point instruction, MMX instruction, or WAIT instruction when the NE bit in CR0 is set to 0.

10 System Management Mode (SMM)

10.1 Overview

SMM is an alternate operating mode entered by way of a system management interrupt (SMI#) and handled by an interrupt service routine. SMM is designed for system control activities such as power management. These activities appear transparent to conventional operating systems like DOS and Windows. SMM is primarily targeted for use by the Basic Input Output System (BIOS) and specialized low-level device drivers. The code and data for SMM are stored in the SMM memory area, which is isolated from main memory.

The processor enters SMM by the system logic's assertion of the SMI# interrupt and the processor's acknowledgment by the assertion of SMIACT#. At this point the processor saves its state into the SMM memory state-save area and jumps to the SMM service routine. The processor returns from SMM when it executes the RSM (resume) instruction from within the SMM service routine. Subsequently, the processor restores its state from the SMM save area, negates SMIACT#, and resumes execution with the instruction following the point where it entered SMM.

The following sections summarize the SMM state-save area, entry into and exit from SMM, exceptions and interrupts in SMM, memory allocation and addressing in SMM, and the SMI# and SMIACT# signals.

10.2 SMM Operating Mode and Default Register Values

The software environment within SMM has the following characteristics:

- Addressing and operation in Real mode
- 4-Gbyte segment limits
- Default 16-bit operand, address, and stack sizes, although instruction prefixes can override these defaults
- Control transfers that do not override the default operand size truncate the EIP to 16 bits

- Far jumps or calls cannot transfer control to a segment with a base address requiring more than 20 bits, as in Real mode segment-base addressing
- A20M# is masked
- Interrupt vectors use the Real-mode interrupt vector table
- The IF flag in EFLAGS is cleared (INTR not recognized)
- The TF flag in EFLAGS is cleared
- The NMI and INIT interrupts are disabled
- Debug register DR7 is cleared (debug traps disabled)

Figure 72 on page 195 shows the default map of the SMM memory area. It consists of a 64-Kbyte area, between 0003_0000h and 0003_FFFFh, of which the top 32 Kbytes (0003_8000h to 0003_FFFFh) must be populated with RAM. The default code-segment (CS) base address for the area—called the SMM base address—is at 0003_0000h. The top 512 bytes (0003_FE00h to 0003_FFFFh) contain a fill-down SMM state-save area. The default entry point for the SMM service routine is 0003_8000h.

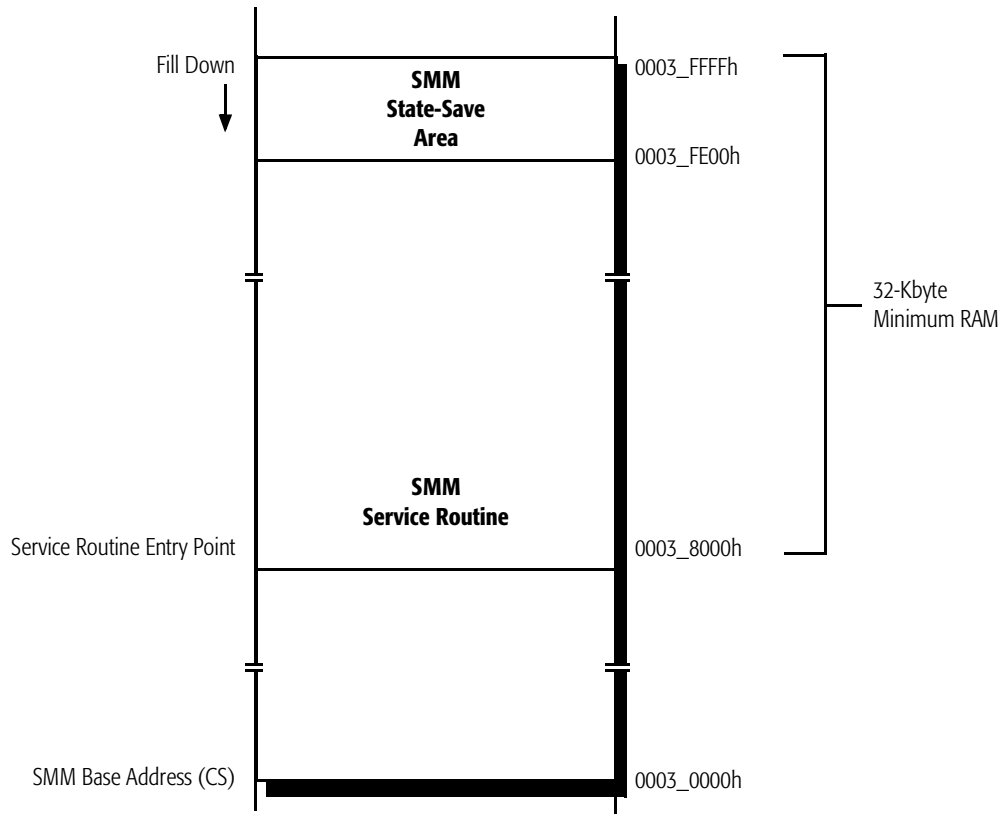

Figure 72. SMM Memory

Table 33 shows the initial state of registers when entering SMM.

Table 33. Initial State of Registers in SMM

Registers	SMM Initial State
General Purpose Registers	unmodified
EFLAGS	0000_0002h
CR0	PE, EM, TS, and PG are cleared (bits 0, 2, 3, and 31). The other bits are unmodified.
DR7	0000_0400h
GDTR, LDTR, IDTR, TSSR, DR6	unmodified
EIP	0000_8000h
CS	0003_0000h
DS, ES, FS, GS, SS	0000_0000h

10.3 SMM State-Save Area

When the processor acknowledges an SMI# interrupt by asserting SMIACT#, it saves its state in a 512-byte SMM state-save area shown in Table 34. The save begins at the top of the SMM memory area (SMM base address + FFFFh) and fills down to SMM base address + FE00h.

Table 34 shows the offsets in the SMM state-save area relative to the SMM base address. The SMM service routine can alter any of the read/write values in the state-save area.

Table 34. SMM State-Save Area Map

Address Offset	Contents Saved
FFFC _h	CR0
FFF8 _h	CR3
FFF4 _h	EFLAGS
FFF0 _h	EIP
FFEC _h	EDI
FFE8 _h	ESI
FFE4 _h	EBP
FFE0 _h	ESP
FFDC _h	EBX
FFD8 _h	EDX
FFD4 _h	ECX
FFD0 _h	EAX
FFC _h	DR6
FFC8 _h	DR7
FFC4 _h	TR
FFC0 _h	LDTR Base
FFB _h	GS
FFB8 _h	FS
FFB4 _h	DS
FFB0 _h	SS
FFA _h	CS
FFA8 _h	ES
Notes:	
— No data dump at that address	
* Only contains information if SMI# is asserted during a valid I/O bus cycle.	

Table 34. SMM State-Save Area Map (continued)

Address Offset	Contents Saved
FFA4h	I/O Trap Dword
FFA0h	—
FF9Ch	I/O Trap EIP*
FF98h	—
FF94h	—
FF90h	IDT Base
FF8Ch	IDT Limit
FF88h	GDT Base
FF84h	GDT Limit
FF80h	TSS Attr
FF7Ch	TSS Base
FF78h	TSS Limit
FF74h	—
FF70h	LDT High
FF6Ch	LDT Low
FF68h	GS Attr
FF64h	GS Base
FF60h	GS Limit
FF5Ch	FS Attr
FF58h	FS Base
FF54h	FS Limit
FF50h	DS Attr
FF4Ch	DS Base
FF48h	DS Limit
FF44h	SS Attr
FF40h	SS Base
FF3Ch	SS Limit
FF38h	CS Attr
FF34h	CS Base
FF30h	CS Limit
FF2Ch	ES Attr
Notes:	
— No data dump at that address	
* Only contains information if SMI# is asserted during a valid I/O bus cycle.	

Table 34. SMM State-Save Area Map (continued)

Address Offset	Contents Saved
FF28h	ES Base
FF24h	ES Limit
FF20h	—
FF1Ch	—
FF18h	—
FF14h	CR2
FF10h	CR4
FF0Ch	I/O restart ESI*
FF08h	I/O restart ECX*
FF04h	I/O restart EDI*
FF02h	HALT Restart Slot
FF00h	I/O Trap Restart Slot
FEFCh	SMM RevID
FEF8h	SMM BASE
FEF7h–FE00h	—
Notes:	
— No data dump at that address	
* Only contains information if SMI# is asserted during a valid I/O bus cycle.	

10.4 SMM Revision Identifier

The SMM revision identifier at offset FEFCh in the SMM state-save area specifies the version of SMM and the extensions that are available on the processor. The SMM revision identifier fields are as follows:

- *Bits 31–18*—Reserved
- *Bit 17*—SMM base address relocation (1 = enabled)
- *Bit 16*—I/O trap restart (1 = enabled)
- *Bits 15–0*—SMM revision level for the AMD-K6 processor = 0002h

Table 35 on page 199 shows the format of the SMM Revision Identifier.

Table 35. SMM Revision Identifier

31–18	17	16	15–0
Reserved	SMM Base Relocation	I/O Trap Extension	SMM Revision Level
0	1	1	0002h

10.5 SMM Base Address

During RESET, the processor sets the base address of the code-segment (CS) for the SMM memory area—the SMM base address—to its default, 0003_0000h. The SMM base address at offset FEF8h in the SMM state-save area can be changed by the SMM service routine to any address that is aligned to a 32-Kbyte boundary. (Locations not aligned to a 32-Kbyte boundary cause the processor to enter the Shutdown state when executing the RSM instruction.)

In some operating environments it may be desirable to relocate the 64-Kbyte SMM memory area to a high memory area in order to provide more low memory for legacy software. During system initialization, the base of the 64-Kbyte SMM memory area is relocated by the BIOS. To relocate the SMM base address, the system enters the SMM handler at the default address. This handler changes the SMM base address location in the SMM state-save area, copies the SMM handler to the new location, and exits SMM.

The next time SMM is entered, the processor saves its state at the new base address. This new address is used for every SMM entry until the SMM base address in the SMM state-save area is changed or a hardware reset occurs.

10.6 Halt Restart Slot

During entry into SMM, the halt restart slot at offset FF02h in the SMM state-save area indicates if SMM was entered from the Halt state. Before returning from SMM, the halt restart slot (offset FF02h) can be written to by the SMM service routine to specify whether the return from SMM takes the processor back to the Halt state or to the next instruction after the HLT instruction.

Upon entry into SMM, the halt restart slot is defined as follows:

- *Bits 15–1*—Reserved
- *Bit 0*—Point of entry to SMM:
 - 1 = entered from Halt state
 - 0 = not entered from Halt state

After entry into the SMI handler and before returning from SMM, the halt restart slot can be written using the following definition:

- *Bits 15–1*—Reserved
- *Bit 0*—Point of return when exiting from SMM:
 - 1 = return to Halt state
 - 0 = return to next instruction after the HLT instruction

If the return from SMM takes the processor back to the Halt state, the HLT instruction is not re-executed, but the Halt special bus cycle is driven on the bus after the return.

10.7 I/O Trap Dword

If the assertion of SMI# is recognized during the execution of an I/O instruction, the I/O trap dword at offset FFA4h in the SMM state-save area contains information about the instruction. The fields of the I/O trap dword are configured as follows:

- *Bits 31–16*—I/O port address
- *Bits 15–4*—Reserved
- *Bit 3*—REP (repeat) string operation (1 = REP string, 0 = not a REP string)
- *Bit 2*—I/O string operation (1 = I/O string, 0 = not an I/O string)
- *Bit 1*—Valid I/O instruction (1 = valid, 0 = invalid)
- *Bit 0*—Input or output instruction (1 = INx, 0 = OUTx)

Table 36 shows the format of the I/O trap dword.

Table 36. I/O Trap Dword Configuration

31–16	15–4	3	2	1	0
I/O Port Address	Reserved	REP String Operation	I/O String Operation	Valid I/O Instruction	Input or Output

The I/O trap dword is related to the I/O trap restart slot (see “I/O Trap Restart Slot”). If bit 1 of the I/O trap dword is set by the processor, it means that SMI# was asserted during the execution of an I/O instruction. The SMI handler tests bit 1 to see if there is a valid I/O instruction trapped. If the I/O instruction is valid, the SMI handler is required to ensure the I/O trap restart slot is set properly. The I/O trap restart slot informs the CPU whether it should re-execute the I/O instruction after the RSM or execute the instruction following the trapped I/O instruction.

Note: If SMI# is sampled asserted during an I/O bus cycle a minimum of three clock edges before BRDY# is sampled asserted, the associated I/O instruction is guaranteed to be trapped by the SMI handler.

10.8 I/O Trap Restart Slot

The I/O trap restart slot at offset FF00h in the SMM state-save area specifies whether the trapped I/O instruction should be re-executed on return from SMM. This slot in the state-save area is called the *I/O instruction restart* function. Re-executing a trapped I/O instruction is useful, for example, if an I/O write occurs to a disk that is powered down. The system logic monitoring such an access can assert SMI#. Then the SMM service routine would query the system logic, detect a failed I/O write, take action to power-up the I/O device, enable the I/O trap restart slot feature, and return from SMM.

The fields of the I/O trap restart slot are defined as follows:

- *Bits 31–16*—Reserved
- *Bits 15–0*—I/O instruction restart on return from SMM:
 - 0000h = execute the next instruction after the trapped I/O instruction
 - 00FFh = re-execute the trapped I/O instruction

Table 37 shows the format of the I/O trap restart slot.

Table 37. I/O Trap Restart Slot

31–16	15–0
Reserved	I/O Instruction restart on return from SMM: <ul style="list-style-type: none"> ■ 0000h = execute the next instruction after the trapped I/O ■ 00FFh = re-execute the trapped I/O instruction

The processor initializes the I/O trap restart slot to 0000h upon entry into SMM. If SMM was entered due to a trapped I/O instruction, the processor indicates the validity of the I/O instruction by setting or clearing bit 1 of the I/O trap dword at offset FFA4h in the SMM state-save area. The SMM service routine should test bit 1 of the I/O trap dword to determine if a valid I/O instruction was being executed when entering SMM and before writing the I/O trap restart slot. If the I/O instruction is valid, the SMM service routine can safely rewrite the I/O trap restart slot with the value 00FFh, which causes the processor to re-execute the trapped I/O instruction when the RSM instruction is executed. If the I/O instruction is invalid, writing the I/O trap restart slot has undefined results.

If a second SMI# is asserted and a valid I/O instruction was trapped by the first SMM handler, the CPU services the second SMI# prior to re-executing the trapped I/O instruction. The second entry into SMM never has bit 1 of the I/O trap dword set, and the second SMM service routine must not rewrite the I/O trap restart slot.

During a simultaneous SMI# I/O instruction trap and debug breakpoint trap, the AMD-K6 processor first responds to the SMI# and postpones recognizing the debug exception until after returning from SMM via the RSM instruction. If the debug registers DR3–DR0 are used while in SMM, they must be saved and restored by the SMM handler. The processor automatically saves and restores DR7–DR6. If the I/O trap restart slot in the SMM state-save area contains the value 00FFh when the RSM instruction is executed, the debug trap does not occur until after the I/O instruction is re-executed.

10.9 Exceptions, Interrupts, and Debug in SMM

During an SMI# I/O trap, the exception/interrupt priority of the AMD-K6 processor changes from its normal priority. The normal priority places the debug traps at a priority higher than the sampling of the FLUSH# or SMI# signals. However, during an SMI# I/O trap, the sampling of the FLUSH# or SMI# signals takes precedence over debug traps.

The processor recognizes the assertion of NMI within SMM immediately after the completion of an IRET instruction. Once NMI is recognized within SMM, NMI recognition remains enabled until SMM is exited, at which point NMI masking is restored to the state it was in before entering SMM.

11 Test and Debug

The AMD-K6 processor implements various test and debug modes to enable the functional and manufacturing testing of systems and boards that use the processor. In addition, the debug features of the processor allow designers to debug the instruction execution of software components. This chapter describes the following test and debug features:

- *Built-In Self-Test (BIST)*—The BIST, which is invoked after the falling transition of RESET, runs internal tests that exercise most on-chip RAM structures.
- *Tri-State Test Mode*—A test mode that causes the processor to float its output and bidirectional pins.
- *Boundary-Scan Test Access Port (TAP)*—The Joint Test Action Group (JTAG) test access function defined by the *IEEE Standard Test Access Port and Boundary-Scan Architecture (IEEE 1149.1-1990)* specification.
- *Level-One (L1) Cache Inhibit*—A feature that disables the processor's internal L1 instruction and data caches.
- *Debug Support*—Consists of all x86-compatible software debug features, including the debug extensions.

11.1 Built-In Self-Test (BIST)

Following the falling transition of RESET, the processor unconditionally runs its BIST. The internal resources tested during BIST include the following:

- L1 instruction and data caches
- Instruction and Data Translation Lookaside Buffers (TLBs)

The contents of the EAX general-purpose register after the completion of reset indicate if the BIST was successful. If EAX contains 0000_0000h, then BIST was successful. If EAX is non-zero, the BIST failed. Following the completion of the BIST, the processor jumps to address FFFF_FFF0h to start instruction execution, regardless of the outcome of the BIST.

The BIST takes approximately 295,000 processor clocks to complete.

11.2 Tri-State Test Mode

The Tri-State Test mode causes the processor to float its output and bidirectional pins, which is useful for board-level manufacturing testing. In this mode, the processor is electrically isolated from other components on a system board, allowing automated test equipment (ATE) to test components that drive the same signals as those the processor floats.

If the FLUSH# signal is sampled Low during the falling transition of RESET, the processor enters the Tri-State Test mode. (See “FLUSH# (Cache Flush)” on page 97 for the specific sampling requirements.) The signals floated in the Tri-State Test mode are as follows:

- | | | |
|------------|-----------|-----------|
| ■ A[31:3] | ■ D/C# | ■ M/IO# |
| ■ ADS# | ■ D[63:0] | ■ PCD |
| ■ ADSC# | ■ DP[7:0] | ■ PCHK# |
| ■ AP | ■ FERR# | ■ PWT |
| ■ APCHK# | ■ HIT# | ■ SCYC |
| ■ BE[7:0]# | ■ HITM# | ■ SMIACT# |
| ■ BREQ | ■ HLDA | ■ W/R# |
| ■ CACHE# | ■ LOCK# | |

The VCC2DET and TDO signals are the only outputs not floated in the Tri-State Test mode. VCC2DET must remain Low to ensure the system continues to supply the specified processor core voltage to the V_{CC2} pins. TDO is never floated because the Boundary-Scan Test Access Port must remain enabled at all times, including during the Tri-State Test mode.

The Tri-State Test mode is exited when the processor samples RESET asserted.

11.3 Boundary-Scan Test Access Port (TAP)

The boundary-scan Test Access Port (TAP) is an IEEE standard that defines synchronous scanning test methods for complex logic circuits, such as boards containing a processor. The AMD-K6 processor supports the TAP standard defined in the *IEEE Standard Test Access Port and Boundary-Scan Architecture (IEEE 1149.1-1990)* specification.

Boundary scan testing uses a shift register consisting of the serial interconnection of boundary-scan cells that correspond to each I/O buffer of the processor. This non-inverting register chain, called a Boundary Scan Register (BSR), can be used to capture the state of every processor pin and to drive every processor output and bidirectional pin to a known state.

Each BSR of every component on a board that implements the boundary-scan architecture can be serially interconnected to enable component interconnect testing.

Test Access Port

The TAP consists of the following:

- *Test Access Port (TAP) Controller*—The TAP controller is a synchronous, finite state machine that uses the TMS and TDI input signals to control a sequence of test operations. See “TAP Controller State Machine” on page 212 for a list of TAP states and their definition.
- *Instruction Register (IR)*—The IR contains the instructions that select the test operation to be performed and the Test Data Register (TDR) to be selected. See “TAP Registers” on page 206 for more details on the IR.
- *Test Data Registers (TDR)*—The three TDRs are used to process the test data. Each TDR is selected by an instruction in the Instruction Register (IR). See “TAP Registers” on page 206 for a list of these registers and their functions.

TAP Signals

The test signals associated with the TAP controller are as follows:

- *TCK*—The Test Clock for all TAP operations. The rising edge of TCK is used for sampling TAP signals, and the falling edge of TCK is used for asserting TAP signals. The state of the TMS signal sampled on the rising edge of TCK causes

the state transitions of the TAP controller to occur. TCK can be stopped in the logic 0 or 1 state.

- *TDI*—The Test Data Input represents the input to the most significant bit of all TAP registers, including the IR and all test data registers. Test data and instructions are serially shifted by one bit into their respective registers on the rising edge of TCK.
- *TDO*—The Test Data Output represents the output of the least significant bit of all TAP registers, including the IR and all test data registers. Test data and instructions are serially shifted by one bit out of their respective registers on the falling edge of TCK.
- *TMS*—The Test Mode Select input specifies the test function and sequence of state changes for boundary-scan testing. If TMS is sampled High for five or more consecutive clocks, the TAP controller enters its reset state.
- *TRST#*—The Test Reset signal is an asynchronous reset that unconditionally causes the TAP controller to enter its reset state.

Refer to “Electrical Data” on page 233 and “Signal Switching Characteristics” on page 241 to obtain the electrical specifications of the test signals.

TAP Registers

The AMD-K6 processor provides an Instruction Register (IR) and three Test Data Registers (TDR) to support the boundary-scan architecture. The IR and one of the TDRs—the Boundary-Scan Register (BSR)—consist of a shift register and an output register. The shift register is loaded in parallel in the Capture states. (See “TAP Controller State Machine” on page 212 for a description of the TAP controller states.) In addition, the shift register is loaded and shifted serially in the Shift states. The output register is loaded in parallel from its corresponding shift register in the Update states.

Instruction Register (IR). The IR is a 5-bit register, without parity, that determines which instruction to run and which test data register to select. When the TAP controller enters the Capture-IR state, the processor loads the following bits into the IR shift register:

- *01b*—Loaded into the two least significant bits, as specified by the IEEE 1149.1 standard
- *000b*—Loaded into the three most significant bits

Loading 00001b into the IR shift register during the Capture-IR state results in loading the SAMPLE/PRELOAD instruction.

For each entry into the Shift-IR state, the IR shift register is serially shifted by one bit toward the TDO pin. During the shift, the most significant bit of the IR shift register is loaded from the TDI pin.

The IR output register is loaded from the IR shift register in the Update-IR state, and the current instruction is defined by the IR output register. See “TAP Instructions” on page 211 for a list and definition of the instructions supported by the AMD-K6.

Boundary Scan Register (BSR). The BSR is a Test Data Register consisting of the interconnection of 152 boundary-scan cells. Each output and bidirectional pin of the processor requires a two-bit cell, where one bit corresponds to the pin and the other bit is the output enable for the pin. When a 0 is shifted into the enable bit of a cell, the corresponding pin is floated, and when a 1 is shifted into the enable bit, the pin is driven valid. Each input pin requires a one-bit cell that corresponds to the pin. The last cell of the BSR is reserved and does not correspond to any processor pin.

The total number of bits that comprise the BSR is 281. Table 38 on page 209 lists the order of these bits, where TDI is the input to bit 280, and TDO is driven from the output of bit 0. The entries listed as *pin_E* (where *pin* is an output or bidirectional signal) are the enable bits.

If the BSR is the register selected by the current instruction and the TAP controller is in the Capture-DR state, the processor loads the BSR shift register as follows:

- If the current instruction is SAMPLE/PRELOAD, then the current state of each input, output, and bidirectional pin is loaded. A bidirectional pin is treated as an output if its enable bit equals 1, and it is treated as an input if its enable bit equals 0.
- If the current instruction is EXTEST, then the current state of each input pin is loaded. A bidirectional pin is treated as an input, regardless of the state of its enable.

While in the Shift-DR state, the BSR shift register is serially shifted toward the TDO pin. During the shift, bit 280 of the BSR is loaded from the TDI pin.

The BSR output register is loaded with the contents of the BSR shift register in the Update-DR state. If the current instruction is EXTEST, the processor's output pins, as well as those bidirectional pins that are enabled as outputs, are driven with their corresponding values from the BSR output register.

Table 38. Boundary Scan Bit Definitions

Bit	Pin/Enable	Bit	Pin/Enable	Bit	Pin/Enable	Bit	Pin/Enable	Bit	Pin/Enable	Bit	Pin/Enable
280	D35_E	247	D21	214	D4_E	181	A3	148	A20	115	A16
279	D35	246	D18_E	213	D4	180	A31_E	147	A13_E	114	FERR_E
278	D29_E	245	D18	212	DP0_E	179	A31	146	A13	113	FERR#
277	D29	244	D19_E	211	DP0	178	A21_E	145	DP7_E	112	HIT_E
276	D33_E	243	D19	210	HOLD	177	A21	144	DP7	111	HIT#
275	D33	242	D16_E	209	BOFF#	176	A30_E	143	BE6_E	110	BE7_E
274	D27_E	241	D16	208	AHOLD	175	A30	142	BE6#	109	BE7#
273	D27	240	D17_E	207	STPCLK#	174	A7_E	141	A12_E	108	NA#
272	DP3_E	239	D17	206	INIT	173	A7	140	A12	107	ADSC_E
271	DP3	238	D15_E	205	IGNNE#	172	A24_E	139	CLK	106	ADSC#
270	D25_E	237	D15	204	BF1	171	A24	138	BE4_E	105	BE5_E
269	D25	236	DP1_E	203	BF2	170	A18_E	137	BE4#	104	BE5#
268	D0_E	235	DP1	202	RESET	169	A18	136	A10_E	103	WB/WT#
267	D0	234	D13_E	201	BF0	168	A5_E	135	A10	102	PWT_E
266	D30_E	233	D13	200	FLUSH#	167	A5	134	D63_E	101	PWT
265	D30	232	D6_E	199	INTR	166	A22_E	133	D63	100	BE3_E
264	DP2_E	231	D6	198	NMI	165	A22	132	BE2_E	99	BE3#
263	DP2	230	D14_E	197	SMI#	164	EADS#	131	BE2#	98	BREQ_E
262	D2_E	229	D14	196	A25_E	163	A4_E	130	A15_E	97	BREQ
261	D2	228	D11_E	195	A25	162	A4	129	A15	96	PCD_E
260	D28_E	227	D11	194	A23_E	161	HITM_E	128	BRDY#	95	PCD
259	D28	226	D1_E	193	A23	160	HITM#	127	BE1_E	94	WR_E
258	D24_E	225	D1	192	A26_E	159	A9_E	126	BE1#	93	W/R#
257	D24	224	D12_E	191	A26	158	A9	125	A14_E	92	SMIACT_E
256	D26_E	223	D12	190	A29_E	157	SCYC_E	124	A14	91	SMIACT#
255	D26	222	D10_E	189	A29	156	SCYC	123	BRDYC#	90	EWBE#
254	D22_E	221	D10	188	A28_E	155	A8_E	122	BE0_E	89	DC_E
253	D22	220	D7_E	187	A28	154	A8	121	BE0#	88	D/C#
252	D23_E	219	D7	186	A27_E	153	A19_E	120	A17_E	87	APCHK_E
251	D23	218	D8_E	185	A27	152	A19	119	A17	86	APCHK#
250	D20_E	217	D8	184	A11_E	151	A6_E	118	KEN#	85	CACHE_E
249	D20	216	D9_E	183	A11	150	A6	117	A20M#	84	CACHE#
248	D21_E	215	D9	182	A3_E	149	A20_E	116	A16_E	83	ADS_E

Table 38. Boundary Scan Bit Definitions (continued)

Bit	Pin/Enable	Bit	Pin/Enable	Bit	Pin/Enable	Bit	Pin/Enable	Bit	Pin/Enable	Bit	Pin/Enable
82	ADS#	68	DP6_E	54	D53_E	40	D43_E	26	D38_E	12	D3_E
81	AP_E	67	DP6	53	D53	39	D43	25	D38	11	D3
80	AP	66	D54_E	52	D47_E	38	D62_E	24	D58_E	10	D39_E
79	INV	65	D54	51	D47	37	D62	23	D58	9	D39
78	HLDA_E	64	D50_E	50	D59_E	36	D49_E	22	D42_E	8	D32_E
77	HLDA	63	D50	49	D59	35	D49	21	D42	7	D32
76	PCHK_E	62	D56_E	48	D51_E	34	DP4_E	20	D36_E	6	D5_E
75	PCHK#	61	D56	47	D51	33	DP4	19	D36	5	D5
74	LOCK_E	60	D55_E	46	D45_E	32	D46_E	18	D60_E	4	D37_E
73	LOCK#	59	D55	45	D45	31	D46	17	D60	3	D37
72	MIO_E	58	D48_E	44	D61_E	30	D41_E	16	D40_E	2	D31_E
71	M/IO#	57	D48	43	D61	29	D41	15	D40	1	D31
70	D52_E	56	D57_E	42	DP5_E	28	D44_E	14	D34_E	0	Reserved
69	D52	55	D57	41	DP5	27	D44	13	D34		

Device Identification Register (DIR). The DIR is a 32-bit Test Data Register selected during the execution of the IDCODE instruction. The fields of the DIR and their values are shown in Table 39 and are defined as follows:

- *Version Code*—This 4-bit field is incremented by AMD manufacturing for each major revision of silicon.
- *Part Number*—This 16-bit field identifies the specific processor model.
- *Manufacturer*—This 11-bit field identifies the manufacturer of the component (AMD).
- *LSB*—The least significant bit (LSB) of the DIR is always set to 1, as specified by the IEEE 1149.1 standard.

Table 39. Device Identification Register

Version Code (Bits 31–28)	Part Number (Bits 27–12)	Manufacturer (Bits 11–1)	LSB (Bit 0)
Xh	0560h	0000000001b	1b

Bypass Register (BR). The BR is a Test Data Register consisting of a 1-bit shift register that provides the shortest path between TDI and TDO. When the processor is not involved in a test operation, the BR can be selected by an instruction to allow the transfer of test data through the processor without having to serially scan the test data through the BSR. This functionality preserves the state of the BSR and significantly reduces test time.

The BR register is selected by the BYPASS and HIGHZ instructions as well as by any instructions not supported by the AMD-K6.

TAP Instructions

The processor supports the three instructions required by the IEEE 1149.1 standard—EXTEST, SAMPLE/PRELOAD, and BYPASS—as well as two additional optional instructions—IDCODE and HIGHZ.

Table 40 shows the complete set of TAP instructions supported by the processor along with the 5-bit Instruction Register encoding and the register selected by each instruction.

Table 40. Supported Tap Instructions

Instruction	Encoding	Register	Description
EXTEST ¹	00000b	BSR	Sample inputs and drive outputs
SAMPLE / PRELOAD	00001b	BSR	Sample inputs and outputs, then load the BSR
IDCODE	00010b	DIR	Read DIR
HIGHZ	00011b	BR	Float outputs and bidirectional pins
BYPASS ²	00100b–11110b	BR	Undefined instruction, execute the BYPASS instruction
BYPASS ³	11111b	BR	Connect TDI to TDO to bypass the BSR

Notes:

- Following the execution of the EXTEST instruction, the processor must be reset in order to return to normal, non-test operation.
- These instruction encodings are undefined on the AMD-K6 processor and default to the BYPASS instruction.
- Because the TDI input contains an internal pullup, the BYPASS instruction is executed if the TDI input is not connected or open during an instruction scan operation. The BYPASS instruction does not affect the normal operational state of the processor.

EXTEST. When the EXTEST instruction is executed, the processor loads the BSR shift register with the current state of the input and bidirectional pins in the Capture-DR state and drives the output and bidirectional pins with the corresponding values from the BSR output register in the Update-DR state.

SAMPLE/PRELOAD. The SAMPLE/PRELOAD instruction performs two functions. These functions are as follows:

- During the Capture-DR state, the processor loads the BSR shift register with the current state of every input, output, and bidirectional pin.
- During the Update-DR state, the BSR output register is loaded from the BSR shift register in preparation for the next EXTEST instruction.

The SAMPLE/PRELOAD instruction does not affect the normal operational state of the processor.

BYPASS. The BYPASS instruction selects the BR register, which reduces the boundary-scan length through the processor from 281 to one (TDI to BR to TDO). The BYPASS instruction does not affect the normal operational state of the processor.

IDCODE. The IDCODE instruction selects the DIR register, allowing the device identification code to be shifted out of the processor. This instruction is loaded into the IR when the TAP controller is reset. The IDCODE instruction does not affect the normal operational state of the processor.

HIGHZ. The HIGHZ instruction forces all output and bidirectional pins to be floated. During this instruction, the BR is selected and the normal operational state of the processor is not affected.

TAP Controller State Machine

The TAP controller state diagram is shown in Figure 73 on page 213. State transitions occur on the rising edge of TCK. The logic 0 or 1 next to the states represents the value of the TMS signal sampled by the processor on the rising edge of TCK.

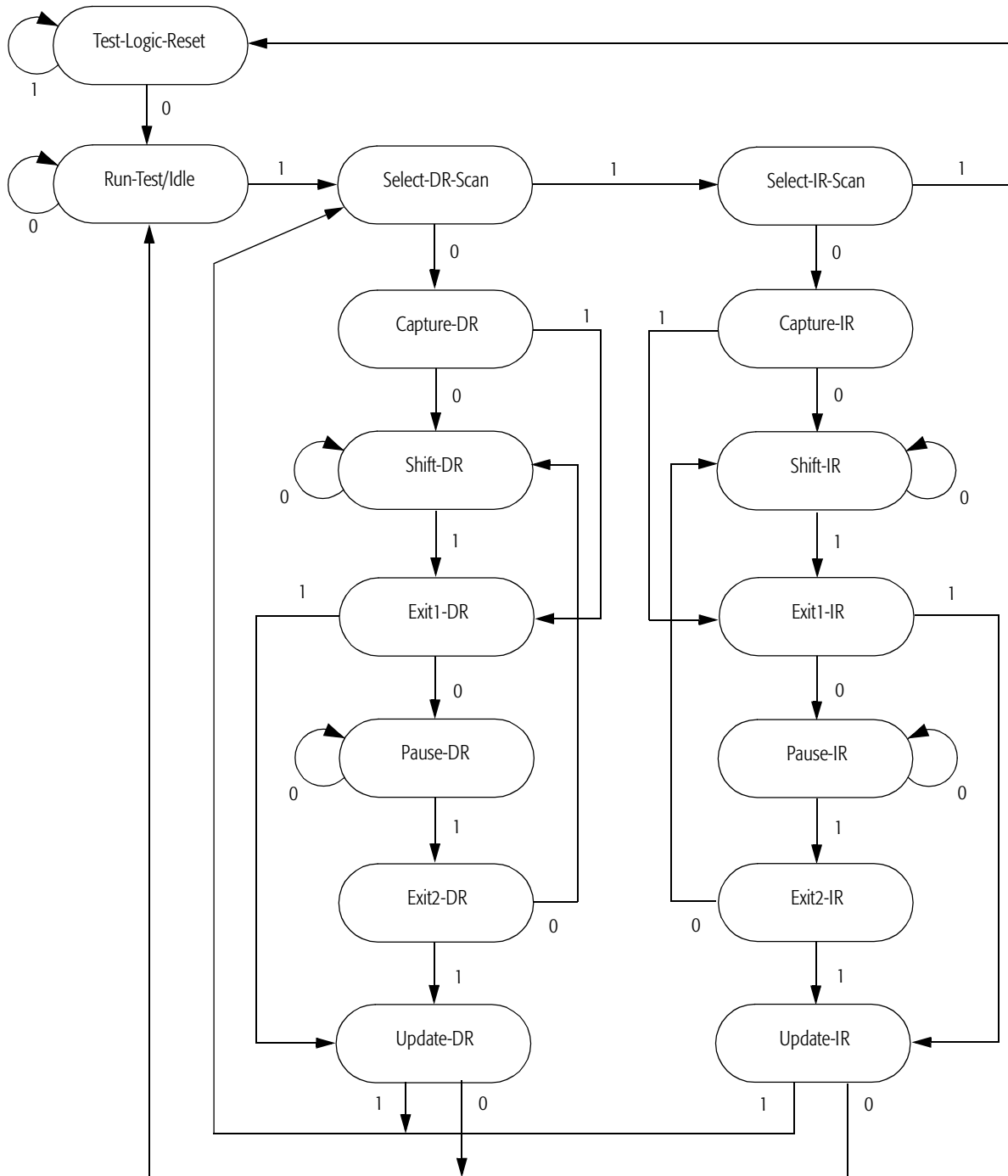

IEEE Std 1149.1-1990, Copyright © 1990. IEEE. All rights reserved

Figure 73. TAP State Diagram

The states of the TAP controller are described as follows:

Test-Logic-Reset. This state represents the initial reset state of the TAP controller and is entered when the processor samples RESET asserted, when TRST# is asynchronously asserted, and when TMS is sampled High for five or more consecutive clocks. In addition, this state can be entered from the Select-IR-Scan state. The IR is initialized with the IDCODE instruction, and the processor's normal operation is not affected in this state.

Capture-DR. During the SAMPLE/PRELOAD instruction, the processor loads the BSR shift register with the current state of every input, output, and bidirectional pin. During the EXTEST instruction, the processor loads the BSR shift register with the current state of every input and bidirectional pin.

Capture-IR. When the TAP controller enters the Capture-IR state, the processor loads 01b into the two least significant bits of the IR shift register and loads 000b into the three most significant bits of the IR shift register.

Shift-DR. While in the Shift-DR state, the selected TDR shift register is serially shifted toward the TDO pin. During the shift, the most significant bit of the TDR is loaded from the TDI pin.

Shift-IR. While in the Shift-IR state, the IR shift register is serially shifted toward the TDO pin. During the shift, the most significant bit of the IR is loaded from the TDI pin.

Update-DR. During the SAMPLE/PRELOAD instruction, the BSR output register is loaded with the contents of the BSR shift register. During the EXTEST instruction, the output pins, as well as those bidirectional pins defined as outputs, are driven with their corresponding values from the BSR output register.

Update-IR. In this state, the IR output register is loaded from the IR shift register, and the current instruction is defined by the IR output register.

The following states have no effect on the normal or test operation of the processor other than as shown in Figure 73 on page 213:

- Run-Test/Idle—This state is an idle state between scan operations.
- Select-DR-Scan—This is the initial state of the test data register state transitions.
- Select-IR-Scan—This is the initial state of the Instruction Register state transitions.
- Exit1-DR—This state is entered to terminate the shifting process and enter the Update-DR state.
- Exit1-IR—This state is entered to terminate the shifting process and enter the Update-IR state.
- Pause-DR—This state is entered to temporarily stop the shifting process of a Test Data Register.
- Pause-IR—This state is entered to temporarily stop the shifting process of the Instruction Register.
- Exit2-DR—This state is entered in order to either terminate the shifting process and enter the Update-DR state or to resume shifting following the exit from the Pause-DR state.
- Exit2-IR—This state is entered in order to either terminate the shifting process and enter the Update-IR state or to resume shifting following the exit from the Pause-IR state.

11.4 L1 Cache Inhibit

Purpose

The AMD-K6 processor provides a means for inhibiting the normal operation of its L1 instruction and data caches while still supporting an external Level-2 (L2) cache. This capability allows system designers to disable the L1 cache during the testing and debug of an L2 cache.

If the Cache Inhibit bit (bit 3) of Test Register 12 (TR12) is set to 0, the processor's L1 cache is enabled and operates as described in "Cache Organization" on page 171. If the Cache Inhibit bit is set to 1, the L1 cache is disabled and no new cache lines are allocated. Even though new allocations do not occur, valid L1 cache lines remain valid and are read by the processor when a requested address hits a cache line. In addition, the processor continues to support inquire cycles initiated by the

system logic, including the execution of writeback cycles when a modified cache line is hit.

While the L1 is inhibited, the processor continues to drive the PCD output signal appropriately, which system logic can use to control external L2 caching.

In order to completely disable the L1 cache so no valid lines exist in the cache, the Cache Inhibit bit must be set to 1 and the cache must be flushed in one of the following ways:

- By asserting the FLUSH# input signal
- By executing the WBINVD instruction
- By executing the INVD instruction (modified cache lines are not written back to memory)

11.5 Debug

The AMD-K6 processor implements the standard x86 debug functions, registers, and exceptions. In addition, the processor supports the I/O breakpoint debug extension. The debug feature assists programmers and system designers during software execution tracing by generating exceptions when one or more events occur during processor execution. The exception handler, or debugger, can be written to perform various tasks, such as displaying the conditions that caused the breakpoint to occur, displaying and modifying register or memory contents, or single-stepping through program execution.

The following sections describe the debug registers and the various types of breakpoints and exceptions that the processor supports.

Debug Registers

Figures 74 through 77 show the 32-bit debug registers supported by the processor.

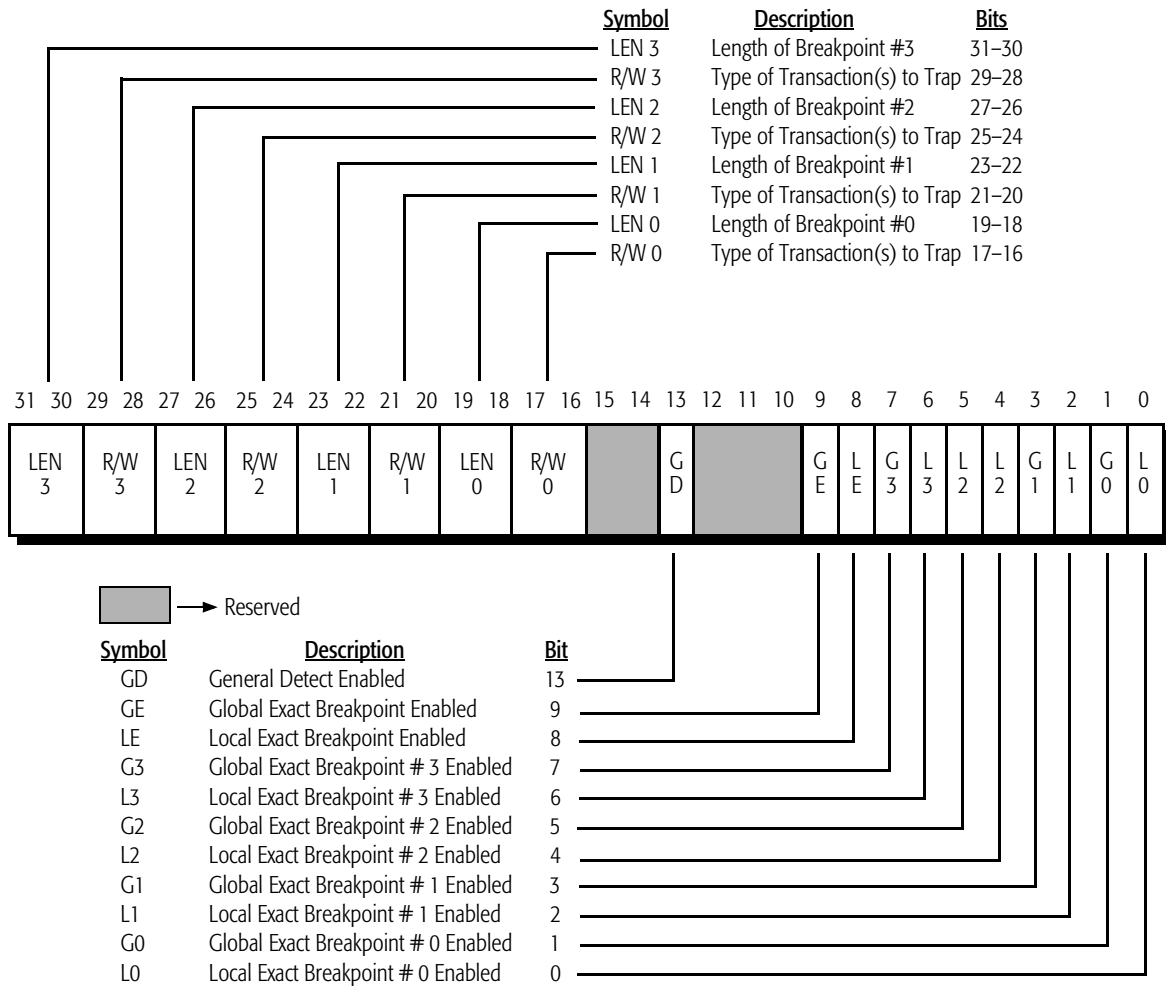

Figure 74. Debug Register DR7

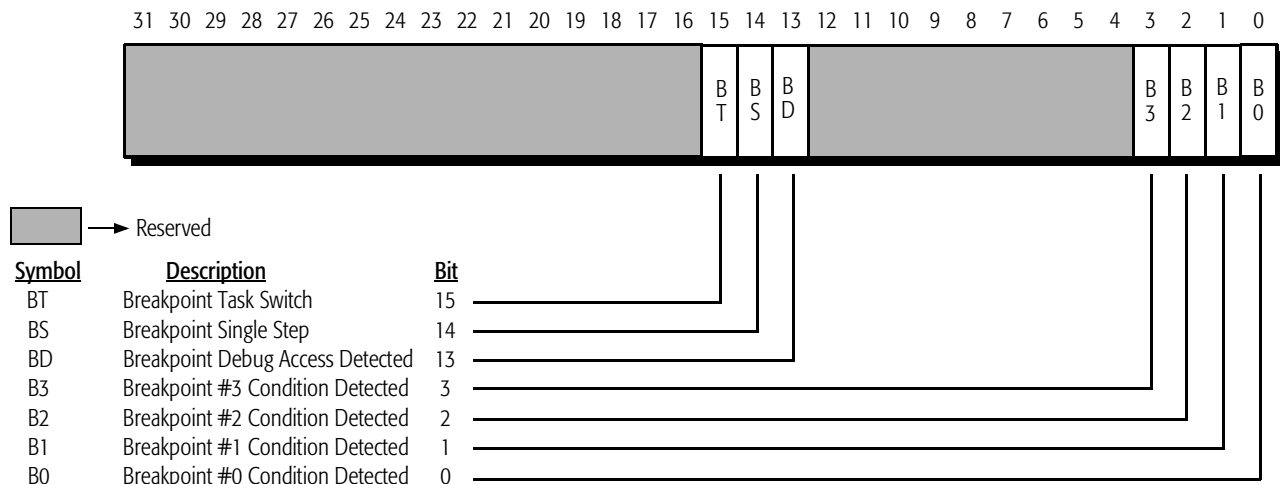
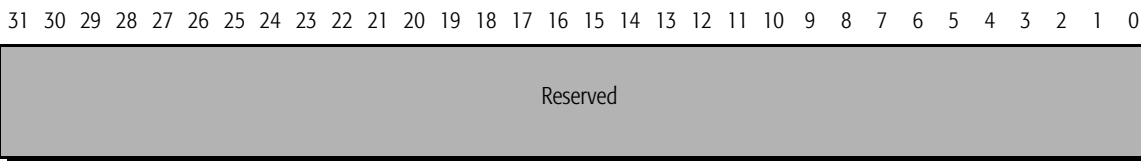

Figure 75. Debug Register DR6

DR5



DR4

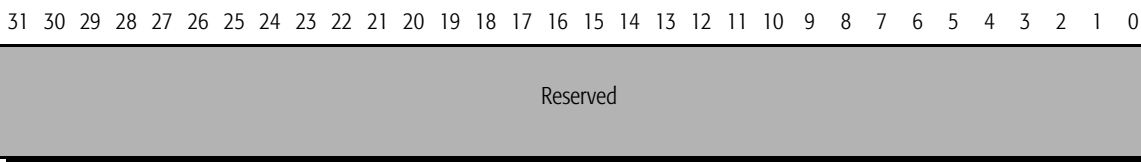

Figure 76. Debug Registers DR5 and DR4

DR3

31 30 29 28 27 26 25 24 23 22 21 20 19 18 17 16 15 14 13 12 11 10 9 8 7 6 5 4 3 2 1 0

Breakpoint 3 32-bit Linear Address

DR2

31 30 29 28 27 26 25 24 23 22 21 20 19 18 17 16 15 14 13 12 11 10 9 8 7 6 5 4 3 2 1 0

Breakpoint 2 32-bit Linear Address

DR1

31 30 29 28 27 26 25 24 23 22 21 20 19 18 17 16 15 14 13 12 11 10 9 8 7 6 5 4 3 2 1 0

Breakpoint 1 32-bit Linear Address

DR0

31 30 29 28 27 26 25 24 23 22 21 20 19 18 17 16 15 14 13 12 11 10 9 8 7 6 5 4 3 2 1 0

Breakpoint 0 32-bit Linear Address

Figure 77. Debug Registers DR3, DR2, DR1, and DR0

DR3–DR0. The processor allows the setting of up to four breakpoints. DR3–DR0 contain the linear addresses for breakpoint 3 through breakpoint 0, respectively, and are compared to the linear addresses of processor cycles to determine if a breakpoint occurs. Debug register DR7 defines the specific type of cycle that must occur in order for the breakpoint to occur.

DR5–DR4. When debugging extensions are disabled (bit 3 of CR4 is set to 0), the DR5 and DR4 registers are mapped to DR7 and DR6, respectively, in order to be software compatible with previous generations of x86 processors. When debugging

extensions are enabled (bit 3 of CR4 is set to 1), any attempt to load DR5 or DR4 results in an undefined opcode exception. Likewise, any attempt to store DR5 or DR4 also results in an undefined opcode exception.

DR6. If a breakpoint is enabled in DR7, and the breakpoint conditions as defined in DR7 occur, then the corresponding B-bit (B3–B0) in DR6 is set to 1. In addition, any other breakpoints defined using these particular breakpoint conditions are reported by the processor by setting the appropriate B-bits in DR6, regardless of whether these breakpoints are enabled or disabled. However, if a breakpoint is not enabled, a debug exception does not occur for that breakpoint.

If the processor decodes an instruction that writes or reads DR7 through DR0, the BD bit (bit 13) in DR6 is set to 1 (if enabled in DR7) and the processor generates a debug exception. This operation allows control to pass to the debugger prior to debug register access by software.

If the Trap Flag (bit 8) of the EFLAGS register is set to 1, the processor generates a debug exception after the successful execution of every instruction (single-step operation) and sets the BS bit (bit 14) in DR6 to indicate the source of the exception.

When the processor switches to a new task and the debug trap bit (T-bit) in the corresponding Task State Segment (TSS) is set to 1, the processor sets the BT bit (bit 15) in DR6 and generates a debug exception.

DR7. When set to 1, L3–L0 locally enable breakpoints 3 through 0, respectively. L3–L0 are set to 0 whenever the processor executes a task switch. Setting L3–L0 to 0 disables the breakpoints and ensures that these particular debug exceptions are only generated for a specific task.

When set to 1, G3–G0 globally enable breakpoints 3 through 0, respectively. Unlike L3–L0, G3–G0 are not set to 0 whenever the processor executes a task switch. Not setting G3–G0 to 0 allows breakpoints to remain enabled across all tasks. If a breakpoint is enabled globally but disabled locally, the global enable overrides the local enable.

The LE (bit 8) and GE (bit 9) bits in DR7 have no effect on the operation of the processor and are provided in order to be software compatible with previous generations of x86 processors.

When set to 1, the GD bit in DR7 (bit 13) enables the debug exception associated with the BD bit (bit 13) in DR6. This bit is set to 0 when a debug exception is generated.

LEN3–LEN0 and RW3–RW0 are two-bit fields in DR7 that specify the length and type of each breakpoint as defined in Table 41.

Table 41. DR7 LEN and RW Definitions

LEN Bits ¹	RW Bits	Breakpoint
00b	00b ²	Instruction Execution
00b	01b	One-byte Data Write
01b		Two-byte Data Write
11b		Four-byte Data Write
00b	10b ³	One-byte I/O Read or Write
01b		Two-byte I/O Read or Write
11b		Four-byte I/O Read or Write
00b	11b	One-byte Data Read or Write
01b		Two-byte Data Read or Write
11b		Four-byte Data Read or Write
Notes:		
1. LEN bits equal to 10b is undefined.		
2. When RW equals 00b, LEN must be equal to 00b.		
3. When RW equals 10b, debugging extensions (DE) must be enabled (bit 3 of CR4 must be set to 1). If DE is set to 0, then RW equal to 10b is undefined.		

Debug Exceptions

A debug exception is categorized as either a debug trap or a debug fault. A debug trap calls the debugger following the execution of the instruction that caused the trap. A debug fault calls the debugger prior to the execution of the instruction that caused the fault. All debug traps and faults generate either an Interrupt 01h or an Interrupt 03h exception.

Interrupt 01h. The following events are considered debug traps that cause the processor to generate an Interrupt 01h exception:

- Enabled breakpoints for data and I/O cycles
- Single Step Trap
- Task Switch Trap

The following events are considered debug faults that cause the processor to generate an Interrupt 01h exception:

- Enabled breakpoints for instruction execution
- BD bit in DR6 set to 1

Interrupt 03h. The INT 3 instruction is defined in the x86 architecture as a breakpoint instruction. This instruction causes the processor to generate an Interrupt 03h exception. This exception is a debug trap because the debugger is called following the execution of the INT 3 instruction.

The INT 3 instruction is a one-byte instruction (opcode CCh) typically used to insert a breakpoint in software by writing CCh to the address of the first byte of the instruction to be trapped (the target instruction). Following the trap, if the target instruction is to be executed, the debugger must replace the INT 3 instruction with the first byte of the target instruction.

12 Clock Control

The AMD-K6 processor supports five modes of clock control. The processor can transition between these modes to maximize performance, to minimize power dissipation, or to provide a balance between performance and power. (See “Power Dissipation” on page 235 for the maximum power dissipation of the AMD-K6 processor within the normal and reduced-power states.)

The five clock-control states supported are as follows:

- **Normal State:** The processor is running in Real Mode, Virtual-8086 Mode, Protected Mode, or System Management Mode (SMM). In this state, all clocks are running—including the external bus clock CLK and the internal processor clock—and the full features and functions of the processor are available.
- **Halt State:** This low-power state is entered following the successful execution of the HLT instruction. During this state, the internal processor clock is stopped.
- **Stop Grant State:** This low-power state is entered following the recognition of the assertion of the STPCLK# signal. During this state, the internal processor clock is stopped.
- **Stop Grant Inquire State:** This state is entered from the Halt state and the Stop Grant state as the result of a system-initiated inquire cycle.
- **Stop Clock State:** This low-power state is entered from the Stop Grant state when the CLK signal is stopped.

The following sections describe each of the four low-power states. Figure 78 on page 228 illustrates the clock control state transitions.

12.1 Halt State

Enter Halt State

During the execution of the HLT instruction, the AMD-K6 processor executes a Halt special cycle. After BRDY# is sampled asserted during this cycle, and then EWBE# is also sampled asserted, the processor enters the Halt state in which the processor disables most of its internal clock distribution. In order to support the following operations, the internal phase-lock loop (PLL) still runs, and some internal resources are still clocked in the Halt state:

- **Inquire Cycles:** The processor continues to sample AHOLD, BOFF#, and HOLD in order to support inquire cycles that are initiated by the system logic. The processor transitions to the Stop Grant Inquire state during the inquire cycle. After returning to the Halt state following the inquire cycle, the processor does not execute another Halt special cycle.
- **Flush Cycles:** The processor continues to sample FLUSH#. If FLUSH# is sampled asserted, the processor performs the flush operation in the same manner as it is performed in the Normal state. Upon completing the flush operation, the processor executes the Halt special cycle which indicates the processor is in the Halt state.
- **Time Stamp Counter (TSC):** The TSC continues to count in the Halt state.
- **Signal Sampling:** The processor continues to sample INIT, INTR, NMI, RESET, and SMI#.

After entering the Halt state, all signals driven by the processor retain their state as they existed following the completion of the Halt special cycle.

Exit Halt State

The AMD-K6 processor remains in the Halt state until it samples INIT, INTR (if interrupts are enabled), NMI, RESET, or SMI# asserted. If any of these signals is sampled asserted, the processor returns to the Normal state and performs the corresponding operation. All of the normal requirements for recognition of these input signals apply within the Halt state.

12.2 Stop Grant State

Enter Stop Grant State

After recognizing the assertion of STPCLK#, the AMD-K6 processor flushes its instruction pipelines, completes all pending and in-progress bus cycles, and acknowledges the STPCLK# assertion by executing a Stop Grant special bus cycle. After BRDY# is sampled asserted during this cycle, and then EWBE# is also sampled asserted, the processor enters the Stop Grant state. The Stop Grant state is like the Halt state in that the processor disables most of its internal clock distribution in the Stop Grant state. In order to support the following operations, the internal PLL still runs, and some internal resources are still clocked in the Stop Grant state:

- Inquire cycles: The processor transitions to the Stop Grant Inquire state during an inquire cycle. After returning to the Stop Grant state following the inquire cycle, the processor does not execute another Stop Grant special cycle.
- Time Stamp Counter (TSC): The TSC continues to count in the Stop Grant state.
- Signal Sampling: The processor continues to sample INIT, INTR, NMI, RESET, and SMI#.

FLUSH# is not recognized in the Stop Grant state (unlike while in the Halt state).

Upon entering the Stop Grant state, all signals driven by the processor retain their state as they existed following the completion of the Stop Grant special cycle.

Exit Stop Grant State

The AMD-K6 processor remains in the Stop Grant state until it samples STPCLK# negated or RESET asserted. If STPCLK# is sampled negated, the processor returns to the Normal state in less than 10 bus clock (CLK) periods. After the transition to the Normal state, the processor resumes execution at the instruction boundary on which STPCLK# was initially recognized.

If STPCLK# is recognized as negated in the Stop Grant state and subsequently sampled asserted prior to returning to the Normal state, the AMD-K6 processor guarantees that a minimum of one instruction is executed prior to re-entering the Stop Grant state.

If INIT, INTR (if interrupts are enabled), FLUSH#, NMI, or SMI# are sampled asserted in the Stop Grant state, the processor latches the edge-sensitive signals (INIT, FLUSH#, NMI, and SMI#), but otherwise does not exit the Stop Grant state to service the interrupt. When the processor returns to the Normal state due to sampling STPCLK# negated, any pending interrupts are recognized after returning to the Normal state. To ensure their recognition, all of the normal requirements for these input signals apply within the Stop Grant state.

If RESET is sampled asserted in the Stop Grant state, the processor immediately returns to the Normal state and the reset process begins.

12.3 Stop Grant Inquire State

Enter Stop Grant Inquire State

The Stop Grant Inquire state is entered from the Stop Grant state or the Halt state when EADS# is sampled asserted during an inquire cycle initiated by the system logic. The AMD-K6 processor responds to an inquire cycle in the same manner as in the Normal state by driving HIT# and HITM#. If the inquire cycle hits a modified data cache line, the processor performs a writeback cycle.

Exit Stop Grant Inquire State

Following the completion of any writeback, the processor returns to the state from which it entered the Stop Grant Inquire state.

12.4 Stop Clock State

Enter Stop Clock State

If the CLK signal is stopped while the AMD-K6 processor is in the Stop Grant state, the processor enters the Stop Clock state. Because all internal clocks and the PLL are not running in the Stop Clock state, the Stop Clock state represents the minimum-power state of all clock control states. The CLK signal must be held Low while it is stopped.

The Stop Clock state cannot be entered from the Halt state.

INTR is the only input signal that is allowed to change states while the processor is in the Stop Clock state. However, INTR is not sampled until the processor returns to the Stop Grant state.

All other input signals must remain unchanged in the Stop Clock state.

Exit Stop Clock State

The AMD-K6 processor returns to the Stop Grant state from the Stop Clock state after the CLK signal is started and the internal PLL has stabilized. PLL stabilization is achieved after the CLK signal has been running within its specification for a minimum of 1.0 ms.

The frequency of CLK when exiting the Stop Clock state can be different than the frequency of CLK when entering the Stop Clock state.

The state of the BF[2:0] signals when exiting the Stop Clock state is ignored because the BF[2:0] signals are only sampled during the falling transition of RESET.

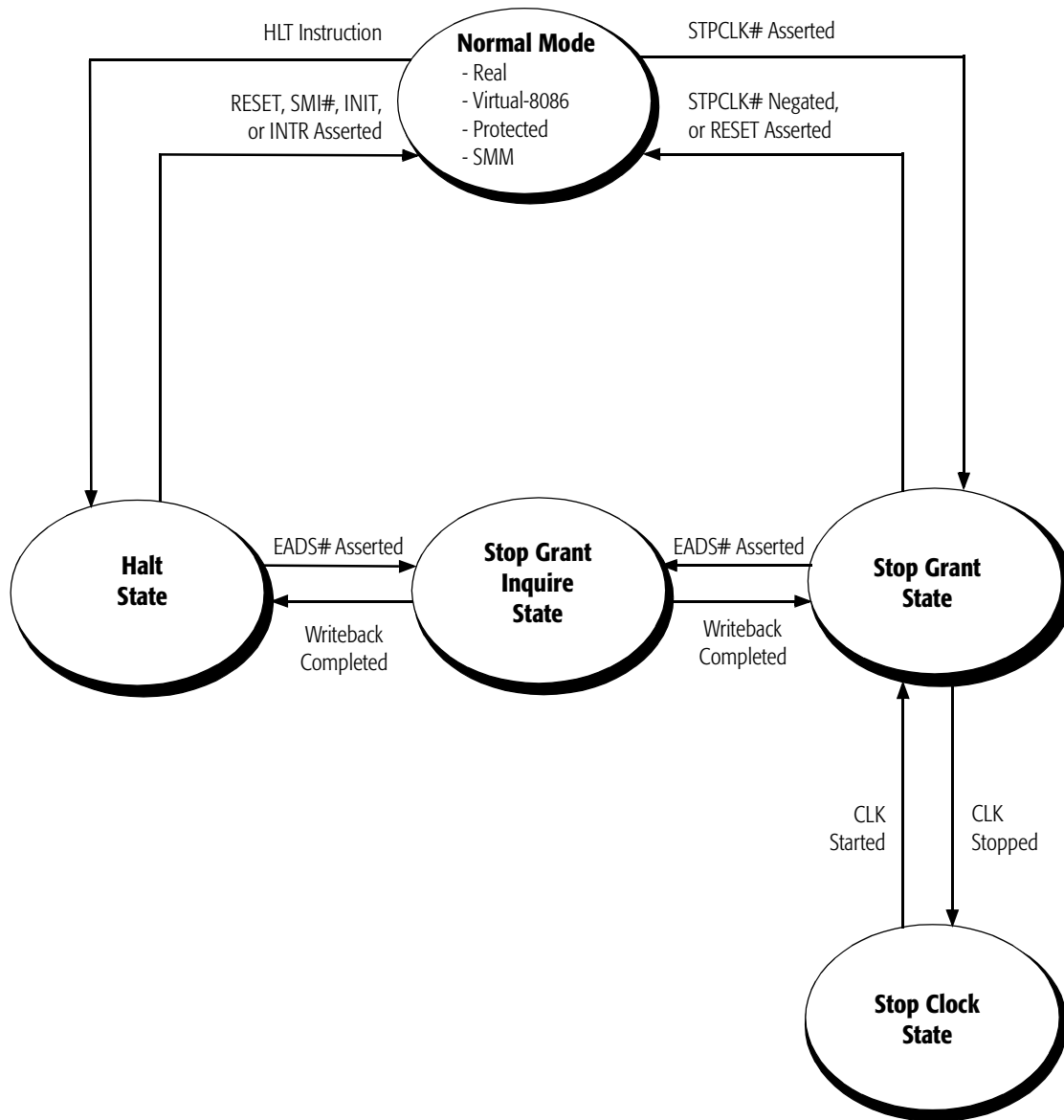

Figure 78. Clock Control State Transitions

13 Power and Grounding

13.1 Power Connections

The AMD-K6 processor is a dual voltage device. Two separate supply voltages are required: V_{CC2} and V_{CC3} . V_{CC2} provides the core voltage for the processor and V_{CC3} provides the I/O voltage. See “Electrical Data” on page 233 for the value and range of V_{CC2} and V_{CC3} .

There are 28 V_{CC2} , 32 V_{CC3} , and 68 V_{SS} pins on the AMD-K6 processor. (See “Pin Designations” on page 269 for all power and ground pin designations.) The large number of power and ground pins are provided to ensure that the processor and package maintain a clean and stable power distribution network.

For proper operation and functionality, all V_{CC2} , V_{CC3} , and V_{SS} pins must be connected to the appropriate planes in the circuit board. The power planes have been arranged in a pattern to simplify routing and minimize crosstalk on the circuit board. The isolation region between two voltage planes must be at least 0.254mm if they are in the same layer of the circuit board. (See Figure 79 on page 230.) In order to maintain a low-impedance current sink and reference, the ground plane must never be split.

Although the AMD-K6 has two separate supply voltages, there are no special power sequencing requirements. The best procedure is to minimize the time between which V_{CC2} and V_{CC3} are either both on or both off.

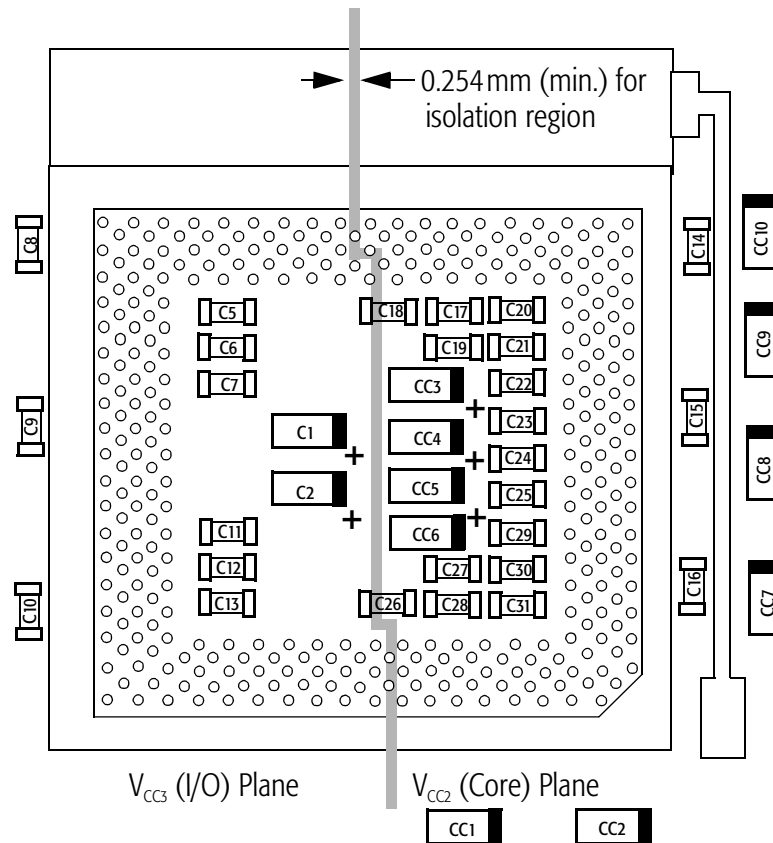

Figure 79. Suggested Component Placement

13.2 Decoupling Recommendations

In addition to the isolation region mentioned in “Power Connections” on page 229, adequate decoupling capacitance is required between the two system power planes and the ground plane to minimize ringing and to provide a low-impedance path for return currents. Suggested decoupling capacitor placement is shown in Figure 79.

Surface mounted capacitors should be used under the processor’s ZIF socket to minimize resistance and inductance in the lead lengths while maintaining minimal height. For information and recommendations about the specific value, quantity, and location of the capacitors, see the *AMD-K6[®] Processor Power Supply Design Application Note*, order# 21103.

13.3 Pin Connection Requirements

For proper operation, the following requirements for signal pin connections must be met:

- Do not drive address and data signals into large capacitive loads at high frequencies. If necessary, use buffer chips to drive large capacitive loads.
- Leave all NC (no-connect) pins unconnected.
- Unused inputs should always be connected to an appropriate signal level.
 - Active Low inputs that are not being used should be connected to V_{CC3} through a 20k- Ω pullup resistor.
 - Active High inputs that are not being used should be connected to GND through a pulldown resistor.
- Reserved signals can be treated in one of the following ways:
 - As no-connect (NC) pins, in which case these pins are left unconnected
 - As pins connected to the system logic as defined by the industry-standard Pentium interface (Socket 7)
 - Any combination of NC and Socket 7 pins
- Keep trace lengths to a minimum.

14 Electrical Data

14.1 Operating Ranges

The functional operation of the AMD-K6 processor is guaranteed if the voltage and temperature parameters are within the limits defined in Table 42.

Table 42. Operating Ranges

Parameter	Minimum	Typical	Maximum	Comments
V_{CC2}	2.755 V	2.9 V	3.045 V	Note 1, 2
	3.1 V	3.2 V	3.3 V	Note 1, 3
V_{CC3}	3.135 V	3.3 V	3.6 V	Note 1
T_{CASE}	0°C		70°C	
Notes:				
1. V_{CC2} and V_{CC3} are referenced from V_{SS} .				
2. V_{CC2} specification for 2.9 V components.				
3. V_{CC2} specification for 3.2 V components.				

14.2 Absolute Ratings

While functional operation is not guaranteed beyond the operating ranges listed in Table 42, no long-term reliability or functional damage is caused as long as the AMD-K6 processor is not subjected to conditions exceeding the absolute ratings listed in Table 43.

Table 43. Absolute Ratings

Parameter	Minimum	Maximum	Comments
V_{CC2}	-0.5 V	3.5 V	
V_{CC3}	-0.5 V	4.0 V	
V_{PIN}	-0.5 V	$V_{CC3}+0.5$ V and ≤ 4.0 V	Note
T_{CASE} (under bias)	-65°C	+110°C	
$T_{STORAGE}$	-65°C	+150°C	
Note:			
V_{PIN} (the voltage on any I/O pin) must not be greater than 0.5 V above the voltage being applied to V_{CC3} . In addition, the V_{PIN} voltage must never exceed 4.0 V.			

14.3 DC Characteristics

The DC characteristics of the AMD-K6 processor are shown in Table 44.

Table 44. DC Characteristics

Symbol	Parameter Description	Preliminary Data		Comments
		Min	Max	
V_{IL}	Input Low Voltage	-0.3 V	+0.8 V	
V_{IH}	Input High Voltage	2.0 V	$V_{CC3} + 0.3$ V	Note 1
V_{OL}	Output Low Voltage		0.4 V	$I_{OL} = 4.0$ -mA load
V_{OH}	Output High Voltage	2.4 V		$I_{OH} = 3.0$ -mA load
I_{CC2}	2.9 V Power Supply Current		6.25 A	166 MHz, Note 2
			7.50 A	200 MHz, Note 2
I_{CC2}	3.2 V Power Supply Current		9.50 A	233 MHz, Note 3
I_{CC3}	3.3 V Power Supply Current		0.48 A	166 MHz, Note 4
			0.50 A	200 MHz, Note 4
			0.52 A	233 MHz, Note 4
I_{LI}	Input Leakage Current		± 15 μ A	Note 5
I_{LO}	Output Leakage Current		± 15 μ A	Note 5
I_{IL}	Input Leakage Current Bias with Pullup		-400 μ A	Note 6
I_{IH}	Input Leakage Current Bias with Pulldown		200 μ A	Note 7
C_{IN}	Input Capacitance		15 pF	
C_{OUT}	Output Capacitance		20 pF	
C_{OUT}	I/O Capacitance		25 pF	
C_{CLK}	CLK Capacitance		15 pF	
C_{TIN}	Test Input Capacitance (TDI, TMS, TRST#)		15 pF	
C_{TOUT}	Test Output Capacitance (TDO)		20 pF	
C_{TCK}	TCK Capacitance		15 pF	

Notes:

1. V_{CC3} refers to the voltage being applied to V_{CC3} during functional operation.
2. $V_{CC2} = 3.045$ V – The maximum power supply current must be taken into account when designing a power supply.
3. $V_{CC2} = 3.3$ V – The maximum power supply current must be taken into account when designing a power supply.
4. $V_{CC3} = 3.6$ V – The maximum power supply current must be taken into account when designing a power supply.
5. Refers to inputs and I/O without an internal pullup resistor and $0 \leq V_{IN} \leq V_{CC3}$.
6. Refers to inputs with an internal pullup and $V_{IL} = 0.4$ V.
7. Refers to inputs with an internal pulldown and $V_{IH} = 2.4$ V.

14.4 Power Dissipation

Table 45 contains the typical and maximum power dissipation of the AMD-K6 processor during normal and reduced power states.

Table 45. Typical and Maximum Power Dissipation

Clock Control State	2.9 V Component		3.2 V Component	Comments
	166 MHz	200 MHz	233 MHz	
Normal (Maximum Thermal Power)	17.2 W	20.0 W	28.3 W	Note 1, 2
Normal (Typical Thermal Power)	10.3 W	12.0 W	17.0 W	Note 3
Stop Grant / Halt (Maximum)	1.45 W	1.53 W	1.75 W	Note 4
Stop Clock (Maximum)	1.0 W	1.0 W	1.0 W	Note 5

Notes:

1. The maximum power dissipated in the normal clock control state must be taken into account when designing a solution for thermal dissipation for the AMD-K6 processor.
2. Maximum power is determined for the worst-case instruction sequence or function for the listed clock control states with $V_{CC2} = 2.9\text{ V}$ (for the 2.9 V component) or $V_{CC2} = 3.2\text{ V}$ (for the 3.2 V component), and $V_{CC3} = 3.3\text{ V}$.
3. Typical power is determined for the typical instruction sequences or functions associated with normal system operation with $V_{CC2} = 2.9\text{ V}$ (for the 2.9 V component) or $V_{CC2} = 3.2\text{ V}$ (for the 3.2 V component), and $V_{CC3} = 3.3\text{ V}$.
4. The CLK signal and the internal PLL are still running but most internal clocking has stopped.
5. The CLK signal, the internal PLL, and all internal clocking has stopped.

15 I/O Buffer Characteristics

All of the AMD-K6 processor inputs, outputs, and bidirectional buffers are implemented using a 3.3 V buffer design. In addition, a subset of the processor I/O buffers include a second, higher drive strength option. These buffers can be configured to provide the higher drive strength for applications that place a heavier load on these I/O signals.

AMD has developed two I/O buffer models that represent the characteristics of each of the two possible drive strength configurations supported by the AMD-K6. These two models are called the Standard I/O Model and the Strong I/O Model.

AMD developed the two models to allow system designers to perform analog simulations of AMD-K6 signals that interface with the system logic. Analog simulations are used to determine a signal's time of flight from source to destination and to ensure that the system's signal quality requirements are met. Signal quality measurements include overshoot, undershoot, slope reversal, and ringing.

15.1 Selectable Drive Strength

The AMD-K6 processor samples the BRDYC# input during the falling transition of RESET to configure the drive strength of A[20:3], ADS#, HITM# and W/R#. If BRDYC# is 0 during the fall of RESET, these particular outputs are configured using the higher drive strength. If BRDYC# is 1 during the fall of RESET, the standard drive strength is selected for all I/O buffers.

Table 46 shows the relationship between BRDYC# and the two available drive strengths — K6STD and K6STG.

Table 46. A[20:3], ADS#, HITM#, and W/R# Strength Selection

Drive Strength	BRDYC#	I/O Buffer Name
Strength 1 (standard)	1	K6STD
Strength 2 (strong)	0	K6STG

15.2 I/O Buffer Model

AMD provides models of the AMD-K6 processor I/O buffers for system designers to use in board-level simulations. These I/O buffer models conform to the *I/O Buffer Information Specification (IBIS), Version 2.1*. The Standard I/O Model uses K6STD, the standard I/O buffer representation, for all I/O buffers. The Strong I/O Model uses K6STG, the stronger I/O buffer representation for A[20:3], ADS#, HITM#, and W/R#, and uses K6STD for the remainder of the I/O buffers.

Both I/O models contain voltage versus current (V/I) and voltage versus time (V/T) data tables for accurate modeling of I/O buffer behavior.

The following list characterizes the properties of each I/O buffer model:

- All data tables contain minimum, typical, and maximum values to allow for worst-case, typical, and best-case simulations, respectively.
- The pullup, pulldown, power clamp, and ground clamp device V/I tables contain enough data points to accurately represent the nonlinear nature of the V/I curves. In addition, the voltage ranges provided in these tables extend beyond the normal operating range of the AMD-K6 processor for those simulators that yield more accurate results based on this wider range. Figure 80 and Figure 81 on page 239 illustrate the min/typ/max pulldown and pullup V/I curves for K6STD between 0V and 3.3V.
- The rising and falling ramp rates are specified.
- The min/typ/max V_{CC3} operating range is specified as 3.135V, 3.3V, and 3.6V, respectively.
- $V_{il} = 0.8V$, $V_{ih} = 2.0V$, and $V_{meas} = 1.5V$
- The R/L/C of the package is modeled.
- The capacitance of the silicon die is modeled.
- The model assumes the test load is 0 capacitance, resistance, inductance, and voltage.

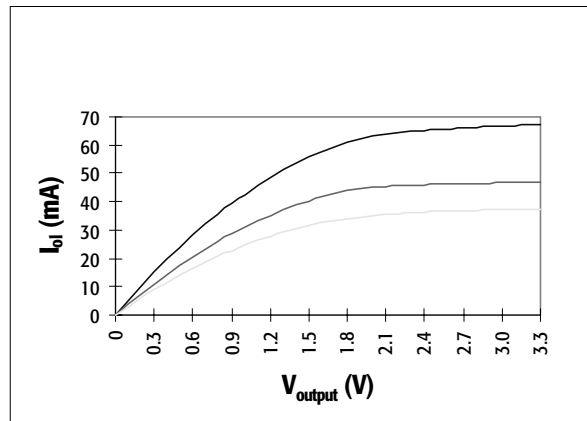

Figure 80. K6STD Pulldown V/I Curves

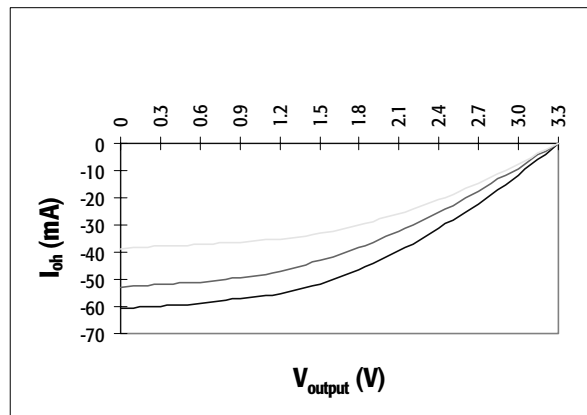

Figure 81. K6STD Pullup V/I Curves

15.3 I/O Model Application Note

For the AMD-K6 processor I/O Buffer IBIS Models and their application, refer to the *AMD-K6[®] Processor I/O Model (IBIS) Application Note*, order# 21084.

15.4 I/O Buffer AC and DC Characteristics

See “Signal Switching Characteristics” on page 241 for the AMD-K6 processor AC timing specifications.

See “Electrical Data” on page 233 for the AMD-K6 processor DC specifications.

16 Signal Switching Characteristics

The AMD-K6 processor signal switching characteristics are presented in Table 47 through Table 55. Valid delay, float, setup, and hold timing specifications are listed. These specifications are provided for the system designer to determine if the timings necessary for the processor to interface with the system logic are met. Table 47 and Table 48 contain the switching characteristics of the CLK input. Table 49 through Table 52 contain the timings for the normal operation signals. Table 53 contains the timings for RESET and the configuration signals. Table 54 and Table 55 contain the timings for the test operation signals.

All signal timings provided are:

- Measured between CLK, TCK, or RESET at 1.5 V and the corresponding signal at 1.5 V—this applies to input and output signals that are switching from Low to High, or from High to Low
- Based on input signals applied at a slew rate of 1 V/ns between 0 V and 3 V (rising) and 3 V to 0 V (falling)
- Valid within the operating ranges given in “Operating Ranges” on page 233
- Based on a load capacitance (C_L) of 0 pF

16.1 CLK Switching Characteristics

Table 47 and Table 48 contain the switching characteristics of the CLK input to the AMD-K6 processor for 66-MHz and 60-MHz bus operation, respectively, as measured at the voltage levels indicated by Figure 82.

The CLK Period Stability specifies the variance (jitter) allowed between successive periods of the CLK input measured at 1.5 V. This parameter must be considered as one of the elements of clock skew between the AMD-K6 and the system logic.

16.2 Clock Switching Characteristics for 66-MHz Bus Operation

Table 47. CLK Switching Characteristics for 66-MHz Bus Operation

Symbol	Parameter Description	Preliminary Data		Figure	Comments
		Min	Max		
	Frequency	33.3 MHz	66.6 MHz		In Normal Mode
t ₁	CLK Period	15.0 ns	30.0 ns	82	In Normal Mode
t ₂	CLK High Time	4.0 ns		82	
t ₃	CLK Low Time	4.0 ns		82	
t ₄	CLK Fall Time	0.15 ns	1.5 ns	82	
t ₅	CLK Rise Time	0.15 ns	1.5 ns	82	
	CLK Period Stability		± 250 ps		Note

Note:
Jitter frequency power spectrum peaking must occur at frequencies greater than (Frequency of CLK)/3 or less than 500 KHz.

16.3 Clock Switching Characteristics for 60-MHz Bus Operation

Table 48. CLK Switching Characteristics for 60-MHz Bus Operation

Symbol	Parameter Description	Preliminary Data		Figure	Comments
		Min	Max		
	Frequency	30 MHz	60 MHz		In Normal Mode
t ₁	CLK Period	16.67 ns	33.33 ns	82	In Normal Mode
t ₂	CLK High Time	4.0 ns		82	
t ₃	CLK Low Time	4.0 ns		82	
t ₄	CLK Fall Time	0.15 ns	1.5 ns	82	
t ₅	CLK Rise Time	0.15 ns	1.5 ns	82	
	CLK Period Stability		± 250 ps		Note

Note:
Jitter frequency power spectrum peaking must occur at frequencies greater than (Frequency of CLK)/3 or less than 500 KHz.

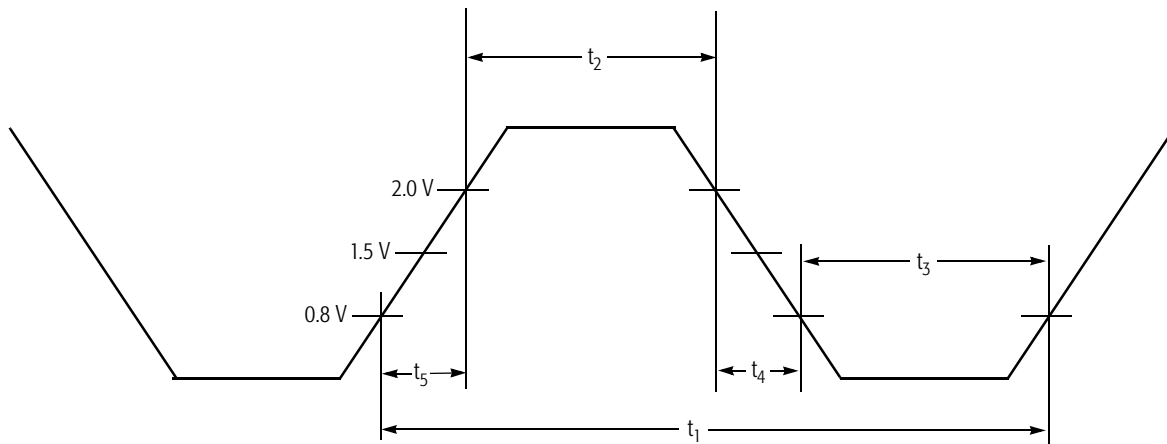

Figure 82. CLK Waveform

16.4 Valid Delay, Float, Setup, and Hold Timings

Valid delay and float timings are given for output signals during functional operation and are given relative to the rising edge of CLK. During boundary-scan testing, valid delay and float timings for output signals are with respect to the falling edge of TCK. The maximum valid delay timings are provided to allow a system designer to determine if setup times to the system logic can be met. Likewise, the minimum valid delay timings are used to analyze hold times to the system logic.

The setup and hold time requirements for the AMD-K6 processor input signals must be met by the system logic to assure the proper operation of the AMD-K6. The setup and hold timings during functional and boundary-scan test mode are given relative to the rising edge of CLK and TCK, respectively.

16.5 Output Delay Timings for 66-MHz Bus Operation

Table 49. Output Delay Timings for 66-MHz Bus Operation

Symbol	Parameter Description	Preliminary Data		Figure	Comments
		Min	Max		
t ₆	A[31:3] Valid Delay	1.1 ns	6.3 ns	84	
t ₇	A[31:3] Float Delay		10.0 ns	85	
t ₈	ADS# Valid Delay	1.0 ns	6.0 ns	84	
t ₉	ADS# Float Delay		10.0 ns	85	
t ₁₀	ADSC# Valid Delay	1.0 ns	7.0 ns	84	
t ₁₁	ADSC# Float Delay		10.0 ns	85	
t ₁₂	AP Valid Delay	1.0 ns	8.5 ns	84	
t ₁₃	AP Float Delay		10.0 ns	85	
t ₁₄	APCHK# Valid Delay	1.0 ns	8.3 ns	84	
t ₁₅	BE[7:0]# Valid Delay	1.0 ns	7.0 ns	84	
t ₁₆	BE[7:0]# Float Delay		10.0 ns	85	
t ₁₇	BREQ Valid Delay	1.0 ns	8.0 ns	84	
t ₁₈	CACHE# Valid Delay	1.0 ns	7.0 ns	84	
t ₁₉	CACHE# Float Delay		10.0 ns	85	
t ₂₀	D/C# Valid Delay	1.0 ns	7.0 ns	84	
t ₂₁	D/C# Float Delay		10.0 ns	85	
t ₂₂	D[63:0] Write Data Valid Delay	1.3 ns	7.5 ns	84	
t ₂₃	D[63:0] Write Data Float Delay		10.0 ns	85	
t ₂₄	DP[7:0] Write Data Valid Delay	1.3 ns	7.5 ns	84	
t ₂₅	DP[7:0] Write Data Float Delay		10.0 ns	85	
t ₂₆	FERR# Valid Delay	1.0 ns	8.3 ns	84	
t ₂₇	HIT# Valid Delay	1.0 ns	6.8 ns	84	
t ₂₈	HITM# Valid Delay	1.1 ns	6.0 ns	84	
t ₂₉	HLDA Valid Delay	1.0 ns	6.8 ns	84	
t ₃₀	LOCK# Valid Delay	1.1 ns	7.0 ns	84	
t ₃₁	LOCK# Float Delay		10.0 ns	85	
t ₃₂	M/IO# Valid Delay	1.0 ns	5.9 ns	84	
t ₃₃	M/IO# Float Delay		10.0 ns	85	

Table 49. Output Delay Timings for 66-MHz Bus Operation (continued)

Symbol	Parameter Description	Preliminary Data		Figure	Comments
		Min	Max		
t ₃₄	PCD Valid Delay	1.0 ns	7.0 ns	84	
t ₃₅	PCD Float Delay		10.0 ns	85	
t ₃₆	PCHK# Valid Delay	1.0 ns	7.0 ns	84	
t ₃₇	PWT Valid Delay	1.0 ns	7.0 ns	84	
t ₃₈	PWT Float Delay		10.0 ns	85	
t ₃₉	SCYC Valid Delay	1.0 ns	7.0 ns	84	
t ₄₀	SCYC Float Delay		10.0 ns	85	
t ₄₁	SMIACK# Valid Delay	1.0 ns	7.3 ns	84	
t ₄₂	W/R# Valid Delay	1.0 ns	7.0 ns	84	
t ₄₃	W/R# Float Delay		10.0 ns	85	

16.6 Input Setup and Hold Timings for 66-MHz Bus Operation

Table 50. Input Setup and Hold Timings for 66-MHz Bus Operation

Symbol	Parameter Description	Preliminary Data		Figure	Comments
		Min	Max		
t ₄₄	A[31:5] Setup Time	6.0 ns		86	
t ₄₅	A[31:5] Hold Time	1.0 ns		86	
t ₄₆	A20M# Setup Time	5.0 ns		86	Note 1
t ₄₇	A20M# Hold Time	1.0 ns		86	Note 1
t ₄₈	AHOLD Setup Time	5.5 ns		86	
t ₄₉	AHOLD Hold Time	1.0 ns		86	
t ₅₀	AP Setup Time	5.0 ns		86	
t ₅₁	AP Hold Time	1.0 ns		86	
t ₅₂	BOFF# Setup Time	5.5 ns		86	
t ₅₃	BOFF# Hold Time	1.0 ns		86	
t ₅₄	BRDY# Setup Time	5.0 ns		86	
t ₅₅	BRDY# Hold Time	1.0 ns		86	
t ₅₆	BRDYC# Setup Time	5.0 ns		86	
t ₅₇	BRDYC# Hold Time	1.0 ns		86	
t ₅₈	D[63:0] Read Data Setup Time	2.8 ns		86	
t ₅₉	D[63:0] Read Data Hold Time	1.5 ns		86	
t ₆₀	DP[7:0] Read Data Setup Time	2.8 ns		86	
t ₆₁	DP[7:0] Read Data Hold Time	1.5 ns		86	
t ₆₂	EADS# Setup Time	5.0 ns		86	
t ₆₃	EADS# Hold Time	1.0 ns		86	
t ₆₄	EWBE# Setup Time	5.0 ns		86	
t ₆₅	EWBE# Hold Time	1.0 ns		86	
t ₆₆	FLUSH# Setup Time	5.0 ns		86	Note 2
t ₆₇	FLUSH# Hold Time	1.0 ns		86	Note 2

Notes:

1. These level-sensitive signals can be asserted synchronously or asynchronously. To be sampled on a specific clock edge, setup and hold times must be met. If asserted asynchronously, they must be asserted for a minimum pulse width of two clocks.
2. These edge-sensitive signals can be asserted synchronously or asynchronously. To be sampled on a specific clock edge, setup and hold times must be met. If asserted asynchronously, they must have been negated at least two clocks prior to assertion and must remain asserted at least two clocks.

Table 50. Input Setup and Hold Timings for 66-MHz Bus Operation (continued)

Symbol	Parameter Description	Preliminary Data		Figure	Comments
		Min	Max		
t ₆₈	HOLD Setup Time	5.0 ns		86	
t ₆₉	HOLD Hold Time	1.5 ns		86	
t ₇₀	IGNNE# Setup Time	5.0 ns		86	Note 1
t ₇₁	IGNNE# Hold Time	1.0 ns		86	Note 1
t ₇₂	INIT Setup Time	5.0 ns		86	Note 2
t ₇₃	INIT Hold Time	1.0 ns		86	Note 2
t ₇₄	INTR Setup Time	5.0 ns		86	Note 1
t ₇₅	INTR Hold Time	1.0 ns		86	Note 1
t ₇₆	INV Setup Time	5.0 ns		86	
t ₇₇	INV Hold Time	1.0 ns		86	
t ₇₈	KEN# Setup Time	5.0 ns		86	
t ₇₉	KEN# Hold Time	1.0 ns		86	
t ₈₀	NA# Setup Time	4.5 ns		86	
t ₈₁	NA# Hold Time	1.0 ns		86	
t ₈₂	NMI Setup Time	5.0 ns		86	Note 2
t ₈₃	NMI Hold Time	1.0 ns		86	Note 2
t ₈₄	SMI# Setup Time	5.0 ns		86	Note 2
t ₈₅	SMI# Hold Time	1.0 ns		86	Note 2
t ₈₆	STPCLK# Setup Time	5.0 ns		86	Note 1
t ₈₇	STPCLK# Hold Time	1.0 ns		86	Note 1
t ₈₈	WB/WT# Setup Time	4.5 ns		86	
t ₈₉	WB/WT# Hold Time	1.0 ns		86	

Notes:

1. These level-sensitive signals can be asserted synchronously or asynchronously. To be sampled on a specific clock edge, setup and hold times must be met. If asserted asynchronously, they must be asserted for a minimum pulse width of two clocks.
2. These edge-sensitive signals can be asserted synchronously or asynchronously. To be sampled on a specific clock edge, setup and hold times must be met. If asserted asynchronously, they must have been negated at least two clocks prior to assertion and must remain asserted at least two clocks.

16.7 Output Delay Timings for 60-MHz Bus Operation

Table 51. Output Delay Timings for 60-MHz Bus Operation

Symbol	Parameter Description	Preliminary Data		Figure	Comments
		Min	Max		
t ₆	A[31:3] Valid Delay	1.1 ns	6.3 ns	84	
t ₇	A[31:3] Float Delay		10.0 ns	85	
t ₈	ADS# Valid Delay	1.0 ns	7.0 ns	84	
t ₉	ADS# Float Delay		10.0 ns	85	
t ₁₀	ADSC# Valid Delay	1.0 ns	7.0 ns	84	
t ₁₁	ADSC# Float Delay		10.0 ns	85	
t ₁₂	AP Valid Delay	1.0 ns	8.5 ns	84	
t ₁₃	AP Float Delay		10.0 ns	85	
t ₁₄	APCHK# Valid Delay	1.0 ns	8.3 ns	84	
t ₁₅	BE[7:0]# Valid Delay	1.0 ns	7.0 ns	84	
t ₁₆	BE[7:0]# Float Delay		10.0 ns	85	
t ₁₇	BREQ Valid Delay	1.0 ns	8.0 ns	84	
t ₁₈	CACHE# Valid Delay	1.0 ns	7.0 ns	84	
t ₁₉	CACHE# Float Delay		10.0 ns	85	
t ₂₀	D/C# Valid Delay	1.0 ns	7.0 ns	84	
t ₂₁	D/C# Float Delay		10.0 ns	85	
t ₂₂	D[63:0] Write Data Valid Delay	1.3 ns	7.5 ns	84	
t ₂₃	D[63:0] Write Data Float Delay		10.0 ns	85	
t ₂₄	DP[7:0] Write Data Valid Delay	1.3 ns	7.5 ns	84	
t ₂₅	DP[7:0] Write Data Float Delay		10.0 ns	85	
t ₂₆	FERR# Valid Delay	1.0 ns	8.3 ns	84	
t ₂₇	HIT# Valid Delay	1.0 ns	8.0 ns	84	
t ₂₈	HITM# Valid Delay	1.1 ns	6.0 ns	84	
t ₂₉	HLDA Valid Delay	1.0 ns	8.0 ns	84	
t ₃₀	LOCK# Valid Delay	1.1 ns	7.0 ns	84	
t ₃₁	LOCK# Float Delay		10.0 ns	85	
t ₃₂	M/IO# Valid Delay	1.0 ns	7.0 ns	84	
t ₃₃	M/IO# Float Delay		10.0 ns	85	

Table 51. Output Delay Timings for 60-MHz Bus Operation (continued)

Symbol	Parameter Description	Preliminary Data		Figure	Comments
		Min	Max		
t ₃₄	PCD Valid Delay	1.0 ns	7.0 ns	84	
t ₃₅	PCD Float Delay		10.0 ns	85	
t ₃₆	PCHK# Valid Delay	1.0 ns	7.0 ns	84	
t ₃₇	PWT Valid Delay	1.0 ns	7.0 ns	84	
t ₃₈	PWT Float Delay		10.0 ns	85	
t ₃₉	SCYC Valid Delay	1.0 ns	7.0 ns	84	
t ₄₀	SCYC Float Delay		10.0 ns	85	
t ₄₁	SMIACK# Valid Delay	1.0 ns	7.6 ns	84	
t ₄₂	W/R# Valid Delay	1.0 ns	7.0 ns	84	
t ₄₃	W/R# Float Delay		10.0 ns	85	

16.8 Input Setup and Hold Timings for 60-MHz Bus Operation

Table 52. Input Setup and Hold Timings for 60-MHz Bus Operation

Symbol	Parameter Description	Preliminary Data		Figure	Comments
		Min	Max		
t ₄₄	A[31:5] Setup Time	6.0 ns		86	
t ₄₅	A[31:5] Hold Time	1.0 ns		86	
t ₄₆	A20M# Setup Time	5.0 ns		86	Note 1
t ₄₇	A20M# Hold Time	1.0 ns		86	Note 1
t ₄₈	AHOLD Setup Time	5.5 ns		86	
t ₄₉	AHOLD Hold Time	1.0 ns		86	
t ₅₀	AP Setup Time	5.0 ns		86	
t ₅₁	AP Hold Time	1.0 ns		86	
t ₅₂	BOFF# Setup Time	5.5 ns		86	
t ₅₃	BOFF# Hold Time	1.0 ns		86	
t ₅₄	BRDY# Setup Time	5.0 ns		86	
t ₅₅	BRDY# Hold Time	1.0 ns		86	
t ₅₆	BRDYC# Setup Time	5.0 ns		86	
t ₅₇	BRDYC# Hold Time	1.0 ns		86	
t ₅₈	D[63:0] Read Data Setup Time	3.0 ns		86	
t ₅₉	D[63:0] Read Data Hold Time	1.5 ns		86	
t ₆₀	DP[7:0] Read Data Setup Time	3.0 ns		86	
t ₆₁	DP[7:0] Read Data Hold Time	1.5 ns		86	
t ₆₂	EADS# Setup Time	5.5 ns		86	
t ₆₃	EADS# Hold Time	1.0 ns		86	
t ₆₄	EWBE# Setup Time	5.0 ns		86	
t ₆₅	EWBE# Hold Time	1.0 ns		86	
t ₆₆	FLUSH# Setup Time	5.0 ns		86	Note 2
t ₆₇	FLUSH# Hold Time	1.0 ns		86	Note 2

Notes:

1. These level-sensitive signals can be asserted synchronously or asynchronously. To be sampled on a specific clock edge, setup and hold times must be met. If asserted asynchronously, they must be asserted for a minimum pulse width of two clocks.
2. These edge-sensitive signals can be asserted synchronously or asynchronously. To be sampled on a specific clock edge, setup and hold times must be met. If asserted asynchronously, they must have been negated at least two clocks prior to assertion and must remain asserted at least two clocks.

Table 52. Input Setup and Hold Timings for 60-MHz Bus Operation (continued)

Symbol	Parameter Description	Preliminary Data		Figure	Comments
		Min	Max		
t ₆₈	HOLD Setup Time	5.0 ns		86	
t ₆₉	HOLD Hold Time	1.5 ns		86	
t ₇₀	IGNNE# Setup Time	5.0 ns		86	Note 1
t ₇₁	IGNNE# Hold Time	1.0 ns		86	Note 1
t ₇₂	INIT Setup Time	5.0 ns		86	Note 2
t ₇₃	INIT Hold Time	1.0 ns		86	Note 2
t ₇₄	INTR Setup Time	5.0 ns		86	Note 1
t ₇₅	INTR Hold Time	1.0 ns		86	Note 1
t ₇₆	INV Setup Time	5.0 ns		86	
t ₇₇	INV Hold Time	1.0 ns		86	
t ₇₈	KEN# Setup Time	5.0 ns		86	
t ₇₉	KEN# Hold Time	1.0 ns		86	
t ₈₀	NA# Setup Time	4.5 ns		86	
t ₈₁	NA# Hold Time	1.0 ns		86	
t ₈₂	NMI Setup Time	5.0 ns		86	Note 2
t ₈₃	NMI Hold Time	1.0 ns		86	Note 2
t ₈₄	SMI# Setup Time	5.0 ns		86	Note 2
t ₈₅	SMI# Hold Time	1.0 ns		86	Note 2
t ₈₆	STPCLK# Setup Time	5.0 ns		86	Note 1
t ₈₇	STPCLK# Hold Time	1.0 ns		86	Note 1
t ₈₈	WB/WT# Setup Time	4.5 ns		86	
t ₈₉	WB/WT# Hold Time	1.0 ns		86	

Notes:

1. These level-sensitive signals can be asserted synchronously or asynchronously. To be sampled on a specific clock edge, setup and hold times must be met. If asserted asynchronously, they must be asserted for a minimum pulse width of two clocks.
2. These edge-sensitive signals can be asserted synchronously or asynchronously. To be sampled on a specific clock edge, setup and hold times must be met. If asserted asynchronously, they must have been negated at least two clocks prior to assertion and must remain asserted at least two clocks.

16.9 RESET and Test Signal Timing

Table 53. RESET and Configuration Signals (60-MHz and 66-MHz Operation)

Symbol	Parameter Description	Preliminary Data		Figure	Comments
		Min	Max		
t ₉₀	RESET Setup Time	5.0 ns		87	
t ₉₁	RESET Hold Time	1.0 ns		87	
t ₉₂	RESET Pulse Width, V _{CC} and CLK Stable	15 clocks		87	
t ₉₃	RESET Active After V _{CC} and CLK Stable	1.0 ms		87	
t ₉₄	BF[2:0] Setup Time	1.0 ms		87	Note 3
t ₉₅	BF[2:0] Hold Time	2 clocks		87	Note 3
t ₉₆	BRDYC# Hold Time	1.0 ns		87	Note 4
t ₉₇	BRDYC# Setup Time	2 clocks		87	Note 2
t ₉₈	BRDYC# Hold Time	2 clocks		87	Note 2
t ₉₉	FLUSH# Setup Time	5.0 ns		87	Note 1
t ₁₀₀	FLUSH# Hold Time	1.0 ns		87	Note 1
t ₁₀₁	FLUSH# Setup Time	2 clocks		87	Note 2
t ₁₀₂	FLUSH# Hold Time	2 clocks		87	Note 2

Notes:

1. To be sampled on a specific clock edge, setup and hold times must be met the clock edge before the clock edge on which RESET is sampled negated.
2. If asserted asynchronously, these signals must meet a minimum setup and hold time of two clocks relative to the negation of RESET.
3. BF[2:0] must meet a minimum setup time of 1.0 ms and a minimum hold time of two clocks relative to the negation of RESET.
4. If RESET is driven synchronously, BRDYC# must meet the specified hold time relative to the negation of RESET.

Table 54. TCK Waveform and TRST# Timing at 25 MHz

Symbol	Parameter Description	Preliminary Data		Figure	Comments
		Min	Max		
	TCK Frequency		25 MHz	88	
t ₁₀₃	TCK Period	40.0 ns		88	
t ₁₀₄	TCK High Time	14.0 ns		88	
t ₁₀₅	TCK Low Time	14.0 ns		88	
t ₁₀₆	TCK Fall Time		5.0 ns	88	Note 1, 2
t ₁₀₇	TCK Rise Time		5.0 ns	88	Note 1, 2
t ₁₀₈	TRST# Pulse Width	30.0 ns		89	Asynchronous

Notes:

- Rise/Fall times can be increased by 1.0 ns for each 10 MHz that TCK is run below its maximum frequency of 25 MHz.
- Rise/Fall times are measured between 0.8 V and 2.0 V.

Table 55. Test Signal Timing at 25 MHz

Symbol	Parameter Description	Preliminary Data		Figure	Notes
		Min	Max		
t ₁₀₉	TDI Setup Time	5.0 ns		90	Note 2
t ₁₁₀	TDI Hold Time	9.0 ns		90	Note 2
t ₁₁₁	TMS Setup Time	5.0 ns		90	Note 2
t ₁₁₂	TMS Hold Time	9.0 ns		90	Note 2
t ₁₁₃	TDO Valid Delay	3.0 ns	13.0 ns	90	Note 1
t ₁₁₄	TDO Float Delay		16.0 ns	90	Note 1
t ₁₁₅	All Outputs (Non-Test) Valid Delay	3.0 ns	13.0 ns	90	Note 1
t ₁₁₆	All Outputs (Non-Test) Float Delay		16.0 ns	90	Note 1
t ₁₁₇	All Inputs (Non-Test) Setup Time	5.0 ns		90	Note 2
t ₁₁₈	All Inputs (Non-Test) Hold Time	9.0 ns		90	Note 2

Notes:

- Parameter is measured from the TCK falling edge.
- Parameter is measured from the TCK rising edge.

WAVEFORM	INPUTS	OUTPUTS
	Must be steady	Steady
	Can change from High to Low	Changing from High to Low
	Can change from Low to High	Changing from Low to High
	Don't care, any change permitted	Changing, State Unknown
	(Does not apply)	Center line is high impedance state

Figure 83. Diagrams Key

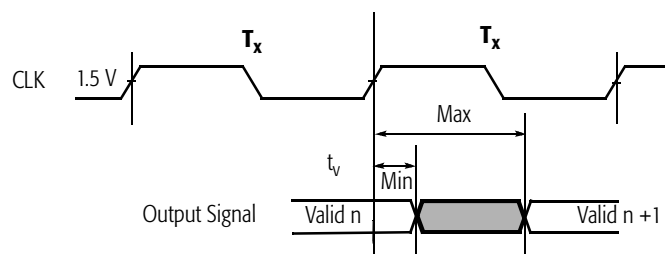

v = 6, 8, 10, 12, 14, 15, 17, 18, 20, 22, 24, 26, 27, 28, 29, 30, 32, 34, 36, 37, 39, 41, 42

Figure 84. Output Valid Delay Timing

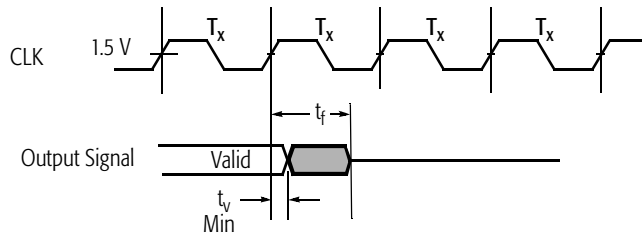

v = 6, 8, 10, 12, 15, 18, 20, 22, 24, 30, 32, 34, 37, 39, 42

f = 7, 9, 11, 13, 16, 19, 21, 23, 25, 31, 33, 35, 38, 40, 43

Figure 85. Maximum Float Delay Timing

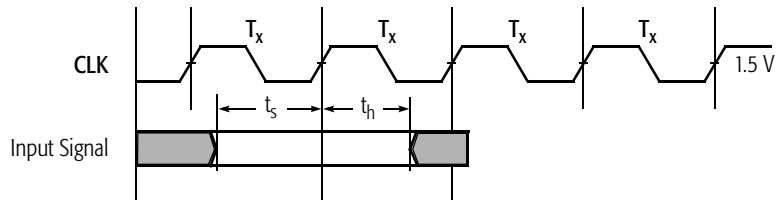

s = 44, 46, 48, 50, 52, 54, 56, 58, 60, 62, 64, 66, 68, 70, 72, 74, 76, 78, 80, 82, 84, 86, 88

h = 45, 47, 49, 51, 53, 55, 57, 59, 61, 63, 65, 67, 69, 71, 73, 75, 77, 79, 81, 83, 85, 87, 89

Figure 86. Input Setup and Hold Timing

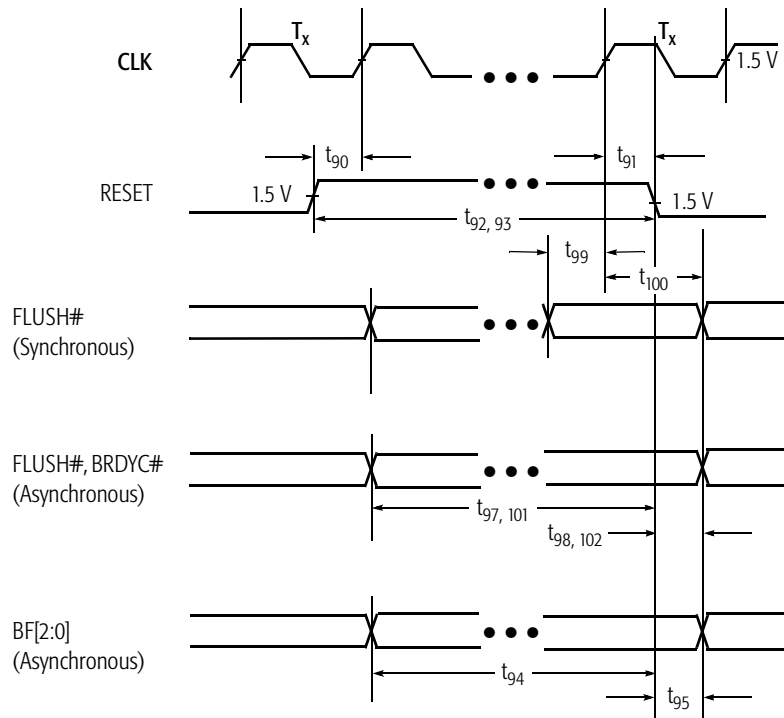

Figure 87. Reset and Configuration Timing

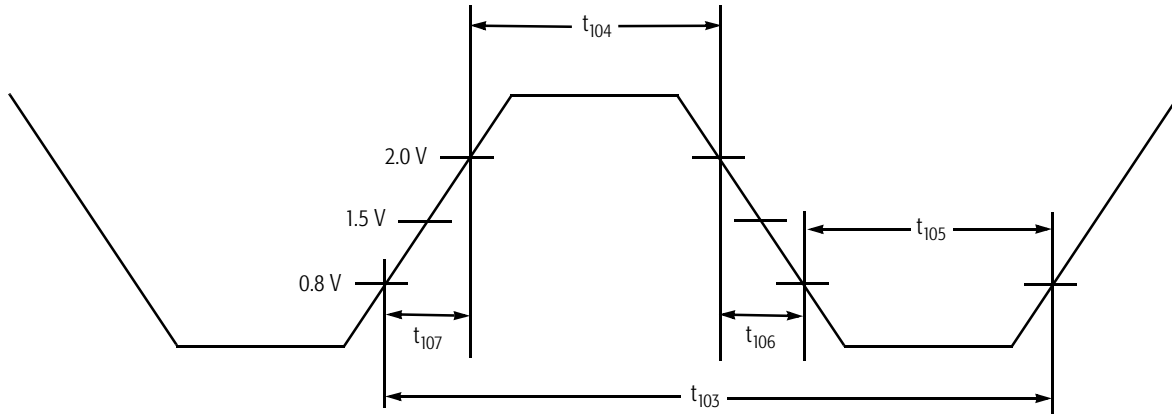

Figure 88. TCK Waveform

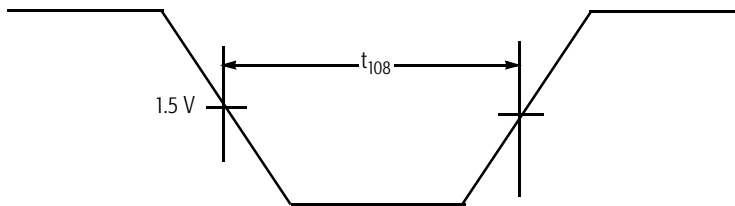

Figure 89. TRST# Timing

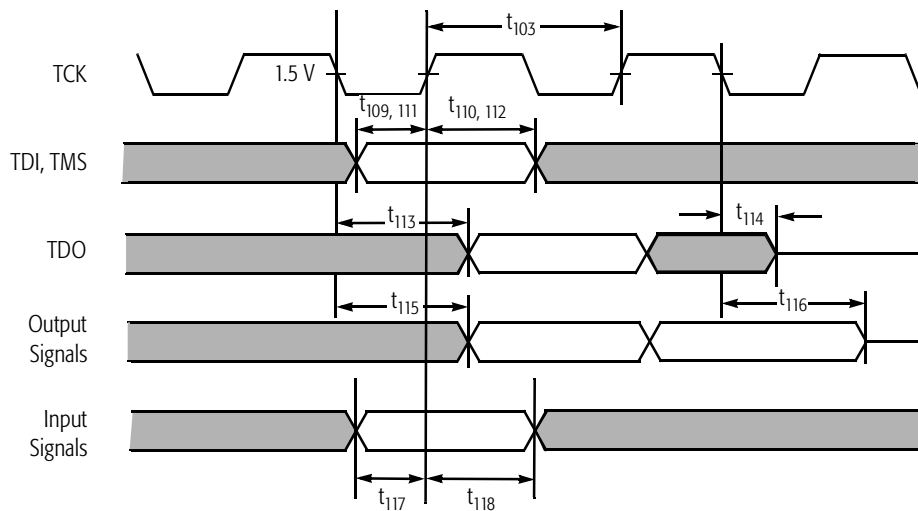

Figure 90. Test Signal Timing Diagram

17 Thermal Design

17.1 Package Thermal Specifications

The AMD-K6 processor operating specification calls for the case temperature (T_C) to be in the range of 0°C to 70°C. The ambient temperature (T_A) is not specified as long as the case temperature is not violated. The case temperature must be measured on the top center of the package. Table 56 shows the AMD-K6 processor thermal specifications.

Table 56. Package Thermal Specification

T _C Case Temperature	θ_{JC} Junction-Case	Maximum Thermal Power		
		2.9V Component		3.2V Component
		166 MHz	200MHz	233MHz
0°C–70°C	0.77°C/W	17.2 W	20.0 W	28.3 W
Stop Grant Mode		1.45 W	1.53 W	1.75 W
Stop Clock Mode		1.0 W	1.0 W	1.0 W

Figure 91 on page 260 shows the thermal model of a processor with a passive thermal solution. The case-to-ambient temperature (T_{CA}) can be calculated from the following equation:

$$\begin{aligned}
 T_{CA} &= P_{MAX} \cdot \theta_{CA} \\
 &= P_{MAX} \cdot (\theta_{IF} + \theta_{SA})
 \end{aligned}$$

Where:

- P_{MAX} = Maximum Power Consumption
- θ_{CA} = Case-to-Ambient Thermal Resistance
- θ_{IF} = Interface Material Thermal Resistance
- θ_{SA} = Sink-to-Ambient Thermal Resistance

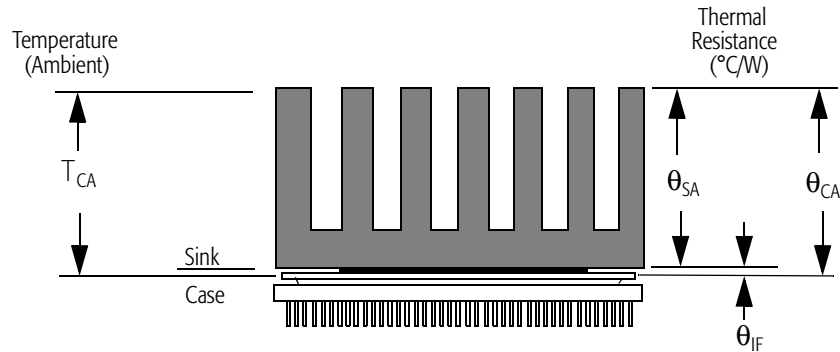

Figure 91. Thermal Model

Figure 92 illustrates the case-to-ambient temperature (T_{CA}) in relation to the power consumption (X-axis) and the thermal resistance (Y-axis). If the power consumption and case temperature are known, the thermal resistance (θ_{CA}) requirement can be calculated for a given ambient temperature (T_A) value.

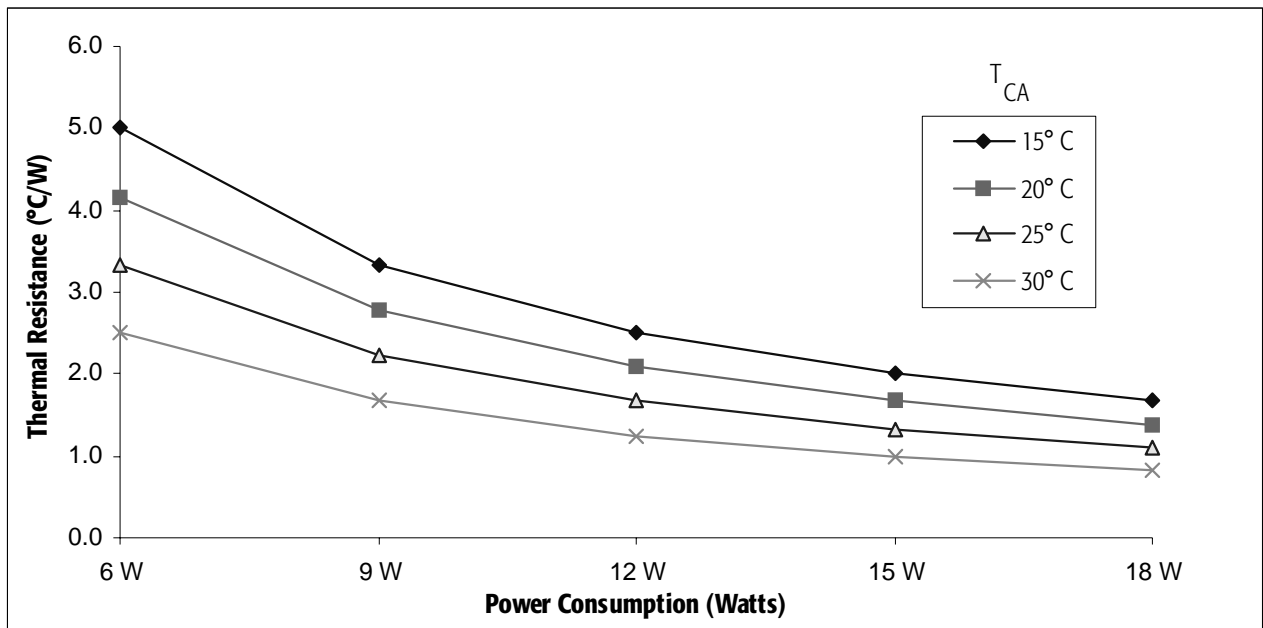

Figure 92. Power Consumption vs. Thermal Resistance

The following example calculates the required thermal resistance of a heatsink:

If:

$$T_C = 70^\circ\text{C}$$

$$T_A = 45^\circ\text{C}$$

$$P_{\text{MAX}} = 20.0\text{W at } 200\text{MHz}$$

Then:

$$\theta_{\text{CA}} \leq \left(\frac{T_C - T_A}{P_{\text{MAX}}} \right) = \frac{25^\circ\text{C}}{20.0\text{W}} = 1.25 \text{ (}^\circ\text{C/W)}$$

Thermal grease is recommended as interface material because it provides the lowest thermal resistance ($\cong 0.20^\circ\text{C/W}$). The required thermal resistance (θ_{SA}) of the heatsink in this example is calculated as follows:

$$\theta_{\text{SA}} = \theta_{\text{CA}} - \theta_{\text{IF}} = 1.25 - 0.20 = 1.05 \text{ (}^\circ\text{C/W)}$$

Heat Dissipation Path

Figure 93 illustrates the processor's heat dissipation path. Most of the heat generated by the processor is dissipated from the top surface (ceramic and lid) of the package. The small amount of heat generated from the bottom side of the processor where the processor socket blocks the convection can be safely ignored.

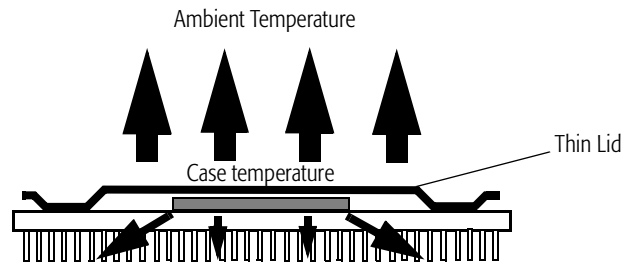

Figure 93. Processor Heat Dissipation Path

Measuring Case Temperature

The case temperature must be measured on the top center of the package where most of the heat is dissipated. Figure 94 shows the correct location for measuring the case temperature. (If a heat exchange device is installed, the thermocouple must contact the processor top surface through a drilled hole.) The case temperature is measured to ensure that the thermal solution meets the operational specification.

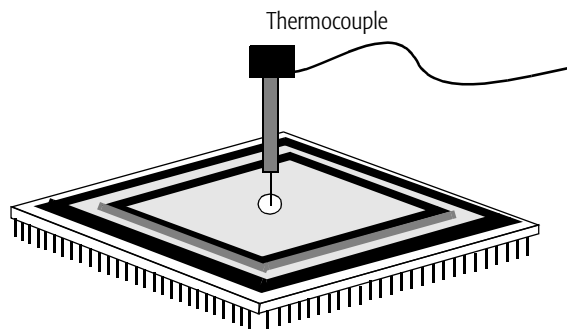

Figure 94. Measuring Case Temperature

17.2 Layout and Airflow Considerations

Voltage Regulator

A voltage regulator is required to support the lower voltage (3.3 V and lower) to the processor. In most applications, the voltage regulator is designed with power transistors. As a result, additional heatsinks are required to dissipate the heat from the power transistors. Figure 95 shows the voltage regulator placed parallel to the processor with the airflow aligned with the devices. With this alignment, the heat generated by the voltage regulator has minimal effect on the processor.

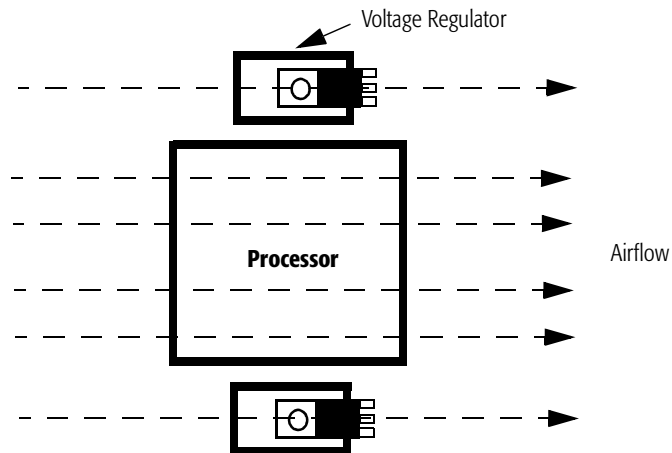

Figure 95. Voltage Regulator Placement

A heatsink and fan combination can deliver much better thermal performance than a heatsink alone. More importantly, with a fan/sink the airflow requirements in a system design are not as critical. A unidirectional heatsink with a fan moves air from the top of the heatsink to the side. In this case, the best location for the voltage regulator is on the side of the processor in the path of the airflow exiting the fan sink (see Figure 96). This location guarantees that the heatsinks on both the processor and the regulator receive adequate air circulation.

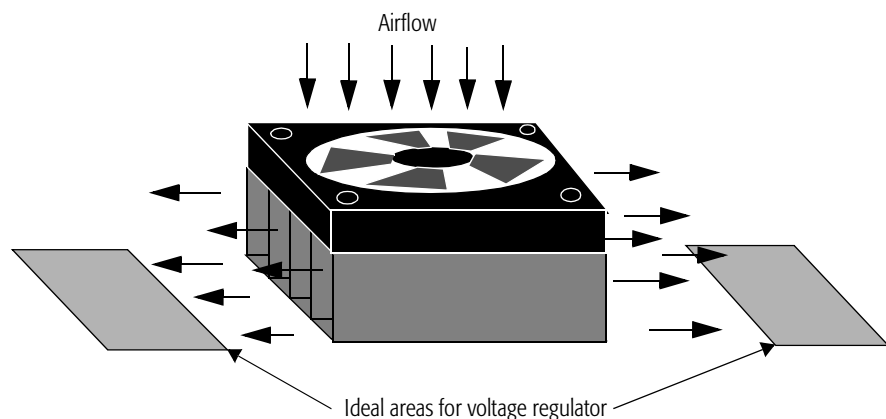

Figure 96. Airflow for a Heatsink with Fan

Airflow Management in a System Design

Complete airflow management in a system is important. In addition to the volume of air, the path of the air is also important. Figure 97 shows the airflow in a dual-fan system. The fan in the front end pulls cool air into the system through intake slots in the chassis. The power supply fan forces the hot air out of the chassis. The thermal performance of the heatsink can be maximized if it is located in the shaded area, where it receives greatest benefit from this air exchange system.

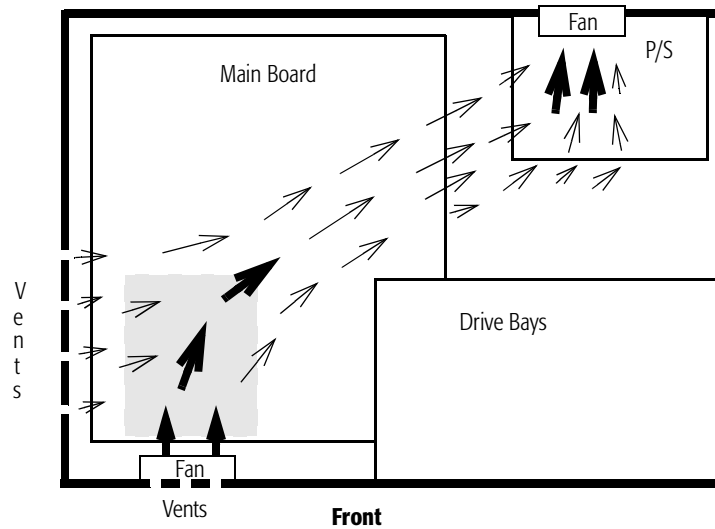

Figure 97. Airflow Path in a Dual-fan System

Figure 98 shows the airflow management in a system using the ATX form-factor. The orientation of the power supply fan and the motherboard are modified in the ATX platform design. The power supply fan pulls cool air through the chassis and across the processor. The processor is located near the power supply fan, where it can receive adequate airflow without an auxiliary fan. The arrangement significantly improves the airflow across the processor with minimum installation cost.

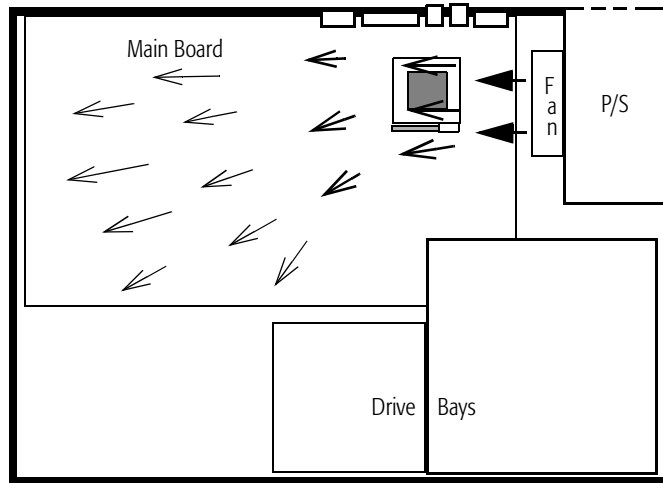

Figure 98. Airflow Path in an ATX Form-Factor System

For more information about thermal solutions, see the *AMD-K6[®] Processor Thermal Solution Design Application Note*, order# 21085.

18 Pin Description Diagram

- Control/Parity Pins
- ⊖ V_{SS} Pins
- ▲ V_{CC2} Pins
- △ V_{CC3} Pins
- Data Pins
- Address Pins
- T Test Pins
- ∅ NC, INC (Internal No Connect) Pins
- ⊗ RSVD (Reserved) Pins
- Chip Positioning Key Pin

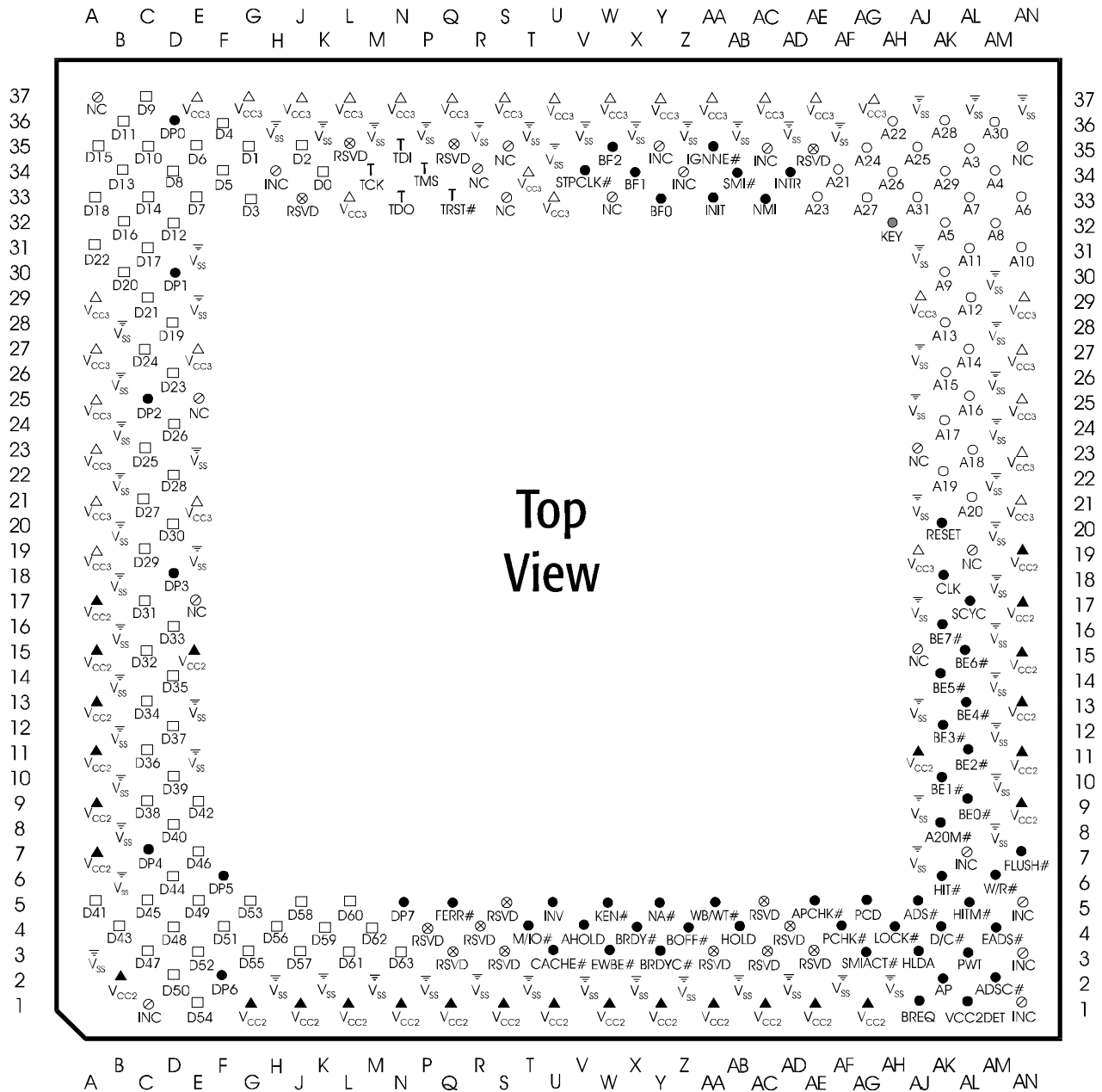

Figure 99. AMD-K6® Processor Top-Side View

- Control/Parity Pins
- Address Pins
- ⊖ V_{SS} Pins
- ⊕ Test Pins
- ▲ V_{CC2} Pins
- ⊙ NC, INC (Internal No Connect) Pins
- △ V_{CC3} Pins
- ⊗ RSVD (Reserved) Pins
- Data Pins
- Chip Positioning Key Pin

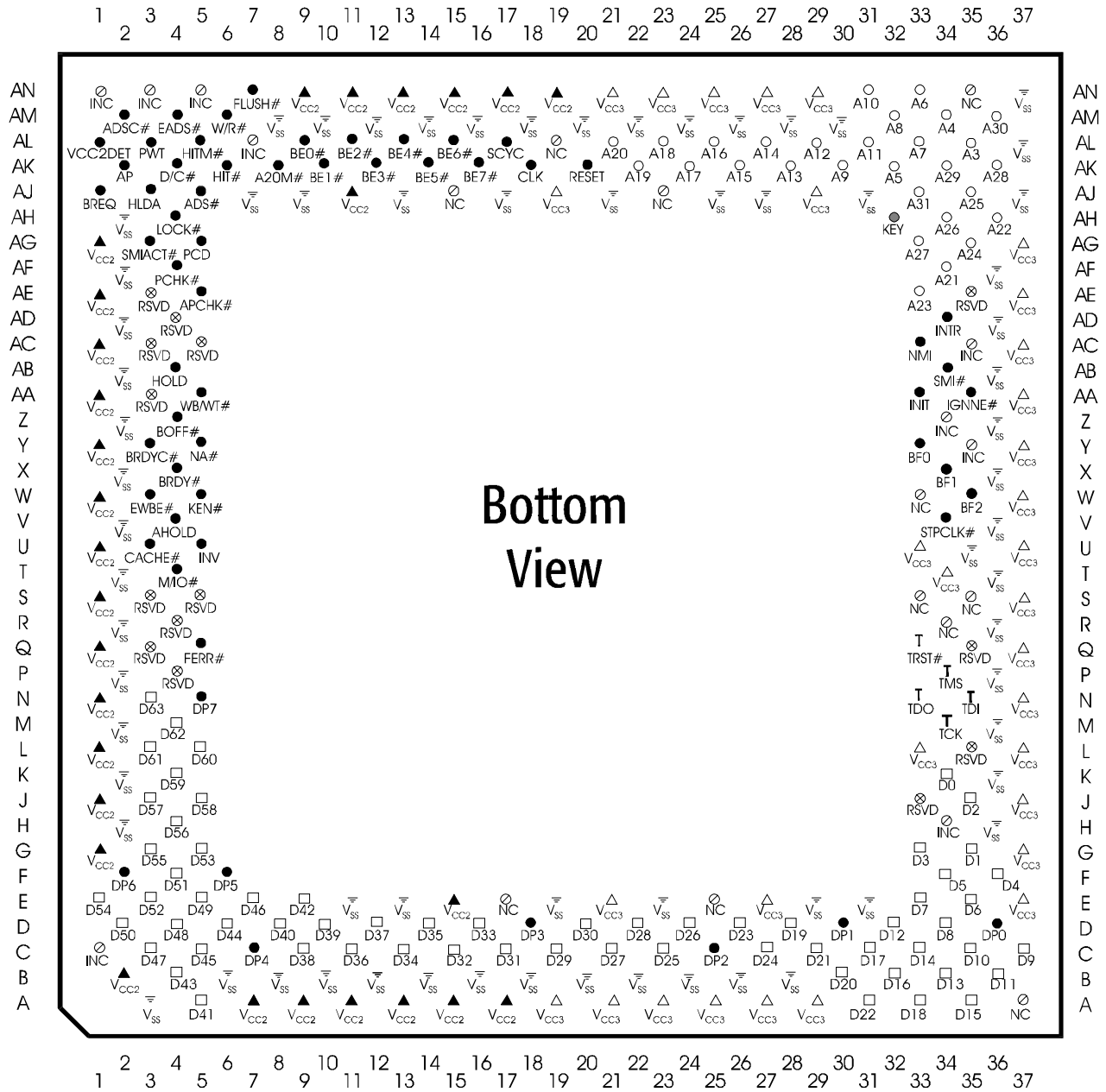

Figure 100. AMD-K6[®] Processor Pin-Side View

19 Pin Designations

AMD-K6[®] Processor Model 6 Functional Grouping

Address		Data		Control		Test		NC	V _{cc2}	V _{cc3}	V _{ss}	
Pin Name	Pin No.	Pin Name	Pin No.	Pin Name	Pin No.	Pin Name	Pin No.	Pin No.	Pin No.	Pin No.	Pin No.	
A3	AL-35	D0	K-34	A20M#	AK-08	TCK	M-34	A-37	A-07	A-19	A-03	AM-20
A4	AM-34	D1	G-35	ADS#	AJ-05	TDI	N-35	E-17	A-09	A-21	B-06	AM-22
A5	AK-32	D2	J-35	ADSC#	AM-02	TDO	N-33	E-25	A-11	A-23	B-08	AM-24
A6	AN-33	D3	G-33	AHOLD	V-04	TMS	P-34	R-34	A-13	A-25	B-10	AM-26
A7	AL-33	D4	F-36	APCHK#	AE-05	TRST#	Q-33	S-33	A-15	A-27	B-12	AM-28
A8	AM-32	D5	F-34	BE0#	AL-09			S-35	A-17	A-29	B-14	AM-30
A9	AK-30	D6	E-35	BE1#	AK-10			W-33	B-02	E-21	B-16	AN-37
A10	AN-31	D7	E-33	BE2#	AL-11			AJ-15	E-15	E-27	B-18	
A11	AL-31	D8	D-34	BE3#	AK-12			AJ-23	G-01	E-37	B-20	
A12	AL-29	D9	C-37	BE4#	AL-13			AL-19	J-01	G-37	B-22	
A13	AK-28	D10	C-35	BE5#	AK-14			AN-35	L-01	J-37	B-24	
A14	AL-27	D11	B-36	BE6#	AL-15				N-01	L-33	B-26	
A15	AK-26	D12	D-32	BE7#	AK-16				Q-01	L-37	B-28	
A16	AL-25	D13	B-34	BFO	Y-33				S-01	N-37	E-11	
A17	AK-24	D14	C-33	BF1	X-34				U-01	Q-37	E-13	
A18	AL-23	D15	A-35	BF2	W-35				W-01	S-37	E-19	
A19	AK-22	D16	B-32	BOFF#	Z-04				Y-01	T-34	E-23	
A20	AL-21	D17	C-31	BRDY#	X-04				AA-01	U-33	E-29	
A21	AF-34	D18	A-33	BRDYC#	Y-03				AC-01	U-37	E-31	
A22	AH-36	D19	D-28	BREQ	AJ-01				AE-01	W-37	H-02	
A23	AE-33	D20	B-30	CACHE#	U-03				AC-35	Y-37	H-36	
A24	AG-35	D21	C-29	CLK	AK-18				AL-07	AA-37	K-02	
A25	AJ-35	D22	A-31	D/C#	AK-04				AN-01	AN-09	K-36	
A26	AH-34	D23	D-26	EADS#	AM-04				AN-11	AE-37	M-02	
A27	AG-33	D24	C-27	EWBE#	W-03				AN-13	AG-37	M-36	
A28	AK-36	D25	C-23	FERR#	Q-05				AN-15	AJ-19	P-02	
A29	AK-34	D26	D-24	FLUSH#	AN-07				AN-17	AJ-29	P-36	
A30	AM-36	D27	C-21	HIT#	AK-06				AN-19	AN-21	R-02	
A31	AJ-33	D28	D-22	HITM#	AL-05					AN-23	R-36	
		D29	C-19	HLDA	AJ-03					AN-25	T-02	
		D30	D-20	HOLD	AB-04				J-33	AN-27	T-36	
		D31	C-17	IGNNE#	AA-35				L-35	AN-29	U-35	
		D32	C-15	INIT	AA-33				P-04		V-02	
		D33	D-16	INTR	AD-34				Q-03		V-36	
		D34	C-13	INV	U-05				Q-35		X-02	
		D35	D-14	KEN#	W-05				R-04		X-36	
		D36	C-11	LOCK#	AH-04				S-03		Z-02	
		D37	D-12	M/IO#	T-04				S-05		Z-36	
		D38	C-09	NA#	Y-05				AA-03		AB-02	
		D39	D-10	NMI	AC-33				AC-03		AB-36	
		D40	D-08	PCD	AG-05				AC-05		AD-02	
		D41	A-05	PCHK#	AF-04				AD-04		AD-36	
		D42	E-09	PWT	AL-03				AE-03		AF-02	
		D43	B-04	RESET	AK-20				AE-35		AF-36	
		D44	D-06	SCYC	AL-17						AH-02	
		D45	C-05	SMI#	AB-34						AJ-07	
		D46	E-07	SMIACT#	AG-03						AJ-09	
		D47	C-03	STPCLK#	V-34						AJ-13	
		D48	D-04	VCC2DET	AL-01						AJ-17	
		D49	E-05	W/R#	AM-06				AH-32		AJ-21	
		D50	D-02	WB/WT#	AA-05						AJ-25	
		D51	F-04								AJ-27	
		D52	E-03								AJ-31	
		D53	G-05								AJ-37	
		D54	E-01								AL-37	
		D55	G-03								AM-08	
		D56	H-04								AM-10	
		D57	J-03								AM-12	
		D58	J-05								AM-14	
		D59	K-04								AM-16	
		D60	L-05								AM-18	
		D61	L-03									
		D62	M-04									
		D63	N-03									

20 Package Specifications

20.1 321-Pin Staggered CPGA Package Specification

Table 57. 321-Pin Staggered CPGA Package Specification

Symbol	Millimeters			Inches		
	Min	Max	Notes	Min	Max	Notes
A	49.28	49.78		1.940	1.960	
B	45.59	45.85		1.795	1.805	
C	31.32	32.59		1.233	1.283	
D	44.90	45.10		1.768	1.776	
E	2.91	3.63		0.115	0.143	
F	1.30	1.52		0.051	0.060	
G	3.05	3.30		0.120	0.130	
H	0.43	0.51		0.017	0.020	
M	2.29	2.79		0.090	0.110	
N	1.14	1.40		0.045	0.055	
d	1.52	2.29		0.060	0.090	
e	1.52	2.54		0.060	0.100	
f	—	0.13	Flatness	—	0.005	Flatness

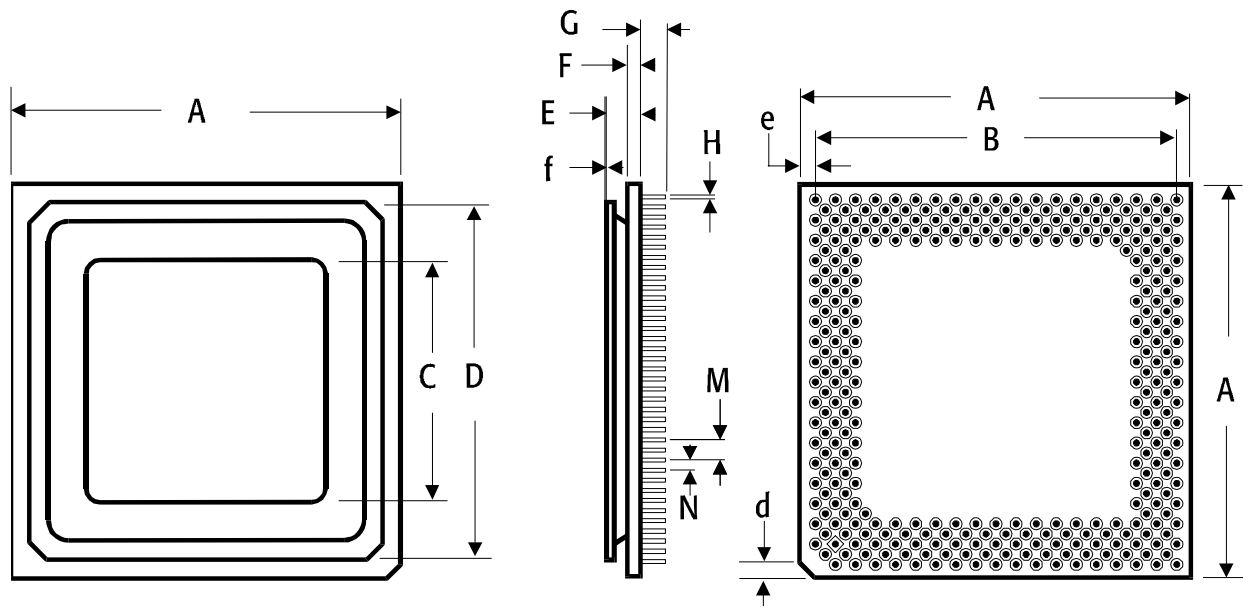

Figure 101. 321-Pin Staggered CPGA Package Specification

21 Ordering Information

Standard Products

AMD standard products are available in several operating ranges. The ordering part number (OPN) is formed by a combination of the elements below.

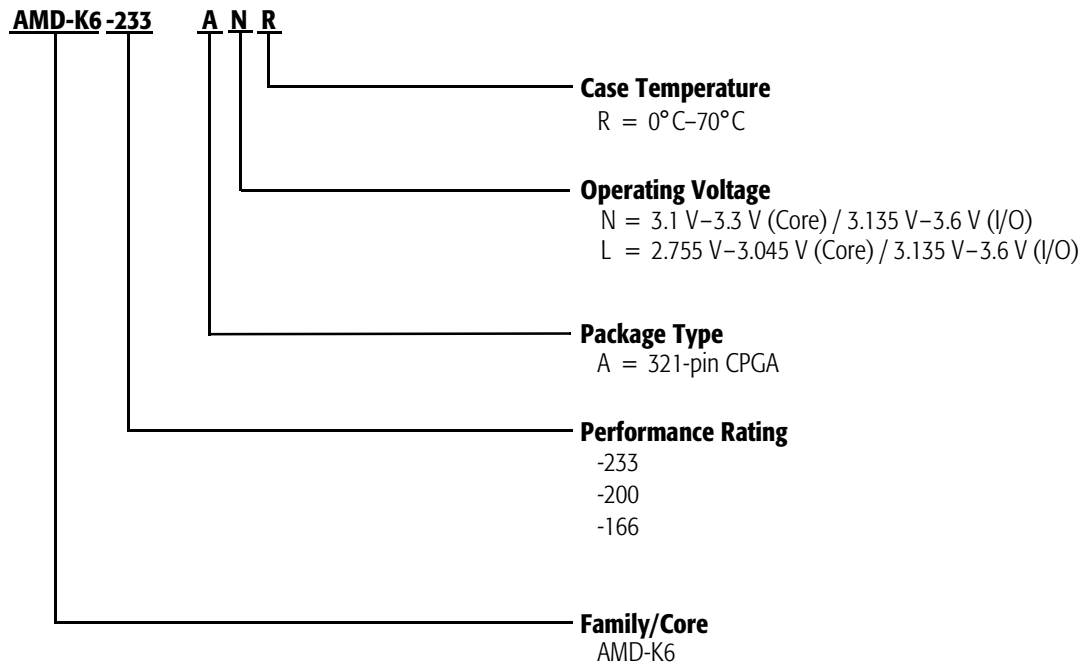

Table 58. Valid Ordering Part Number Combinations

OPN	Package Type	Operating Voltage	Case Temperature
AMD-K6-233ANR	321-pin CPGA	3.1V–3.3V (Core) 3.135V–3.6V (I/O)	0°C–70°C
AMD-K6-200ALR	321-pin CPGA	2.755V–3.045V (Core) 3.135V–3.6V (I/O)	0°C–70°C
AMD-K6-166ALR	321-pin CPGA	2.755V–3.045V (Core) 3.135V–3.6V (I/O)	0°C–70°C

Notes:

This table lists configurations planned to be supported in volume for this device. Consult the local AMD sales office to confirm availability of specific valid combinations and to check on newly-released combinations.

Part Two

AMD-K6[®] Processor Model 7

The AMD-K6[®] Processor Data Sheet supports the Model 6 and Model 7 versions of the AMD-K6 processor family. Model 6 refers to the AMD-K6 manufactured with 0.35-micron process technology and Model 7 refers to the AMD-K6 manufactured with 0.25-micron process technology. Part Two (chapters 22–42) contains information regarding new specifications and differences that pertain only to Model 7 as compared to Model 6.

22 AMD-K6[®] Processor

- Advanced 6-Issue RISC86[®] Superscalar Microarchitecture
 - ◆ Seven parallel specialized execution units
 - ◆ Multiple sophisticated x86-to-RISC86 instruction decoders
 - ◆ Advanced two-level branch prediction
 - ◆ Speculative execution
 - ◆ Out-of-order execution
 - ◆ Register renaming and data forwarding
 - ◆ Issues up to six RISC86 instructions per clock
- Large On-Chip Split 64-Kbyte Level-One (L1) Cache
 - ◆ 32-Kbyte instruction cache with additional predecode cache
 - ◆ 32-Kbyte writeback dual-ported data cache
 - ◆ MESI protocol support
- High-Performance IEEE 754-Compatible and 854-Compatible Floating-Point Unit
- High-Performance Industry-Standard MMX[™] Instructions
- 321-Pin Ceramic Pin Grid Array (CPGA) Package (Socket 7 Compatible)
- Industry-Standard System Management Mode (SMM)
- IEEE 1149.1 Boundary Scan
- Full x86 Binary Software Compatibility
- 0.25-Micron Process Technology

AMD continues to deliver leading-edge processor solutions by advancing the highly successful AMD-K6[®] processor with state-of-the-art 0.25-micron process technology. The AMD-developed 0.25-micron process technology enables the AMD-K6 processor to deliver higher performance with a lower core voltage and lower power dissipation. This new version of the AMD-K6 processor continues to leverage today's cost-effective infrastructure to deliver a superior price/performance PC solution.

To provide industry-leading performance, the AMD-K6 processor incorporates the innovative and efficient RISC86 microarchitecture, a large 64-Kbyte level-one cache (32-Kbyte dual-ported data cache, 32-Kbyte instruction cache with predecode data), a powerful IEEE 754-compatible and 854-compatible floating-point execution unit, and a high-performance multimedia execution unit for executing industry-standard MMX instructions. These features have been combined to deliver industry leadership in 16-bit and 32-bit performance, providing exceptional performance for both Windows[®] 95 and Windows NT[™] software bases.

The AMD-K6 processor's RISC86 microarchitecture is a decoupled decode/execution superscalar design that implements state-of-the-art design techniques to achieve leading-edge performance. Advanced design techniques implemented in the AMD-K6 include multiple x86 instruction decode, single-clock internal RISC operations, seven execution units that support superscalar operation, out-of-order execution, data forwarding, speculative execution, and register renaming. In addition, the processor supports the industry's most advanced branch prediction logic by implementing an 8192-entry branch history table, the industry's only branch target cache, and a return address stack, which combine to deliver better than a 95% prediction rate. These design techniques enable the AMD-K6 processor to issue, execute, and retire multiple x86 instructions per clock, resulting in excellent scaleable performance.

The AMD-K6 processor is fully x86 binary code compatible. AMD's extensive experience through four generations of x86 processors has been carefully integrated into the AMD-K6 to provide complete compatibility with Windows 95, Windows 3.x, Windows NT, DOS, OS/2, Unix, Solaris, NetWare[®], Vines, and other leading x86 operating systems and applications. The AMD-K6 processor is Socket 7 compatible, allowing the processor to be quickly and easily integrated into a mature and cost-effective industry-standard infrastructure of motherboards, chipsets, power supplies, and thermal designs.

AMD has designed, manufactured, and delivered over 50 million Microsoft Windows-compatible processors in the last five years alone. The AMD-K6 processor is the next addition to this long line of processors. With its combination of state-of-the-art features, industry-leading performance, high-performance multimedia engine, full x86 compatibility, and low-cost infrastructure, the AMD-K6 is the superior choice for mainstream personal computers.

23 Internal Architecture

The internal architecture of the AMD-K6 processor remains unchanged with the integration of 0.25-micron process technology. For information about the internal architecture of the AMD-K6 processor Model 7, see Chapter 2, “Internal Architecture” on page 7.

24 Software Environment

This chapter briefly describes the AMD-K6 Model-Specific Registers (MSRs) and x86 instructions supported by the AMD-K6 processor Model 7 that are not supported by the AMD-K6 processor Model 6.

For an overview of the AMD-K6 processor's x86 software environment and a description of the remaining data types, registers, operating modes, interrupts, and instructions supported by the AMD-K6 architecture and design implementation, see Chapter 3, "Software Environment" on page 21.

24.1 Registers

The AMD-K6 processor contains all the registers defined by the x86 architecture, including general-purpose, segment, floating-point, MMX, EFLAGS, control, task, debug, test, and descriptor/memory-management registers.

This section provides information on the Model-Specific Registers (MSRs) supported by the AMD-K6 processor Model 7 that are not supported by the AMD-K6 processor Model 6. For information about the remaining AMD-K6 registers, see Chapter 3, "Software Environment" on page 21.

Note: Areas of the register designated as Reserved should not be modified by software.

Model-Specific Registers (MSR)

The AMD-K6 processor Model 7 supports two additional MSRs as compared to the AMD-K6 processor Model 6. The value in the ECX register selects the MSR to be addressed by the RDMSR and WRMSR instructions. The values in EAX and EDX are used as inputs and outputs by the RDMSR and WRMSR instructions. Table 59 lists the new MSRs and the corresponding value of the ECX register. Figures 102 and 103 show the MSR formats.

Table 59. Model-Specific Registers (MSRs)

Model-Specific Register	Value of ECX
Extended Feature Enable Register (EFER)	C000_0080h
SYSCALL/SYSRET Target Address Register (STAR)	C000_0081h

For more information about the RDMSR and WRMSR instructions, see the *AMD K86™ Family BIOS and Software Tools Development Guide*, order# 21062.

Extended Feature Enable Register (EFER). The Extended Feature Enable Register (EFER) contains the control bits that enable the extended features of the AMD-K6. Figure 102 shows the format of the EFER register, and Table 60 defines the function of each bit in the EFER register.

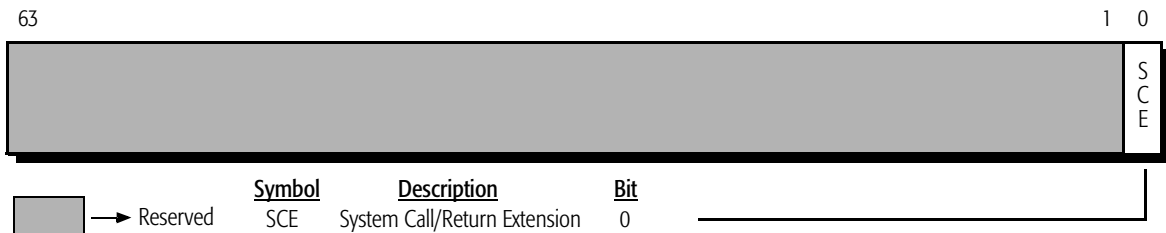

Figure 102. Extended Feature Enable Register (EFER)

Table 60. Extended Feature Enable Register (EFER) Definition

Bit	Description	R/W
63-1	Reserved	R
0	System Call/Return Extension (SCE)	R/W

SYSCALL/SYSRET Target Address Register (STAR).

The SYSCALL/SYSRET Target Address Register (STAR) contains the target EIP address used by the SYSCALL instruction and the 16-bit code and stack segment selector bases used by the SYSCALL and SYSRET instructions. Figure 103 shows the format of the STAR register, and Table 61 defines the function of each bit of the STAR register. For more information, see the *SYSCALL and SYSRET Instruction Specification Application Note*, order# 21086.

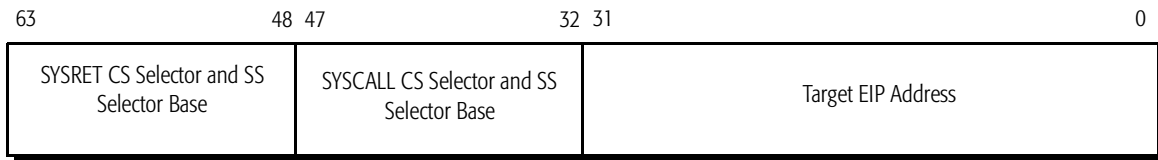
**Figure 103. SYSCALL/SYSRET Target Address Register (STAR)****Table 61. SYSCALL/SYSRET Target Address Register (STAR) Definition**

Bit	Description	R/W
63–48	SYSRET CS and SS Selector Base	R/W
47–32	SYSCALL CS and SS Selector Base	R/W
31–0	Target EIP Address	R/W

24.2 Instructions Supported by the AMD-K6[®] Processor

This section documents the x86 instructions supported by the AMD-K6 processor Model 7 that are not supported by AMD-K6 processor Model 6. For information about the remaining x86 instructions supported by the AMD-K6 processor Model 6, see Chapter 3, “Software Environment” on page 21.

Table 62 shows the instruction mnemonic, opcode, modR/M byte, decode type, and RISC86 operation(s) for each instruction. The first column of the tables indicates the instruction mnemonic and operand types. The second and third columns list all applicable opcode bytes. The fourth column lists the modR/M byte when used by the instruction. The modR/M byte defines the instruction as a register or memory form. The fifth column lists the type of instruction decode—short, long, and vector. The sixth column lists the type of RISC86 operation(s) required for the instruction.

Table 62. Integer Instructions

Instruction Mnemonic	First Byte	Second Byte	ModR/M Byte	Decode Type	RISC86 [®] Opcodes
SYSCALL	0Fh	05h		vector	
SYSRET	0Fh	07h		vector	

25 Logic Symbol Diagram

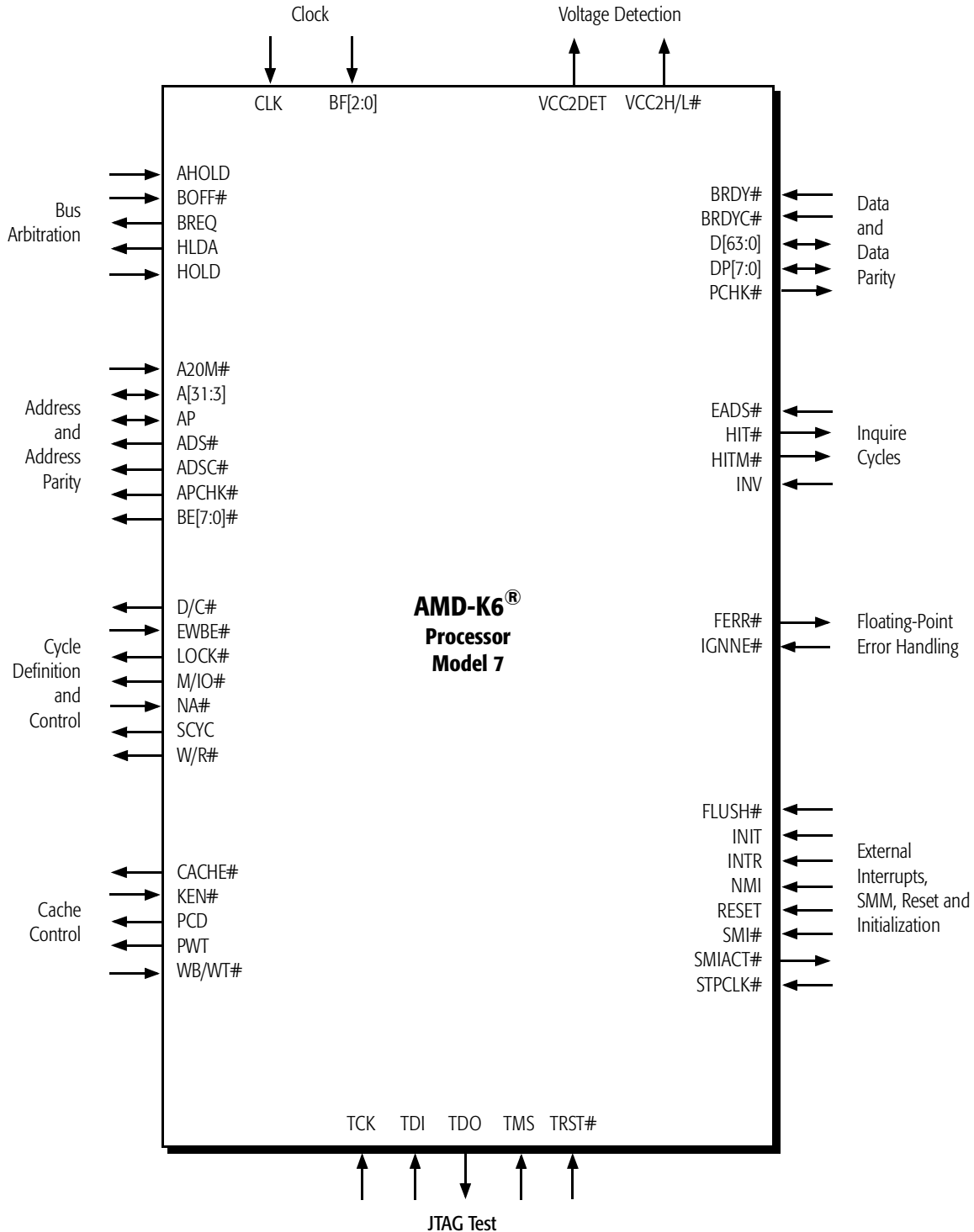

26 Signal Descriptions

This chapter provides a description of the signals designed to indicate to system logic the specified dual-voltage requirements of the AMD-K6 processor Model 7. For information about the remaining AMD-K6 processor Model 7 signals, see Chapter 5, “Signal Descriptions” on page 79.

26.1 VCC2DET (V_{CC2} Detect)

Output

Summary

VCC2DET is internally tied to V_{SS} (logic level 0) to indicate to the system logic that it must supply the specified dual-voltage requirements to the V_{CC2} and V_{CC3} pins. The V_{CC2} pins supply voltage to the processor core, independent of the voltage supplied to the I/O buffers on the V_{CC3} pins. Upon sampling VCC2DET Low, system logic should sample VCC2H/L# to identify core voltage requirements.

Driven

VCC2DET always equals 0 and is never floated—even during Tri-State Test mode.

26.2 VCC2H/L# (V_{CC2} High/Low)

Output

Summary

VCC2H/L# is internally tied to V_{SS} (logic level 0) to indicate to the system logic that it must supply the specified processor core voltage to the V_{CC2} pins. The V_{CC2} pins supply voltage to the processor core, independent of the voltage supplied to the I/O buffers on the V_{CC3} pins. Upon sampling VCC2DET Low to identify dual-voltage processor requirements, system logic should sample VCC2H/L# to identify the core voltage requirements for 2.9V and 3.2V products (High) and 2.2V products (Low).

Driven

VCC2H/L# always equals 0 and is never floated for 2.2V products—even during Tri-State Test mode. To ensure proper

operation for 2.9V and 3.2V products, system logic that samples VCC2H/L# should design a weak pullup resistor for this signal.

Table 63. Output Pin Float Conditions

Name	Floated At:	Note
VCC2DET	Always Driven	*
VCC2H/L#	Always Driven	*
Notes: * All outputs except VCC2DET, VCC2H/L#, and TDO float during Tri-State Test mode.		

27 Bus Cycles

The timing and relationship of bus signals for the AMD-K6 processor remain unchanged with the integration of 0.25-micron process technology. For information about bus cycles for the AMD-K6 processor Model 7, see Chapter 6, “Bus Cycles” on page 121.

28 Power-on Configuration and Initialization

This chapter provides information on the power-on configuration and initialization states of the AMD-K6 processor Model 7 that differ from the states of the AMD-K6 processor Model 6. For more information about the power-on configuration and initialization states of the AMD-K6 processor Model 7, see Chapter 7, “Power-on Configuration and Initialization” on page 167.

28.1 State of Processor After RESET

Output Signals

Table 64 shows the state of processor outputs immediately after RESET is sampled asserted. The processor outputs shown are those supported by the AMD-K6 processor Model 7 that are not supported by the outputs of the AMD-K6 processor Model 6. For information about the state of the remaining processor outputs after RESET for the AMD-K6 processor Model 7, see Chapter 7, “Power-on Configuration and Initialization” on page 167.

Table 64. Output Signal State After RESET

Signal	State
VCC2H/L#	Low

Table 65 on page 292 shows the state of the architecture register EDX and the Model-Specific Registers EFER and STAR after the processor has completed its initialization due to the recognition of RESET. EDX is supported in both the AMD-K6 processor Model 7 and AMD-K6 processor Model 6. EFER and STAR are supported only in the AMD-K6 processor Model 7.

Table 65. Register State After RESET

Register	State (Hex)	Notes
EDX	0000_057Xh	1
EFER	0000_0000_0000_0000h	2
STAR	0000_0000_0000_0000h	2

Notes:

1. EDX contains the AMD-K6 processor signature, where X indicates the processor Stepping ID.
2. The contents of these registers are preserved following the recognition of INIT.

29 Cache Organization

The internal cache organization of the AMD-K6 processor remains unchanged with the integration of 0.25-micron process technology. For information about the cache organization of the AMD-K6 processor Model 7, see Chapter 8, “Cache Organization” on page 171.

30 Floating-Point and Multimedia Execution Units

The floating-point and multimedia execution units of the AMD-K6 processor remain unchanged with the integration of 0.25-micron process technology. For information about the floating-point and multimedia execution units of the AMD-K6 processor Model 7, see Chapter 9, “Floating-Point and Multimedia Execution Units” on page 189.

31 System Management Mode (SMM)

The implementation of SMM in the AMD-K6 processor remains unchanged with the integration of 0.25-micron process technology. For information about the implementation of SMM in the AMD-K6 processor Model 7, see Chapter 10, “System Management Mode (SMM)” on page 193.

32 Test and Debug

The AMD-K6 processor implements various test and debug modes to enable the functional and manufacturing testing of systems and boards that use the processor. In addition, the debug features of the processor allow designers to debug the instruction execution of software components. This chapter describes the following test and debug features of the AMD-K6 processor Model 7 that differ from those supported by the AMD-K6 processor Model 6:

- *Tri-State Test Mode*—A test mode that causes the processor to float its output and bidirectional pins.
- *Boundary-Scan Test Access Port (TAP)*—The Joint Test Action Group (JTAG) test access function defined by the *IEEE Standard Test Access Port and Boundary-Scan Architecture (IEEE 1149.1-1990)* specification.

For more information about the test and debug modes of the AMD-K6 processor Model 7, see Chapter 11, “Test and Debug” on page 203.

32.1 Tri-State Test Mode

The VCC2DET, VCC2H/L#, and TDO signals are the only outputs not floated in the Tri-State Test mode. VCC2DET and VCC2H/L# must remain Low to ensure the system continues to supply the specified processor core voltage to the V_{CC2} pins. TDO is never floated because the Boundary-Scan Test Access Port must remain enabled at all times, including during the Tri-State Test mode.

The Tri-State Test mode is exited when the processor samples RESET asserted.

32.2 Boundary-Scan Test Access Port (TAP)

The boundary-scan Test Access Port (TAP) is an IEEE standard that defines synchronous scanning test methods for complex logic circuits, such as boards containing a processor. The AMD-K6 processor supports the TAP standard defined in the

IEEE Standard Test Access Port and Boundary-Scan Architecture (IEEE 1149.1-1990) specification.

TAP Registers

Device Identification Register (DIR). The DIR is a 32-bit Test Data Register selected during the execution of the IDCODE instruction. The fields of the DIR and their values are shown in Table 66 and are defined as follows:

- *Version Code*—This 4-bit field is incremented by AMD manufacturing for each major revision of silicon.
- *Part Number*—This 16-bit field identifies the specific processor model.
- *Manufacturer*—This 11-bit field identifies the manufacturer of the component (AMD).
- *LSB*—The least significant bit (LSB) of the DIR is always set to 1, as specified by the IEEE 1149.1 standard.

Table 66. Device Identification Register

Version Code (Bits 31–28)	Part Number (Bits 27–12)	Manufacturer (Bits 11–1)	LSB (Bit 0)
Xh	0570h	00000000001b	1b

33 Clock Control

The clock control modes of the AMD-K6 processor remain unchanged with the integration of 0.25-micron process technology. For information about the clock control modes of the AMD-K6 processor Model 7, see Chapter 12, “Clock Control” on page 223.

34 Power and Grounding

The fundamental power and ground requirements of the AMD-K6 processor remain unchanged with the integration of 0.25-micron process technology. For information about decoupling recommendations and pin connection requirements of the AMD-K6 processor Model 7, see the *AMD-K6[®] Processor Power Supply Design Application Note*, order# 21103 and Chapter 13, “Power and Grounding” on page 229.

34.1 Power Connections

The AMD-K6 processor is a dual voltage device. Two separate supply voltages are required— V_{CC2} and V_{CC3} . V_{CC2} provides the core voltage for the processor and V_{CC3} provides the I/O voltage. See “Electrical Data” on page 233 for the value and range of V_{CC2} and V_{CC3} .

There are 28 V_{CC2} , 32 V_{CC3} , and 68 V_{SS} pins on the AMD-K6 processor. (See “Pin Designations” on page 269 for all power and ground pin designations.) The large number of power and ground pins are provided to ensure that the processor and package maintain a clean and stable power distribution network.

For more information about power connections requirements for the AMD-K6 processor Model 7, see Chapter 13, “Power and Grounding” on page 229.

35 Electrical Data

35.1 Operating Ranges

The functional operation of the AMD-K6 processor Model 7 is guaranteed if the voltage and temperature parameters are within the limits defined in Table 67.

Table 67. Operating Ranges

Parameter	Minimum	Typical	Maximum	Comments
V_{CC2}	2.1 V	2.2 V	2.3 V	Note 1, 2
V_{CC3}	3.135 V	3.30 V	3.6 V	Note 1
T_{CASE}	0°C		70°C	
Notes:				
1. V_{CC2} and V_{CC3} are referenced from V_{SS} .				
2. V_{CC2} specification for 2.2 V components.				

35.2 Absolute Ratings

Functional operation of the AMD-K6 processor Model 7 is not guaranteed beyond the operating ranges listed in Table 67. Exposure to conditions outside these operating ranges for extended periods of time can affect long-term reliability. Permanent damage can occur if the absolute ratings listed in Table 68 are exceeded.

Table 68. Absolute Ratings

Parameter	Minimum	Maximum	Comments
V_{CC2}	-0.5 V	2.5 V	
V_{CC3}	-0.5 V	3.6 V	
V_{PIN}	-0.5 V	$V_{CC3} + 0.5 V$ and $\leq 4.0 V$	Note
T_{CASE} (under bias)	-65°C	+110°C	
$T_{STORAGE}$	-65°C	+150°C	
Note:			
V_{PIN} (the voltage on any I/O pin) must not be greater than 0.5 V above the voltage being applied to V_{CC3} . In addition, the V_{PIN} voltage must never exceed 4.0 V.			

35.3 DC Characteristics

The DC characteristics of the AMD-K6 processor Model 7 are shown in Table 69.

Table 69. DC Characteristics

Symbol	Parameter Description	Preliminary Data		Comments
		Min	Max	
V_{IL}	Input Low Voltage	-0.3 V	+0.8 V	
V_{IH}	Input High Voltage	2.0 V	$V_{CC3} + 0.3 V$	Note 1
V_{OL}	Output Low Voltage		0.4 V	$I_{OL} = 4.0\text{-mA}$ load
V_{OH}	Output High Voltage	2.4 V		$I_{OH} = 3.0\text{-mA}$ load
I_{CC2}	2.2 V Power Supply Current		5.95 A	200 MHz, Note 2
			6.50 A	233 MHz, Note 2
			7.05 A	266 MHz, Note 2
			7.49 A	300 MHz, Note 2
I_{CC3}	3.3 V Power Supply Current		0.50 A	200 MHz, Note 3
			0.52 A	233 MHz, Note 3
			0.54 A	266 MHz, Note 3
			0.56 A	300 MHz, Note 3
I_{LI}	Input Leakage Current		$\pm 15 \mu A$	Note 4
I_{LO}	Output Leakage Current		$\pm 15 \mu A$	Note 4
I_{IL}	Input Leakage Current Bias with Pullup		-400 μA	Note 5
I_{IH}	Input Leakage Current Bias with Pulldown		200 μA	Note 6
C_{IN}	Input Capacitance		10 pF	
C_{OUT}	Output Capacitance		15 pF	
C_{OUT}	I/O Capacitance		20 pF	
C_{CLK}	CLK Capacitance		10 pF	
C_{TIN}	Test Input Capacitance (TDI, TMS, TRST#)		10 pF	
C_{TOUT}	Test Output Capacitance (TDO)		15 pF	
C_{TCK}	TCK Capacitance		10 pF	

Notes:

1. V_{CC3} refers to the voltage being applied to V_{CC3} during functional operation.
2. $V_{CC2} = 2.3 V$ – The maximum power supply current must be taken into account when designing a power supply.
3. $V_{CC3} = 3.6 V$ – The maximum power supply current must be taken into account when designing a power supply.
4. Refers to inputs and I/O without an internal pullup resistor and $0 \leq V_{IN} \leq V_{CC3}$.
5. Refers to inputs with an internal pullup and $V_{IL} = 0.4 V$.
6. Refers to inputs with an internal pulldown and $V_{IH} = 2.4 V$.

35.4 Power Dissipation

Table 70 contains the typical and maximum power dissipation of the AMD-K6 processor Model 7 during normal and reduced power states.

Table 70. Typical and Maximum Power Dissipation

Clock Control State	2.2 V Component				Comments
	200 MHz	233 MHz	266 MHz	300 MHz	
Normal (Maximum Thermal Power)	12.45 W	13.50 W	14.55 W	15.40 W	Note 1, 2
Normal (Typical Thermal Power)	7.50 W	8.10 W	8.75 W	9.25 W	Note 3
Stop Grant / Halt (Maximum)	2.44 W	2.46 W	2.48 W	2.50 W	Note 4
Stop Clock (Maximum)	2.25 W	2.25 W	2.25 W	2.25 W	Note 5

Notes:

1. The maximum power dissipated in the normal clock control state must be taken into account when designing a solution for thermal dissipation for the AMD-K6 processor.
2. Maximum power is determined for the worst-case instruction sequence or function for the listed clock control states with $V_{CC2} = 2.2$ V and $V_{CC3} = 3.3$ V.
3. Typical power is determined for the typical instruction sequences or functions associated with normal system operation with $V_{CC2} = 2.2$ V and $V_{CC3} = 3.3$ V.
4. The CLK signal and the internal PLL are still running but most internal clocking has stopped.
5. The CLK signal, the internal PLL, and all internal clocking has stopped.

36 I/O Buffer Characteristics

The I/O buffer characteristics of the AMD-K6 processor Model 7 are different from those of the AMD-K6 processor Model 6. These differences are minor and are reflected in the I/O Buffer IBIS Models that are developed for each processor. For the IBIS models and their application, refer to the *AMD-K6[®] Processor I/O Model Application Note*, order# 21084.

Despite these minor differences, the AC timing specifications and the DC specifications of the I/O buffers remain unchanged with the integration of 0.25-micron process technology. For additional information about the I/O buffer characteristics of the AMD-K6 processor Model 7, see Chapter 15, “I/O Buffer Characteristics” on page 237.

37 Signal Switching Characteristics

The signal switching characteristics of the AMD-K6 processor remain unchanged with the integration of 0.25-micron process technology. For information about the signal switching characteristics of the AMD-K6 processor Model 7, see Chapter 16, “Signal Switching Characteristics” on page 241.

38 Thermal Design

38.1 Package Thermal Specifications

The AMD-K6 processor Model 7 operating specification calls for the case temperature (T_C) to be in the range of 0°C to 70°C. The ambient temperature (T_A) is not specified as long as the case temperature is not violated. The case temperature must be measured on the top center of the package. Table 71 shows the AMD-K6 processor thermal specifications.

Table 71. Package Thermal Specification

T_C Case Temperature	θ_{JC} Junction-Case	Maximum Thermal Power			
		2.2 V Component			
		200 MHz	233 MHz	266 MHz	300 MHz
0°C–70°C	1.7 °C/W	12.45 W	13.50 W	14.55 W	15.40 W
Stop Grant Mode		2.44 W	2.46 W	2.48 W	2.50 W
Stop Clock Mode		2.25 W	2.25 W	2.25 W	2.25 W

For information about thermal solutions, see the AMD-K6[®] Processor Thermal Solution Design Application Note, order# 21085.

39 Pin Description Diagram

- Control/Parity Pins
- Address Pins
- ⊖ V_{SS} Pins
- ⊕ V_{CC2} Pins
- △ V_{CC3} Pins
- Data Pins
- Address Pins
- ⊕ Test Pins
- ∅ NC, INC (Internal No Connect) Pins
- ⊗ RSVD (Reserved) Pins
- Chip Positioning Key Pin

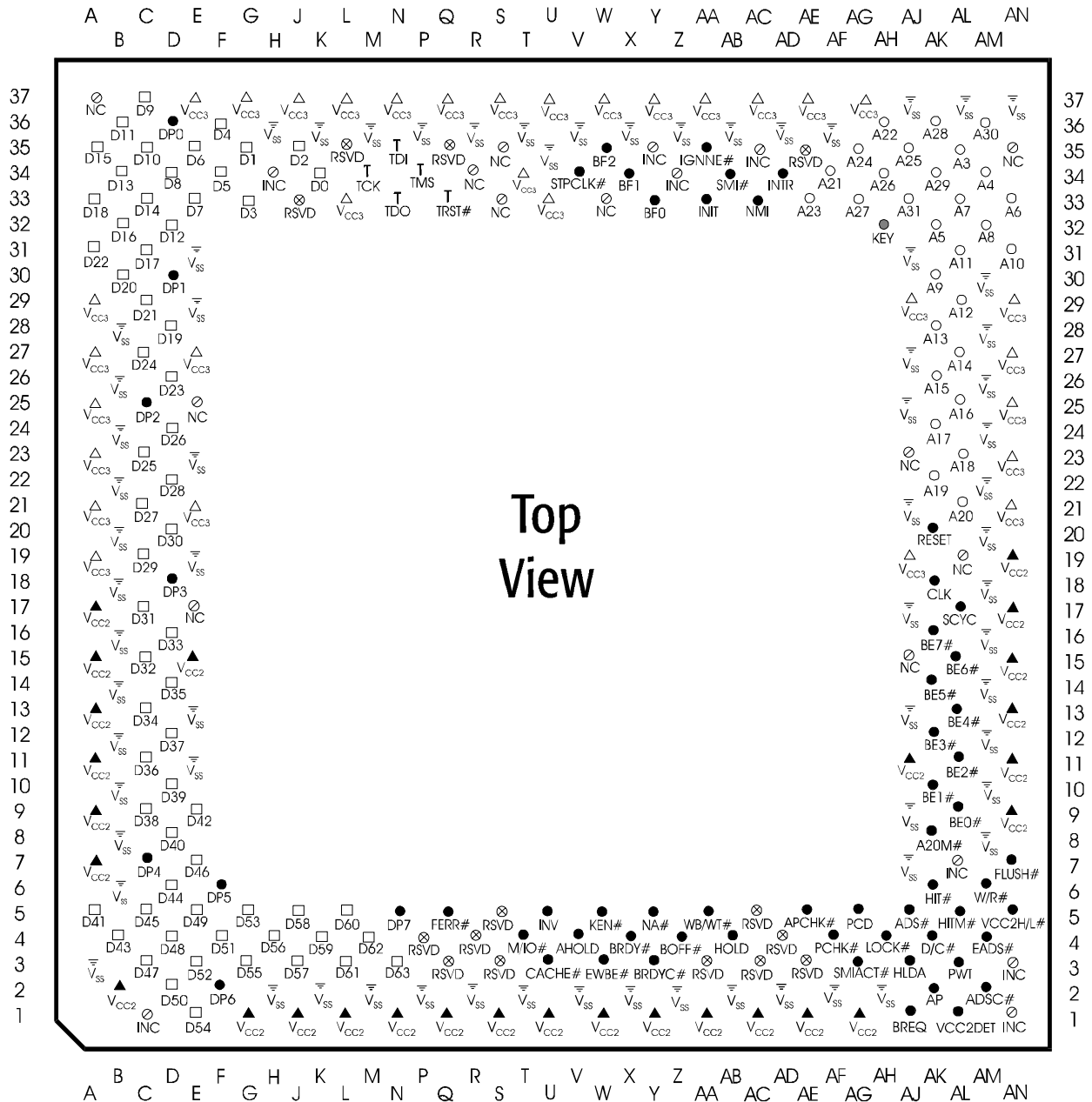

Figure 104. AMD-K6[®] Processor Model 7 Top-Side View

40 Pin Designations

AMD-K6® Processor Model 7 Functional Grouping

Address		Data		Control		Test		NC	V _{cc2}	V _{cc3}	V _{ss}	
Pin Name	Pin No.	Pin Name	Pin No.	Pin Name	Pin No.	Pin Name	Pin No.	Pin No.	Pin No.	Pin No.	Pin No.	
A3	AL-35	D0	K-34	A20M#	AK-08	TCK	M-34	A-37	A-07	A-19	A-03	AM-20
A4	AM-34	D1	G-35	ADS#	AJ-05	TDI	N-35	E-17	A-09	A-21	B-06	AM-22
A5	AK-32	D2	J-35	ADSC#	AM-02	TDO	N-33	E-25	A-11	A-23	B-08	AM-24
A6	AN-33	D3	G-33	AHOLD	V-04	TMS	P-34	R-34	A-13	A-25	B-10	AM-26
A7	AL-33	D4	F-36	APCHK#	AE-05	TRST#	Q-33	S-33	A-15	A-27	B-12	AM-28
A8	AM-32	D5	F-34	BE0#	AL-09			S-35	A-17	A-29	B-14	AM-30
A9	AK-30	D6	E-35	BE1#	AK-10			W-33	B-02	E-21	B-16	AN-37
A10	AN-31	D7	E-33	BE2#	AL-11			AJ-15	E-15	E-27	B-18	
A11	AL-31	D8	D-34	BE3#	AK-12			AJ-23	G-01	E-37	B-20	
A12	AL-29	D9	C-37	BE4#	AL-13			AL-19	J-01	G-37	B-22	
A13	AK-28	D10	C-35	BE5#	AK-14			AN-35	L-01	J-37	B-24	
A14	AL-27	D11	B-36	BE6#	AL-15				N-01	L-33	B-26	
A15	AK-26	D12	D-32	BE7#	AK-16				Q-01	L-37	B-28	
A16	AL-25	D13	B-34	BFO	Y-33				S-01	N-37	E-11	
A17	AK-24	D14	C-33	BF1	X-34				U-01	Q-37	E-13	
A18	AL-23	D15	A-35	BF2	W-35				W-01	S-37	E-19	
A19	AK-22	D16	B-32	BOFF#	Z-04				Y-01	T-34	E-23	
A20	AL-21	D17	C-31	BRDY#	X-04				AA-01	U-33	E-29	
A21	AF-34	D18	A-33	BRDYC#	Y-03				AC-01	U-37	E-31	
A22	AH-36	D19	D-28	BREQ	AJ-01				AE-01	W-37	H-02	
A23	AE-33	D20	B-30	CACHE#	U-03				AC-35	Y-37	H-36	
A24	AG-35	D21	C-29	CLK	AK-18				AL-07	AA-37	K-02	
A25	AJ-35	D22	A-31	D/C#	AK-04				AN-01	AN-09	K-36	
A26	AH-34	D23	D-26	EADS#	AM-04				AN-11	AE-37	M-02	
A27	AG-33	D24	C-27	EWBE#	W-03				AN-13	AG-37	M-36	
A28	AK-36	D25	C-23	FERR#	Q-05				AN-15	AJ-19	P-02	
A29	AK-34	D26	D-24	FLUSH#	AN-07				AN-17	AJ-29	P-36	
A30	AM-36	D27	C-21	HIT#	AK-06				AN-19	AN-21	R-02	
A31	AJ-33	D28	D-22	HITM#	AL-05					AN-23	R-36	
		D29	C-19	HLDA	AJ-03				J-33	AN-25	T-02	
		D30	D-20	HOLD	AB-04				L-35	AN-27	T-36	
		D31	C-17	IGNNE#	AA-35				P-04	AN-29	U-35	
		D32	C-15	INIT	AA-33				Q-03		V-02	
		D33	D-16	INTR	AD-34				Q-35		V-36	
		D34	C-13	INV	U-05				R-04		X-02	
		D35	D-14	KEN#	W-05				S-03		X-36	
		D36	C-11	LOCK#	AH-04				S-05		Z-02	
		D37	D-12	M/IO#	T-04				AA-03		Z-36	
		D38	C-09	NA#	Y-05				AC-03		AB-02	
		D39	D-10	NMI	AC-33				AC-05		AB-36	
		D40	D-08	PCD	AG-05				AD-04		AD-02	
		D41	A-05	PCHK#	AF-04				AE-03		AD-36	
		D42	E-09	PWT	AL-03				AE-35		AF-02	
		D43	B-04	RESET	AK-20						AF-36	
		D44	D-06	SCYC	AL-17						AH-02	
		D45	C-05	SMI#	AB-34						AJ-07	
		D46	E-07	SMIACT#	AG-03						AJ-09	
		D47	C-03	STPCLK#	V-34						AJ-13	
		D48	D-04	VCC2DET	AL-01						AJ-17	
		D49	E-05	VCC2H/L#	AN-05						AJ-21	
		D50	D-02	W/R#	AM-06						AJ-25	
		D51	F-04	WB/WT#	AA-05						AJ-27	
		D52	E-03								AJ-31	
		D53	G-05								AJ-37	
		D54	E-01								AL-37	
		D55	G-03								AM-08	
		D56	H-04								AM-10	
		D57	J-03								AM-12	
		D58	J-05								AM-14	
		D59	K-04								AM-16	
		D60	L-05								AM-18	
		D61	L-03									
		D62	M-04									
		D63	N-03									

41 Package Specifications

The package specifications for the AMD-K6 processor remain unchanged with the integration of 0.25-micron process technology. For information about the package specifications of the AMD-K6 processor Model 7, see Chapter 20, “Package Specifications” on page 271.

42 Ordering Information

Standard AMD-K6[®] Processor Model 7 Products

AMD standard products are available in several operating ranges. The ordering part number (OPN) is formed by a combination of the elements below.

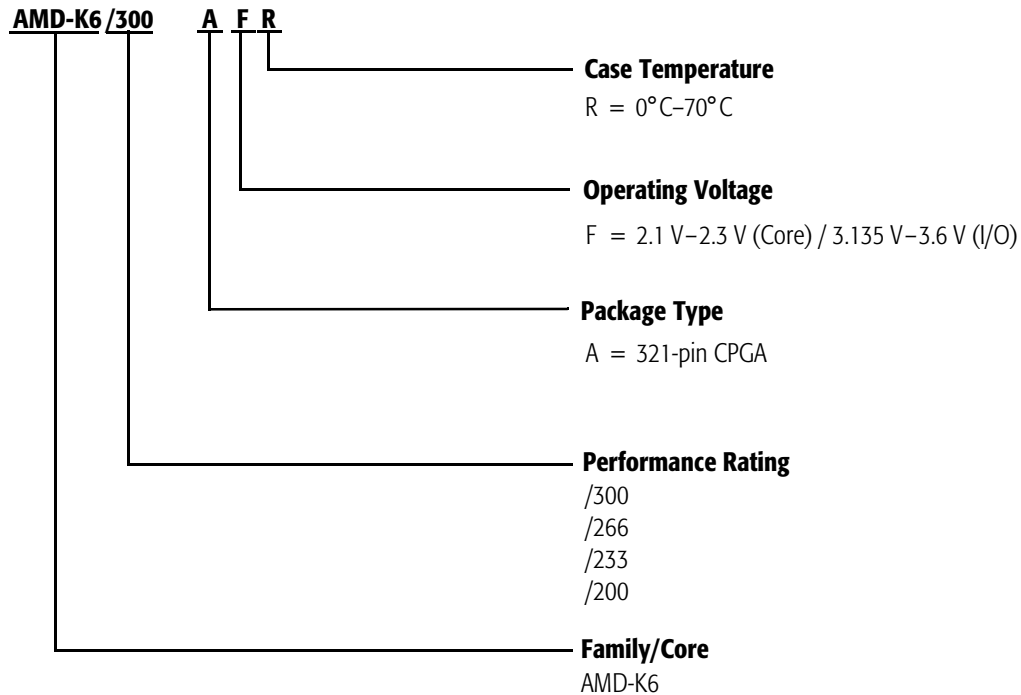

Table 72. Valid Ordering Part Number Combinations

OPN	Package Type	Operating Voltage	Case Temperature
AMD-K6/300AFR	321-pin CPGA	2.1V–2.3V (Core) 3.135V–3.6V (I/O)	0°C–70°C
AMD-K6/266AFR	321-pin CPGA	2.1V–2.3V (Core) 3.135V–3.6V (I/O)	0°C–70°C
AMD-K6/233AFR	321-pin CPGA	2.1V–2.3V (Core) 3.135V–3.6V (I/O)	0°C–70°C
AMD-K6/200AFR	321-pin CPGA	2.1V–2.3V (Core) 3.135V–3.6V (I/O)	0°C–70°C
Notes: <i>This table lists configurations planned to be supported in volume for this device. Consult the local AMD sales office to confirm availability of specific valid combinations and to check on newly-released combinations.</i>			

Index

Numerics

- 0.25-micron process technology 1, 3, 275
- 0.35-micron process technology 1, 3, 275
- 321-Pin Staggered CPGA Package Specification 271
- 60-MHz Bus
 - clock switching characteristics 242
 - input setup and hold timings 250
 - output delay timings 248
- 66-MHz Bus
 - clock switching characteristics 242
 - input setup and hold timings 246
 - output delay timings 244

A

- A[20:3] 237–238
- A[31:3] 80
- A20M# 79, 194
- A20M# Masking of Cache Accesses 187
- Absolute Ratings 233, 305
- Acknowledge, Interrupt 156
- Address
 - Bus 80
 - Hold 82
 - Parity 83
 - Parity Check 84
 - Stack, Return 20
- Address Bus 81–85, 94, 121, 142, 146, 148, 183
- ADS# 81, 237–238
- ADSC# 81
- AHOLD 82, 224
 - initiated inquire hit to modified line 146
 - initiated inquire hit to shared or exclusive line 144
 - initiated inquire miss 142
 - Restriction 148
- Airflow Consideration, Layout and 262
- Airflow Management 264
- Allocate, Write 177
- AMD-K6 MMX Enhanced Processor 5, 277
 - block diagram 10
 - instructions supported 49, 283
 - microarchitecture overview 7
 - Model 6 1, 3, 275
 - Model 7 1, 3, 275
- AP 83
- APCHK# 84
- Application Note, I/O Model 239
- Architecture, Internal 7, 279

B

- Backoff 87
- Base Address, SMM 199
- BE[7:0]# 85
- BF[2:0] 86, 167, 227
- BIST 203
- Bits, Predecode 12, 172

- Block Diagram, AMD-K6 Processor 10
- BOFF# 87, 150
 - Locked Operation with 154
- Boundary Scan
 - Register (BSR) 207
 - Test Access Port (TAP) 205, 299
- BR 211
- Branch
 - execution unit 20
 - history table 19
 - logic 9
 - prediction 5–6, 9, 20, 277–278
 - prediction logic 18–19
 - target cache 19
- BRDY# 88
- BRDYC# 89, 167, 237
- BREQ 90
- BSR 207
- Buffer Characteristics, I/O 237, 309
- Buffer Model, I/O 238
- Built-In Self-Test 203
- Burst Reads 130
- Burst Reads, Pipelined 130
- Burst Ready 88
- Burst Ready Copy 89, 167
- Burst Writeback 132
- Bus
 - address 82–85, 94, 121, 142, 146, 148, 183
 - arbitration cycles, inquire and 136
 - backoff 150
 - cycles 121, 289
 - cycles, special 158
 - data 82, 85, 88, 92–93, 108, 111
 - 124–126, 142, 148, 152
 - enables 85
 - frequency 86
 - hold request 99
 - lock 104
 - request 90
 - state machine diagram 123
- Bus States
 - address 124
 - data 124
 - data-NA# requested 124
 - idle 124
 - pipeline address 124
 - pipeline data 125
 - transition 125
- BYPASS Instruction 212
- Bypass Register 211

C

- Cache 11
 - branch target 19
 - coherency 183
 - disabling 175
 - enable 103
 - flush 97

inhibit, L1	215
MESI states in the data	172
operation	173
organization	171, 293
snooping	186
states	182
writeback	10–11
CACHE#	90, 175
Cacheable Access	90
Cacheable Page, Write to a	178
Cache-Line	
fills	176
replacement	177, 184
Cache-Related Signals	175
Capture-DR state	214
Capture-IR state	214
Case Temperature	262
Centralized Scheduler	16
Characteristics	
I/O buffer	237, 309
I/O Buffer AC and DC	239
CLK	91
Clock	91
Clock Control	223, 301
Clock States	
halt	224
stop clock	161, 226–227
stop grant	161, 225
stop grant inquire	226
Coherency States, Writethrough vs. Writeback	187
Coherency, Cache	183
INVD	184
WBINVD	184
Compatibility, Floating-Point and MMX instructions	191
Configuration and Initialization, Power-on	167, 291
Connection Requirements, Pin	231
Connections, Power	229, 303
Control Register	32
Control Unit, Scheduler/Instruction	9
Counter, Time Stamp	38
Cycle, Hold and Hold Acknowledge	136
Cycle, Shutdown	160
Cycles	
bus	121, 289
inquire	79–84, 94, 98–99, 112, 116, 132, 136, 138
	140, 142, 144–146, 148, 150, 154
	183–187, 215, 223–226
inquire and bus arbitration	136
interrupt acknowledge	80, 83, 85, 91, 106, 115
locked	152
pipelined	12, 81
pipelined write	92
special bus	158
writeback	79, 81–82, 95, 98, 116, 132
	140, 144, 146, 148, 150, 154
	174–175, 216, 226

D

D/C#	91
D[63:0]	92

Data Bus	82, 85, 88, 92–93, 108, 111
	124–126, 142, 148, 152
Data Cache, MESI States in the	172
Data Parity	93
Data Types	
floating-point register	28
integer	23
Data/Code	91
DC Characteristics	234, 306
Debug	216
Debug Exceptions	221
Debug Registers	34, 216
DR3–DR0	219
DR5–DR4	219
DR6	220
DR7	220
Decode, Instruction	14
Decoders	8
Decoupling	
Recommendations	230
Descriptions, Signal	79, 287
Design, Thermal	259, 313
Designations, Pin	269, 317
Device Identification Register	210, 300
Diagram, Pin Description	267, 315
Diagrams, Timing	121
DIR	210, 300
Disabling, Cache	175
Dissipation, Power	235, 307
DP[7:0]	93
DR3–DR0	219
DR5–DR4	219
DR6	220
DR7	220
Drive Strength, Selectable	237

E

EADS#	94
EFER	282
EFLAGS Register	31
Electrical Data	233, 305
Environment, Software	21, 281
EWBE#	95, 224
Exception	83–84, 93, 96, 108, 160, 191, 202, 220–222
flags	26–27
floating-point	96, 100, 189–191
machine check	37
Exception Handler	216
Exceptions	
and interrupts	48
debug	221
floating-point	189
handling floating-point	189
interrupts, and debug in SMM	202
MMX	191
Execution Unit, Branch	20
Execution Unit, Multimedia	191
Execution Units	17
floating-point	189, 295
External Address Strobe	94
External Write Buffer Empty	95
EXTEST instruction	211

F

FERR#	96, 191
Fetch, Instruction	13
Float Conditions	118, 288
Floating-Point	
and MMX instruction compatibility	191
and multimedia execution units	189, 295
error	96
execution unit	189, 295
registers	25
Floating-Point	
handling exceptions	189
register data types	28
FLUSH#	97, 167, 184, 204, 224
Frequency	227, 242, 253
operating	86, 91, 167
Frequency Multiplier	91

G

Gate Descriptor	45, 48
General-Purpose Registers	21, 281
Grounding, Power and	229, 303

H

Halt State	224
Handling Floating-Point Exceptions	189
Heat Dissipation Path	261
HIGHZ instruction	212
History Table, Branch	19
Hit to modified line	98
Hit to Modified Line, AHOLD-Initiated Inquire	146
Hit to Modified Line, HOLD-Initiated Inquire	140
Hit to Shared or Exclusive Line, AHOLD-Initiated Inquire	144
Hit to Shared or Exclusive Line, HOLD-Initiated Inquire	138
HIT#	98
HITM#	98, 237–238
HLDA	99
HOLD	99
Hold Acknowledge	99, 136–138
Hold and Hold Acknowledge Cycle	136
Hold Timing	241, 255
HOLD-Initiated Inquire Hit to Modified Line	140
HOLD-Initiated Inquire Hit to Shared or Exclusive Line	138

I

I/O	
buffer characteristics	237, 309
buffer model	238
misaligned read and write	135
model application note	239
read and write	134
trap dword	200
trap restart slot	201
I/O Buffer AC and DC Characteristics	239
IBIS	238
IDCODE instruction	212

IEEE 1149.1	5, 205, 277, 300
IEEE 754	5, 25, 189, 277
IEEE 854	5, 25, 189, 277
IGNNE#	100, 191
Ignore Numeric Exception	100
INIT	101, 224
INIT, State of Processor After	170
Initialization	101
Initialization, Power-on Configuration and	167, 291
INIT-Initiated Transition from Protected Mode to Real Mode	164
Input Setup and Hold Timings for 60-MHz Bus Operation	250
Input Setup and Hold Timings for 66-MHz Bus Operation	246
Inquire	139, 141, 143, 223
cycles	79–84, 94, 98–99, 112, 116
	132, 136, 138, 140, 142, 144–146, 148
	150, 154, 183–187, 215, 223–226
Inquire and Bus Arbitration Cycles	136
Inquire Cycle Hit	98
Inquire Cycle Hit To Modified Line	98
Inquire Cycles	183
Inquire Miss, AHOLD-Initiated	142
Instruction Decode	14
Instruction Fetch	13
Instruction Pointer	25
Instruction Prefetch	11
Instructions Supported by the AMD-K6 Processor	49, 283
Instructions, TAP	211
Integer Data Types	23
Internal Architecture	7, 279
Internal Snooping	183
Interrupt	102, 111, 156, 160–161, 164
	170, 189–191, 194, 202, 221, 226
acknowledge cycles	80, 83, 85, 91, 106, 115
descriptor table register	39–40
flag	102, 111
flags	31
redirection bitmap	41
request	102
service routine	102, 106, 190, 193
system management	193
Interrupt Acknowledge	80, 88, 91, 102
	104, 108, 152, 156
Interrupt Gate	47
Interrupt, Type of	48
Interrupts	
01h	222
03h	222
10h	189
exceptions and	48
INTR	102
IRQ13	190
NMI	106
INTR	102, 224
INV	102
Invalidation Request	102
INVD	184

K

KEN#	103
------	-----

L

L1 Cache Inhibit	215
Limit, Write Allocate	178
Line Fills, Cache-	176
LOCK#	104
Locked Cycles	152
Locked Operation with BOFF# Intervention	154
Locked Operation, Basic	152
Logic	
branch	9
branch-prediction	18–19
external support of floating-point exceptions	189
symbol diagram	77, 285

M

MIO#	105
Machine Check Exception	37
Maskable Interrupt	102
MCAR	37, 170
MCTR	37–38, 170
Memory or I/O	105
Memory Read and Write, Misaligned Single-Transfer	128
Memory Read and Write, Single-Transfer	126
Memory Reads and Writes	126
MESI	5, 11, 136, 140, 172, 182, 185, 187, 277
bit	12, 172–173
states in the data cache	172
Microarchitecture Overview, AMD-K6 Processor	7
Microarchitecture, Enhanced RISC86	8
Misaligned I/O Read and Write	135
Misaligned Single-Transfer Memory Read and Write	128
MMX	
exceptions	191
instruction compatibility, floating-point and	191
registers	29
Mode, Tri-State Test	204, 299
Model 6	1, 3, 275
Model 7	1, 3, 275
Model-specific registers	37
MSR	37, 281
Multimedia Execution Unit	191

N

NA#	106
Next Address	106
NMI	106, 224
No-connect Pins	110, 231
Non-Maskable Interrupt	106
Non-Pipelined	127, 176

O

Operating Ranges	233, 305
Operation, Cache	173
OPN	273, 321
Ordering Part Number	273, 321
Organization, Cache	171, 293
Output Delay Timings for 60-MHz Bus Operation	248
Output Delay Timings for 66-MHz Bus Operation	244
Output Signals	168, 291

P

Package Specifications	271, 319
Package Thermal Specifications	259, 313
Page Cache Disable	107
Page Directory Entry (PDE)	43–44, 174
Page Table Entry (PTE)	43, 45, 174
Page Writethrough	109
Paging	42
Parity	77, 83, 85, 93, 108, 126, 285
bit	83, 93, 108
check	83–84, 93
error	84, 108, 142, 206
flags	31
Parity Check	108
Part number	273, 321
PCD	107, 174, 180
PCHK#	108
Pin Connection Requirements	231
Pin Description Diagram	267, 315
Pin Designations	269, 317
Pipeline	19, 124–125, 130
Pipeline Control	18
Pipeline, Six-stage	8–9
Pipelined	11, 106, 125, 130–131, 148, 171, 182
Pipelined Burst Reads	130
Pipelined Cycles	12, 81, 92
Pipelined Design	17
Pointer, Instruction	25
Power and Grounding	229, 303
Power Connections	229, 303
Power Dissipation	235, 307
Power-on Configuration and Initialization	167, 291
Predecode Bits	11–12, 172
Prefetching	12, 181
PWT	109

R

Ranges, Operating	233, 305
Ratings, Absolute	233, 305
Read and Write, Basic I/O	134
Read and Write, Misaligned I/O	135
Reads, Burst Reads and Pipelined Burst	130
Register	
boundary scan	207
bypass (BR)	211
control	32
data Types, floating-point	28
debug	34, 216
floating-point	25
general-purpose	21, 281
SYSCALL/SYSRET Target Address (STAR)	282
Registers	9, 21, 168, 191, 281, 291
descriptors and gates	45
device identification (DIR)	210, 300
DR3–DR0	219
DR5–DR4	219
DR6	220
DR7	220
EFLAGS	31
extended feature enable register (EFER)	282

IR	206
MCAR	37
memory management	39, 283
MMX	29
segment	24
STAR	282
TAP	206, 300
TR12	38
WHCR	39, 283
Regulator, Voltage	262
Replacement, Cache-Line	177, 184
Requirements, Pin Connection	231
Reserved	110
RESET	110, 168, 224
and Test Signal Timing	252
signals sampled during	167
state of processor after	168, 291
Return Address Stack	20
Revision Identifier, SMM	198
RISC86 Microarchitecture	8
RSM Instruction	199, 202
RSVD	110

S

SAMPLE/PRELOAD instruction	212
Scheduler, Centralized	16
Scheduler/Instruction Control Unit	9
SCYC	111
Sector, Write to a	178
Segment Descriptor	24, 45–47
Segment Registers	24
Segment Usage	24
Segment, Task State	41
Selectable Drive Strength	237
Shift-DR state	214
Shift-IR state	214
Shutdown Cycle	160
Signal Descriptions	79, 287
Signal Switching Characteristics	241, 311
Signal Timing, RESET and Test	252
Signals	
A[20:3]	237–238
A[31:3]	80
A20M#	79, 194
ADS#	81, 237–238
ADSC#	81
AHOLD	82, 224
AP	83
APCHK#	84
BE[7:0]#	85
BF[2:0]	86, 227
BOFF#	87, 150
BRDY#	88
BRDYC#	89, 237
BREQ	90
CACHE#	90, 175
CLK	91
D/C#	91
D[63:0]	92
DP[7:0]	93
EADS#	94
EWBE#	95, 224
FERR#	96, 191

FLUSH#	97, 167, 184, 204, 224
HIT#	98
HITM#	98, 237–238
HLDA	99
HOLD	99
IGNNE#	100, 191
INIT	101, 224
INTR	102, 224
INV	102
KEN#	103
LOCK#	104
M/IO#	105
NA#	106
NMI	106, 224
PCD	107
PCHK#	108
PWT	109
RESET	110, 224
RSVD	110
SCYC	111
SMI#	111, 193, 224
SMIACT#	112, 193
STPCLK#	113, 225
TCK	113
TDI	114
TDO	114
TMS	114
TRST#	115
VCC2DET	115, 287
VCC2H/L#	287
WR#	115, 237–238
WB/WT#	116
Signals Sampled During RESET	167
Signals, Output	168, 291
Signals, TAP	205
Single-Transfer Memory Read and Write	126
SMI#	111, 193, 224
SMIACT#	112, 193
SMM	193, 297
base address	199
default register values	193
halt restart slot	199
I/O trap DWORD	200
I/O trap restart slot	201
operating mode	193
revision identifier	198
state-save area	196
Snoop	112, 116, 132, 183, 185–186
Snooping, Cache	186
Snooping, Internal	183
Software Environment	21, 281
Special Bus Cycle	88, 113, 158–161, 200, 225
Special Bus Cycles	158
Special Cycle	95, 97, 113, 119, 132, 158
	160–161, 176, 224–225
Specifications, Package	271, 319
Specifications, Package Thermal	259, 313
Split Cycle	111
Stack, Return Address	20
State Machine Diagram, Bus	123
State of Processor After INIT	170, 291
State of Processor After RESET	168, 291
States, Cache	182
State-Save Area, SMM	196

Stop Clock	113
Stop Clock State	161, 226–227
Stop Grant Inquire State	223–226
Stop Grant State	161, 225–226
STPCLK#	113, 225
Switching Characteristics	241
60-MHz bus operation	242
66-MHz bus operation	242
input setup and hold timings for 60-MHz bus	250
input setup and hold timings for 66-MHz bus	246
output delay timings for 60-MHz bus	248
output delay timings for 66-MHz bus	244
Signal	241, 311
valid delay, float, setup, and hold timings	243
SYSCALL	282–283
SYSCALL/SYSRET Target Address Register (STAR)	282–283
SYSRET	283
System Design, Airflow Management in a	264
System Management Interrupt	111
System Management Interrupt Active	112
System Management Mode (SMM)	193, 297

T

Table, Branch History	19
TAP	205, 299
TAP Controller States	
Capture-DR	214
Capture-IR	214
Shift-DR	214
Shift-IR	214
State Machine	212
test-logic-reset	214
Update-DR	214
Update-IR	214
TAP Instructions	211
BYPASS	212
EXTEST	211
HIGHZ	212
IDCODE	212
SAMPLE/PRELOAD	212
TAP Registers	206, 300
Instruction Register (IR)	206
TAP Signals	205
Target Cache, Branch	19
Task State Segment	41
TCK	113
TDI	114
TDO	114
Temperature	233, 259–260, 262, 305, 313
case	262
Test Access Port, Boundary-Scan	205, 299
Test and Debug	203, 299
Test Clock	113
Test Data Input	114
Test Data Output	114
Test Mode Select	114
Test Mode, Tri-State	204, 299
Test Register 12 (TR12)	38
Test Reset	115

Test-Logic-Reset state	214
Thermal	235, 260–264, 307
design	259, 313
heat dissipation path	261
layout and airflow consideration	262
measuring case temperature	262
package specifications	259, 313
Time Stamp Counter	38
Timing Diagram	257
Timing Diagrams	121
TMS	114
TR12	37–38, 170, 174–175, 180, 215
Transition from Protected Mode to Real Mode, INIT-Initiated	164
Translation Lookaside Buffer (TLB)	171
Trap Dword, I/O	200
Tri-State Test Mode	204, 299
TRST#	115
TSC	37–38, 170, 224–225
TSS	41, 47–48, 197, 220

V

VCC2DET	115, 287
VCC2H/L#	287
Voltage	115, 122, 229, 233–234, 238, 241
regulator	287, 303, 305–306
regulator	262–263
Voltage Ranges	238

W

W/R#	115, 237–238
WAE15M	178
WAELIM	178
WB/WT#	116
WBINVD	184
WCDE	39, 178, 181
WHCR	37, 39, 170, 179, 181, 283
Write Allocate	173, 177–182
enable	39, 178
enable limit	39, 178
limit	178
logic mechanisms and conditions	180
Write Handling Control Register (WHCR)	39, 283
Write to a Cacheable Page	178
Write to a Sector	178
Write/Read	115
Writeback	90, 92–93, 103, 109, 112, 116, 119
burst	132–133, 158, 171, 176, 182, 185, 187, 228
cycles	132
cycles	79, 81–82, 95, 98, 116, 132
cycles	140, 144, 146, 148, 150, 154
cycles	174–175, 216, 226
Writeback Cache	10–11
Writeback or Writethrough	116
Writethrough vs. Writeback Coherency States	187