



## **Cisco Redundant Power System Hardware Installation Guide**

### **Corporate Headquarters**

Cisco Systems, Inc.  
170 West Tasman Drive  
San Jose, CA 95134-1706  
USA  
<http://www.cisco.com>  
Tel: 408 526-4000  
800 553-NETS (6387)  
Fax: 408 526-4100

Text Part Number: OL-3654-01



THE SPECIFICATIONS AND INFORMATION REGARDING THE PRODUCTS IN THIS MANUAL ARE SUBJECT TO CHANGE WITHOUT NOTICE. ALL STATEMENTS, INFORMATION, AND RECOMMENDATIONS IN THIS MANUAL ARE BELIEVED TO BE ACCURATE BUT ARE PRESENTED WITHOUT WARRANTY OF ANY KIND, EXPRESS OR IMPLIED. USERS MUST TAKE FULL RESPONSIBILITY FOR THEIR APPLICATION OF ANY PRODUCTS.

THE SOFTWARE LICENSE AND LIMITED WARRANTY FOR THE ACCOMPANYING PRODUCT ARE SET FORTH IN THE INFORMATION PACKET THAT SHIPPED WITH THE PRODUCT AND ARE INCORPORATED HEREIN BY THIS REFERENCE. IF YOU ARE UNABLE TO LOCATE THE SOFTWARE LICENSE OR LIMITED WARRANTY, CONTACT YOUR CISCO REPRESENTATIVE FOR A COPY.

The following information is for FCC compliance of Class A devices: This equipment has been tested and found to comply with the limits for a Class A digital device, pursuant to part 15 of the FCC rules. These limits are designed to provide reasonable protection against harmful interference when the equipment is operated in a commercial environment. This equipment generates, uses, and can radiate radio-frequency energy and, if not installed and used in accordance with the instruction manual, may cause harmful interference to radio communications. Operation of this equipment in a residential area is likely to cause harmful interference, in which case users will be required to correct the interference at their own expense.

The following information is for FCC compliance of Class B devices: The equipment described in this manual generates and may radiate radio-frequency energy. If it is not installed in accordance with Cisco's installation instructions, it may cause interference with radio and television reception. This equipment has been tested and found to comply with the limits for a Class B digital device in accordance with the specifications in part 15 of the FCC rules. These specifications are designed to provide reasonable protection against such interference in a residential installation. However, there is no guarantee that interference will not occur in a particular installation.

Modifying the equipment without Cisco's written authorization may result in the equipment no longer complying with FCC requirements for Class A or Class B digital devices. In that event, your right to use the equipment may be limited by FCC regulations, and you may be required to correct any interference to radio or television communications at your own expense.

You can determine whether your equipment is causing interference by turning it off. If the interference stops, it was probably caused by the Cisco equipment or one of its peripheral devices. If the equipment causes interference to radio or television reception, try to correct the interference by using one or more of the following measures:

- Turn the television or radio antenna until the interference stops.
- Move the equipment to one side or the other of the television or radio.
- Move the equipment farther away from the television or radio.
- Plug the equipment into an outlet that is on a different circuit from the television or radio. (That is, make certain the equipment and the television or radio are on circuits controlled by different circuit breakers or fuses.)

Modifications to this product not authorized by Cisco Systems, Inc. could void the FCC approval and negate your authority to operate the product.

The Cisco implementation of TCP header compression is an adaptation of a program developed by the University of California, Berkeley (UCB) as part of UCB's public domain version of the UNIX operating system. All rights reserved. Copyright © 1981, Regents of the University of California.

NOTWITHSTANDING ANY OTHER WARRANTY HEREIN, ALL DOCUMENT FILES AND SOFTWARE OF THESE SUPPLIERS ARE PROVIDED "AS IS" WITH ALL FAULTS. CISCO AND THE ABOVE-NAMED SUPPLIERS DISCLAIM ALL WARRANTIES, EXPRESSED OR IMPLIED, INCLUDING, WITHOUT LIMITATION, THOSE OF MERCHANTABILITY, FITNESS FOR A PARTICULAR PURPOSE AND NONINFRINGEMENT OR ARISING FROM A COURSE OF DEALING, USAGE, OR TRADE PRACTICE.

IN NO EVENT SHALL CISCO OR ITS SUPPLIERS BE LIABLE FOR ANY INDIRECT, SPECIAL, CONSEQUENTIAL, OR INCIDENTAL DAMAGES, INCLUDING, WITHOUT LIMITATION, LOST PROFITS OR LOSS OR DAMAGE TO DATA ARISING OUT OF THE USE OR INABILITY TO USE THIS MANUAL, EVEN IF CISCO OR ITS SUPPLIERS HAVE BEEN ADVISED OF THE POSSIBILITY OF SUCH DAMAGES

CCVP, the Cisco logo, and Welcome to the Human Network are trademarks of Cisco Systems, Inc.; Changing the Way We Work, Live, Play, and Learn is a service mark of Cisco Systems, Inc.; and Access Registrar, Aironet, Catalyst, CCDA, CCDP, CCIE, CCIP, CCNA, CCNP, CCSP, Cisco, the Cisco Certified Internetwork Expert logo, Cisco IOS, Cisco Press, Cisco Systems, Cisco Systems Capital, the Cisco Systems logo, Cisco Unity, Enterprise/Solver, EtherChannel, EtherFast, EtherSwitch, Fast Step, Follow Me Browsing, FormShare, GigaDrive, HomeLink, Internet Quotient, IOS, iPhone, IP/TV, iQ Expertise, the iQ logo, iQ Net Readiness Scorecard, iQuick Study, LightStream, Linksys, MeetingPlace, MGX, Networkers, Networking Academy, Network Registrar, PIX, ProConnect, ScriptShare, SMARTnet, StackWise, The Fastest Way to Increase Your Internet Quotient, and TransPath are registered trademarks of Cisco Systems, Inc. and/or its affiliates in the United States and certain other countries.

All other trademarks mentioned in this document or Website are the property of their respective owners. The use of the word partner does not imply a partnership relationship between Cisco and any other company. (0711R)





## **Preface** ix

Audience x

Organization x

Related Publications x

Notes, Cautions, and Warnings xi

Obtaining Documentation xviii

World Wide Web xviii

Documentation CD-ROM xviii

Ordering Documentation xviii

Documentation Feedback xix

Obtaining Technical Assistance xix

Cisco.com xix

Technical Assistance Center xx

Cisco TAC Web Site xx

Cisco TAC Escalation Center xxi

---

## **CHAPTER 1**

### **Overview** 1-1

Features 1-1

Supported Devices and Configurations 1-2

Quasi-Redundant Configuration 1-4

Fully Redundant Configuration 1-5

Redundant with Reboot 1-6

Quasi- and Fully Redundant Mixed Configuration 1-7

Front and Rear Panel Descriptions 1-8

LEDs 1-9

Safety Recommendations 1-11

Safety Warnings 1-12

Safety with Electricity 1-12

---

**CHAPTER 2**

**Installing the Cisco RPS 2-1**

Setting the Cisco RPS on a Desktop 2-3

Rack-Mounting the Cisco RPS 2-3

    Planning Your Rack-Mount Installation 2-4

    Tools and Equipment Required 2-5

    Identifying Rack-Mount Brackets 2-5

    Attaching Brackets 2-6

    Mounting the Chassis in a Rack 2-8

---

**CHAPTER 3**

**Connection Requirements 3-1**

Tools and Equipment Required 3-2

Cabling Options 3-2

Ordering Cables 3-3

Upgrade Kit with Power Adapter Plate for Routers and Concentrators 3-6

---

**CHAPTER 4**

**Connecting the Cisco RPS 4-1**

Power Considerations 4-1

Connecting Hubs 4-2

Connecting Switches 4-6

Connecting Routers and the Cisco MC3810 Concentrator 4-13

---

**CHAPTER 5**

**Troubleshooting the Cisco RPS 5-1**

Reading the LEDs 5-1

Displaying Status	5-5
Error Messages on Cisco 2600 Series and Cisco 3620, Cisco 3640, and Cisco 3725 Routers	5-6
DC Failure	5-6
AC Failure	5-7
Fan Failure	5-9
Temperature Error	5-10
Multiple Errors	5-12
Replacing an External Device	5-13
Getting Technical Support	5-14

---

**APPENDIX A****Technical Specifications** A-1

---

**INDEX**







## Preface

---

The *Cisco Redundant Power System Hardware Installation Guide* documents operation and features of the Cisco 600W Redundant Power System (RPS). It provides installation instructions and troubleshooting information for the RPS, which can be used to support the following current product lines:

- FastHub 400 series hubs and Cisco 1516M hubs (also known as the HP 10BASE-T Hub-16M)
- Catalyst 1900 series switches, Catalyst 2820 series switches, Catalyst 2900 series XL switches, and Catalyst 3500 series XL switches
- Cisco 2500 series routers and access servers, Cisco 3620, 3640, and 3725 routers, and Cisco 2600 series and Cisco 4000 series routers
- Cisco MC3810 series multiservice concentrators

Cisco documentation and additional literature are contained in a CD-ROM package, which ships with your product. The Documentation CD-ROM, a member of the Cisco Connection Family, is updated monthly. Therefore, it might be more current than printed documentation. To order additional copies of the Documentation CD-ROM, contact your local sales representative or call customer service. The CD-ROM package is available as a single package or as an annual subscription. You can also access Cisco documentation on the World Wide Web at <http://www.cisco.com>, <http://www-china.cisco.com>, or <http://www-europe.cisco.com>.

If you are reading Cisco product documentation on the World Wide Web, you can submit comments electronically. Click **Feedback** in the toolbar and select **Documentation**. After you complete the form, click **Submit** to send it to Cisco. We appreciate your comments.

# Audience

This publication is designed for people who have some experience installing networking equipment such as routers, hubs, servers, and switches. We assume that the person installing and troubleshooting the Cisco RPS is familiar with electronic circuitry and wiring practices and has experience as an electronic or electromechanical technician.

# Organization

[Table 1](#) describes the document organization.

**Table 1** Document Organization

Chapter	Title	Description
Chapter 1	<a href="#">Overview</a>	Gives an overview of the Cisco RPS, features, supported devices, configurations, physical description including LEDs, and safety recommendations.
Chapter 2	<a href="#">Installing the Cisco RPS</a>	Provides instructions for setting the Cisco RPS on a desktop or for rack-mounting the Cisco RPS.
Chapter 3	<a href="#">Connection Requirements</a>	Explains the cabling options for connecting the Cisco RPS to external devices and how to order cabling and upgrade kits appropriate for each device.
Chapter 4	<a href="#">Connecting the Cisco RPS</a>	Provides procedures for connecting the Cisco RPS to the supported external devices (see <a href="#">Table 1-1 on page 3</a> ) and steps for replacing a failed external device receiving power from the Cisco RPS.
Chapter 5	<a href="#">Troubleshooting the Cisco RPS</a>	Describes how to identify and resolve some of the problems that might arise with the Cisco RPS.
Appendix A	<a href="#">Technical Specifications</a>	Lists the technical specifications for the Cisco RPS.

## Related Publications

For more related information, refer to the installation and configuration guides for the specific switch or router. For routers and concentrators that require a power adapter plate, also refer to the instructions that ship with the plate.

## Notes, Cautions, and Warnings

Notes, cautions, and warnings use the following conventions and symbols.

**Note**

---

Means *reader take note*. Notes contain helpful suggestions or references to additional information and material.

---

**Caution**

---

Means *reader be careful*. In this situation, you might do something that could result in equipment damage or loss of data.

---

**Warning**

---

**IMPORTANT SAFETY INSTRUCTIONS**

**This warning symbol means danger. You are in a situation that could cause bodily injury. Before you work on any equipment, be aware of the hazards involved with electrical circuitry and be familiar with standard practices for preventing accidents. To see translations of the warnings that appear in this publication, refer to the translated safety warnings that accompanied this device.**

**Note: SAVE THESE INSTRUCTIONS**

**Note: This documentation is to be used in conjunction with the specific product installation guide that shipped with the product. Please refer to the Installation Guide, Configuration Guide, or other enclosed additional documentation for further details.**

**Waarschuwing BELANGRIJKE VEILIGHEIDSINSTRUCTIES**

Dit waarschuwingssymbool betekent gevaar. U verkeert in een situatie die lichamelijk letsel kan veroorzaken. Voordat u aan enige apparatuur gaat werken, dient u zich bewust te zijn van de bij elektrische schakelingen betrokken risico's en dient u op de hoogte te zijn van de standaard praktijken om ongelukken te voorkomen. Voor een vertaling van de waarschuwingen die in deze publicatie verschijnen, dient u de vertaalde veiligheidswaarschuwingen te raadplegen die bij dit apparaat worden geleverd.

**Opmerking BEWAAR DEZE INSTRUCTIES.**

**Opmerking** Deze documentatie dient gebruikt te worden in combinatie met de installatiehandleiding voor het specifieke product die bij het product wordt geleverd. Raadpleeg de installatiehandleiding, configuratiehandleiding of andere verdere ingesloten documentatie voor meer informatie.

**Varoitus TÄRKEITÄ TURVALLISUUTEEN LIITTYVIÄ OHJEITA**

Tämä varoitusmerkki merkitsee vaaraa. Olet tilanteessa, joka voi johtaa ruumiinvammaan. Ennen kuin työskentelet minkään laitteiston parissa, ota selvää sähkökytkentöihin liittyvistä vaaroista ja tavanomaisista onnettomuuksien ehkäisykeinoista. Tässä asiakirjassa esitettyjen varoitusten käännökset löydät laitteen mukana toimitetuista ohjeista.

**Huomautus SÄILYTÄ NÄMÄ OHJEET**

**Huomautus** Tämä asiakirja on tarkoitettu käytettäväksi yhdessä tuotteen mukana tulleen asennusoppaan kanssa. Katso lisätietoja asennusoppaasta, kokoonpano-oppaasta ja muista mukana toimitetuista asiakirjoista.

**Attention      IMPORTANTES INFORMATIONS DE SÉCURITÉ**

**Ce symbole d'avertissement indique un danger. Vous vous trouvez dans une situation pouvant causer des blessures ou des dommages corporels. Avant de travailler sur un équipement, soyez conscient des dangers posés par les circuits électriques et familiarisez-vous avec les procédures couramment utilisées pour éviter les accidents. Pour prendre connaissance des traductions d'avertissements figurant dans cette publication, consultez les consignes de sécurité traduites qui accompagnent cet appareil.**

**Remarque      CONSERVEZ CES INFORMATIONS**

**Remarque      Cette documentation doit être utilisée avec le guide spécifique d'installation du produit qui accompagne ce dernier. Veuillez vous reporter au Guide d'installation, au Guide de configuration, ou à toute autre documentation jointe pour de plus amples renseignements.**

**Warnung      WICHTIGE SICHERHEITSANWEISUNGEN**

**Dieses Warnsymbol bedeutet Gefahr. Sie befinden sich in einer Situation, die zu einer Körperverletzung führen könnte. Bevor Sie mit der Arbeit an irgendeinem Gerät beginnen, seien Sie sich der mit elektrischen Stromkreisen verbundenen Gefahren und der Standardpraktiken zur Vermeidung von Unfällen bewusst. Übersetzungen der in dieser Veröffentlichung enthaltenen Warnhinweise sind im Lieferumfang des Geräts enthalten.**

**Hinweis      BEWAHREN SIE DIESE SICHERHEITSANWEISUNGEN AUF**

**Hinweis      Dieses Handbuch ist zum Gebrauch in Verbindung mit dem Installationshandbuch für Ihr Gerät bestimmt, das dem Gerät beiliegt. Entnehmen Sie bitte alle weiteren Informationen dem Handbuch (Installations- oder Konfigurationshandbuch o. Ä.) für Ihr spezifisches Gerät.**

**Figyelem! FONTOS BIZTONSÁGI ELŐÍRÁSOK**

Ez a figyelmeztető jel veszélyre utal. Sérülésveszélyt rejtő helyzetben van. Mielőtt bármely berendezésen munkát végezte, legyen figyelemmel az elektromos áramkörök okozta kockázatokra, és ismerkedjen meg a szokásos balesetvédelmi eljárásokkal. A kiadványban szereplő figyelmeztetések fordítása a készülékhez mellékelt biztonsági figyelmeztetések között található.

**Megjegyzés ŐRIZZE MEG EZEKET AZ UTASÍTÁSOKAT!**

**Megjegyzés** Ezt a dokumentációt a készülékhez mellékelt üzembe helyezési útmutatóval együtt kell használni. További tudnivalók a mellékelt Üzembe helyezési útmutatóban (Installation Guide), Konfigurációs útmutatóban (Configuration Guide) vagy más dokumentumban található.

**Avvertenza IMPORTANTI ISTRUZIONI SULLA SICUREZZA**

Questo simbolo di avvertenza indica un pericolo. La situazione potrebbe causare infortuni alle persone. Prima di intervenire su qualsiasi apparecchiatura, occorre essere al corrente dei pericoli relativi ai circuiti elettrici e conoscere le procedure standard per la prevenzione di incidenti. Per le traduzioni delle avvertenze riportate in questo documento, vedere le avvertenze di sicurezza che accompagnano questo dispositivo.

**Nota CONSERVARE QUESTE ISTRUZIONI**

**Nota** La presente documentazione va usata congiuntamente alla guida di installazione specifica spedita con il prodotto. Per maggiori informazioni, consultare la Guida all'installazione, la Guida alla configurazione o altra documentazione acclusa.

**Advarsel VIKTIGE SIKKERHETSINSTRUKSJONER**

**Dette varselssymbolet betyr fare. Du befinner deg i en situasjon som kan forårsake personskade. Før du utfører arbeid med utstyret, bør du være oppmerksom på farene som er forbundet med elektriske kretssystemer, og du bør være kjent med vanlig praksis for å unngå ulykker. For å se oversettelser av advarslene i denne publikasjonen, se de oversatte sikkerhetsvarslene som følger med denne enheten.**

**Merk TA VARE PÅ DISSE INSTRUKSJONENE**

**Merk Denne dokumentasjonen skal brukes i forbindelse med den spesifikke installasjonsveiledningen som fulgte med produktet. Vennligst se installasjonsveiledningen, konfigureringsveiledningen eller annen vedlagt tilleggsdokumentasjon for detaljer.**

**Aviso INSTRUÇÕES IMPORTANTES DE SEGURANÇA**

**Este símbolo de aviso significa perigo. O utilizador encontra-se numa situação que poderá ser causadora de lesões corporais. Antes de iniciar a utilização de qualquer equipamento, tenha em atenção os perigos envolvidos no manuseamento de circuitos eléctricos e familiarize-se com as práticas habituais de prevenção de acidentes. Para ver traduções dos avisos incluídos nesta publicação, consulte os avisos de segurança traduzidos que acompanham este dispositivo.**

**Nota GUARDE ESTAS INSTRUÇÕES**

**Nota Esta documentação destina-se a ser utilizada em conjunto com o manual de instalação incluído com o produto específico. Consulte o manual de instalação, o manual de configuração ou outra documentação adicional inclusa, para obter mais informações.**

**¡Advertencia! INSTRUCCIONES IMPORTANTES DE SEGURIDAD**

Este símbolo de aviso indica peligro. Existe riesgo para su integridad física. Antes de manipular cualquier equipo, considere los riesgos de la corriente eléctrica y familiarícese con los procedimientos estándar de prevención de accidentes. Vea las traducciones de las advertencias que acompañan a este dispositivo.

**Nota GUARDE ESTAS INSTRUCCIONES**

Nota Esta documentación está pensada para ser utilizada con la guía de instalación del producto que lo acompaña. Si necesita más detalles, consulte la Guía de instalación, la Guía de configuración o cualquier documentación adicional adjunta.

**Varning! VIKTIGA SÄKERHETSANVISNINGAR**

Denna varningssignal signalerar fara. Du befinner dig i en situation som kan leda till personskada. Innan du utför arbete på någon utrustning måste du vara medveten om farorna med elkretsar och känna till vanliga förfaranden för att förebygga olyckor. Se översättningarna av de varningsmeddelanden som finns i denna publikation, och se de översatta säkerhetsvarningarna som medföljer denna anordning.

**OBS! SPARA DESSA ANVISNINGAR**

**OBS!** Denna dokumentation ska användas i samband med den specifika produktinstallationshandbok som medföljde produkten. Se installationshandboken, konfigurationshandboken eller annan bifogad ytterligare dokumentation för närmare detaljer.



**Предупреждение**      **ВАЖНЫЕ СВЕДЕНИЯ ПО БЕЗОПАСНОСТИ**

Этот символ предупреждает о наличии опасности. При неправильных действиях возможно получение травм. Перед началом работы с любым оборудованием необходимо ознакомиться с ситуациями, в которых возможно поражение электротоком, и со стандартными действиями для предотвращения несчастных случаев. Переведенный текст предупреждений содержится в соответствующем документе, поставляемом вместе с устройством.

Примечание      **СОХРАНЯЙТЕ ЭТУ ИНСТРУКЦИЮ**

Примечание      Эта инструкция должна использоваться вместе с руководством по установке конкретного изделия, входящим в комплект поставки. Дополнительные сведения см. в руководстве по установке, руководстве по настройке и другой документации, поставляемой с изделием.

**警告**      有关安全的重要说明

这个警告符号指有危险。您所处的环境可能使身体受伤。操作设备前必须意识到电流的危险性，务必熟悉操作标准，以防发生事故。如果需要了解本说明中出现的警告符号的译文，请参阅本装置所附之安全警告译文。

注意      保存这些说明

注意      本文件应与本产品附带的具体安装说明一并阅读。如欲了解详情，请参阅《安装说明》、《配置说明》或所附的其他文件。

**警告**      安全上の重要な注意事項

「危険」の意味です。人身事故を予防するための注意事項が記述されています。装置の取り扱い作業を行うときは、電気回路の危険性に注意し、一般的な事故防止対策に留意してください。このマニュアルに記載されている警告の各国語版は、装置に付属の「Translated Safety Warnings」を参照してください。

注      これらの注意事項を保管しておいてください。

注      この資料は、製品に付属のインストレーション ガイドと併用してください。詳細は、インストレーション ガイド、コンフィギュレーション ガイド、または添付されているその他のマニュアルを参照してください。

# Obtaining Documentation

These sections explain how to obtain documentation from Cisco Systems.

## World Wide Web

You can access the most current Cisco documentation on the World Wide Web at this URL:

<http://www.cisco.com>

Translated documentation is available at this URL:

[http://www.cisco.com/public/countries\\_languages.shtml](http://www.cisco.com/public/countries_languages.shtml)

## Documentation CD-ROM

Cisco documentation and additional literature are available in a Cisco Documentation CD-ROM package, which is shipped with your product. The Documentation CD-ROM is updated monthly and may be more current than printed documentation. The CD-ROM package is available as a single unit or through an annual subscription.

## Ordering Documentation

You can order Cisco documentation in these ways:

- Registered Cisco.com users (Cisco direct customers) can order Cisco product documentation from the Networking Products MarketPlace:  
[http://www.cisco.com/cgi-bin/order/order\\_root.pl](http://www.cisco.com/cgi-bin/order/order_root.pl)
- Registered Cisco.com users can order the Documentation CD-ROM through the online Subscription Store:  
<http://www.cisco.com/go/subscription>
- Nonregistered Cisco.com users can order documentation through a local account representative by calling Cisco Systems Corporate Headquarters (California, U.S.A.) at 408 526-7208 or, elsewhere in North America, by calling 800 553-NETS (6387).

## Documentation Feedback

You can submit comments electronically on Cisco.com. In the Cisco Documentation home page, click the **Fax** or **Email** option in the “Leave Feedback” section at the bottom of the page.

You can e-mail your comments to bug-doc@cisco.com.

You can submit your comments by mail by using the response card behind the front cover of your document or by writing to the following address:

Cisco Systems  
Attn: Document Resource Connection  
170 West Tasman Drive  
San Jose, CA 95134-9883

We appreciate your comments.

## Obtaining Technical Assistance

Cisco provides Cisco.com as a starting point for all technical assistance. Customers and partners can obtain online documentation, troubleshooting tips, and sample configurations from online tools by using the Cisco Technical Assistance Center (TAC) Web Site. Cisco.com registered users have complete access to the technical support resources on the Cisco TAC Web Site.

## Cisco.com

Cisco.com is the foundation of a suite of interactive, networked services that provides immediate, open access to Cisco information, networking solutions, services, programs, and resources at any time, from anywhere in the world.

Cisco.com is a highly integrated Internet application and a powerful, easy-to-use tool that provides a broad range of features and services to help you with these tasks:

- Streamline business processes and improve productivity
- Resolve technical issues with online support
- Download and test software packages

- Order Cisco learning materials and merchandise
- Register for online skill assessment, training, and certification programs

If you want to obtain customized information and service, you can self-register on Cisco.com. To access Cisco.com, go to this URL:

<http://www.cisco.com>

## Technical Assistance Center

The Cisco Technical Assistance Center (TAC) is available to all customers who need technical assistance with a Cisco product, technology, or solution. Two levels of support are available: the Cisco TAC Web Site and the Cisco TAC Escalation Center.

Cisco TAC inquiries are categorized according to the urgency of the issue:

- Priority level 4 (P4)—You need information or assistance concerning Cisco product capabilities, product installation, or basic product configuration.
- Priority level 3 (P3)—Your network performance is degraded. Network functionality is noticeably impaired, but most business operations continue.
- Priority level 2 (P2)—Your production network is severely degraded, affecting significant aspects of business operations. No workaround is available.
- Priority level 1 (P1)—Your production network is down, and a critical impact to business operations will occur if service is not restored quickly. No workaround is available.

The Cisco TAC resource that you choose is based on the priority of the problem and the conditions of service contracts, when applicable.

## Cisco TAC Web Site

You can use the Cisco TAC Web Site to resolve P3 and P4 issues yourself, saving both cost and time. The site provides around-the-clock access to online tools, knowledge bases, and software. To access the Cisco TAC Web Site, go to this URL:

<http://www.cisco.com/tac>

All customers, partners, and resellers who have a valid Cisco service contract have complete access to the technical support resources on the Cisco TAC Web Site. The Cisco TAC Web Site requires a Cisco.com login ID and password. If you have a valid service contract but do not have a login ID or password, go to this URL to register:

<http://www.cisco.com/register/>

If you are a Cisco.com registered user, and you cannot resolve your technical issues by using the Cisco TAC Web Site, you can open a case online by using the TAC Case Open tool at this URL:

<http://www.cisco.com/tac/caseopen>

If you have Internet access, we recommend that you open P3 and P4 cases through the Cisco TAC Web Site.

## Cisco TAC Escalation Center

The Cisco TAC Escalation Center addresses priority level 1 or priority level 2 issues. These classifications are assigned when severe network degradation significantly impacts business operations. When you contact the TAC Escalation Center with a P1 or P2 problem, a Cisco TAC engineer automatically opens a case.

To obtain a directory of toll-free Cisco TAC telephone numbers for your country, go to this URL:

<http://www.cisco.com/warp/public/687/Directory/DirTAC.shtml>

Before calling, please check with your network operations center to determine the level of Cisco support services to which your company is entitled: for example, SMARTnet, SMARTnet Onsite, or Network Supported Accounts (NSA). When you call the center, please have available your service agreement number and your product serial number.





# Overview

---

The Cisco 600W Redundant Power System (RPS) provides power system redundancy to external devices such as routers, switches, and hubs. The system includes two fully redundant AC input power modules and four DC output power modules for connection to external devices. The Cisco RPS supports quasi-redundant, fully redundant, or redundant-with-reboot configurations, depending upon the external device.

This chapter provides an overview of the Cisco RPS features, including the supported external devices and power configurations, in the following sections:

- [Features, page 1-1](#)
- [Supported Devices and Configurations, page 1-2](#)
- [Front and Rear Panel Descriptions, page 1-8](#)
- [Safety Recommendations, page 1-11](#)

## Features

The following features are standard:

- Two AC input power cords
- Two fully redundant AC input power modules
- Four 150W DC output power modules
- Rack-mountable chassis (19-inch rack-mount brackets included)
- Redundant cooling fans

- LEDs for AC, DC, fans, and temperature status
- Simple Network Management Protocol (SNMP) support of error messages for Cisco 2600 series and Cisco 3620/3640 series routers. (There is no SNMP support for error messages in the Cisco 1516M hub, FastHub 400 series hub, Catalyst 1900 series switches, Catalyst 2820 series switches, Catalyst 2900 and Catalyst 3500 series XL switches, Cisco 2500 and 4000 series routers, and the Cisco MC3810 multiservice concentrator.)

The Cisco RPS ships in either of the following configurations:

- With cables (Cisco RPS number PWR600-AC-RPS-CAB)—Includes four one-to-one (22-pin to 18-pin) cables for connecting to hubs and switches or for quasi-redundant support for Cisco 2600 series routers; Cisco 3620, Cisco 3640, and Cisco 3725 routers; and Cisco 4000 series routers.
- Without cables (Cisco RPS number PWR600-AC-RPS-NCAB)—Cables must be ordered separately:
  - One-to-one (22-pin to 18-pin) cables for connecting to hubs and switches or for quasi-redundant support for Cisco 2600 series routers; Cisco 3620, Cisco 3640, and Cisco 3725 routers; and Cisco 4000 series routers
  - One-to-one (22-pin to 8-pin) cables for quasi-redundant support for Cisco 2500 series routers and access servers and Cisco MC3810 multiservice concentrators
  - Two-to-one Y cables (22-pin to 18-pin or 22-pin to 8-pin) for fully redundant support only for routers or concentrators

**Note**

Refer to [Table 3-1 on page 3-5](#) for cable descriptions and order numbers.

## Supported Devices and Configurations

[Table 1-1](#) lists the supported external devices and power configurations. The power configurations are described in the following subsections.



**Table 1-1 Cisco RPS-Supported External Devices and Power Configurations**

External Device	Quasi-Redundant <sup>1</sup>	Fully Redundant	Redundant with Reboot <sup>2</sup>
FastHub 400 series hubs <sup>3</sup>	Yes	No	Yes
Cisco 1516M hub (HP 10BASE-T Hub-16M)	Yes	No	No
Catalyst 1900 series switches	Yes	No	Yes
Catalyst 2820 series switches	Yes	No	Yes
Catalyst 2900 series XL switches	Yes	No	Yes
Catalyst 3500 series XL switches <sup>4</sup>	Yes	No	Yes
Cisco 2500 series routers and access servers <sup>5</sup>	Yes	Yes	No
Cisco 2600 series routers	Yes	Yes	No
Cisco 3620 and Cisco 3640 routers	Yes	Yes	No
Cisco 3725 routers	Yes	Yes	No
Cisco MC3810 multiservice concentrators	Yes	Yes	No
Cisco 4000 series routers	Yes	Yes	No

1. The Cisco RPS has a demonstrated mean time between failures (MTBF) of greater than 500,000 hours in this mode.
2. The redundant-with-reboot configuration is not recommended because of the reboot and downtime; if you use this configuration, always power up the switch *before* you power up the Cisco RPS to ensure correct operation.
3. The Cisco RPS can also be used with the older FastHub 100, 200, and 300 series hubs.
4. If you are using a Cisco RPS with a revision level lower than Z3 with a Catalyst 3508G or a Catalyst 3548 XL switch, the switch RPS LED and the RPS DC LED might display amber (normally indicating RPS malfunction) even when the Cisco RPS is functioning properly. The LEDs display correctly for Cisco RPS revision level Z3 or later revision. The label on the bottom of the Cisco RPS shows the revision level.
5. For simplicity, Cisco 2500 series access servers, such as the Cisco 2509 or the Cisco 2511, are referred to as Cisco 2500 series routers throughout this guide.

**Note**

You might need to order a power adapter plate for your router or concentrator to make it compatible with the Cisco RPS. [Table 3-1 on page 3-6](#) lists adapter plates and order numbers.

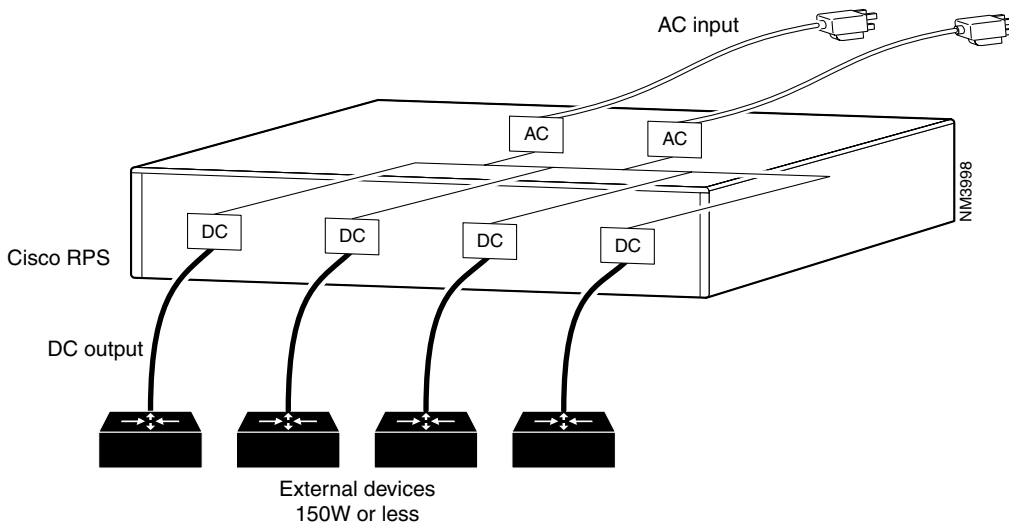
## Quasi-Redundant Configuration

The Cisco RPS provides a quasi-redundant power source for four external devices that use up to 150W DC each. This configuration is allowed for all supported devices. You can use a one-to-one cable (one connector at each cable end) to connect four external devices to the four DC output power modules, as shown in [Figure 1-1](#). The power source is quasi-redundant because there are two AC input power modules for the Cisco RPS and one DC output power module for each external device. The AC input to the Cisco RPS is fully redundant, but the DC output to the external devices is not.


**Note**

This is the only *recommended* configuration for Cisco switches and hubs.

**Figure 1-1** Quasi-Redundant Configuration



## Fully Redundant Configuration

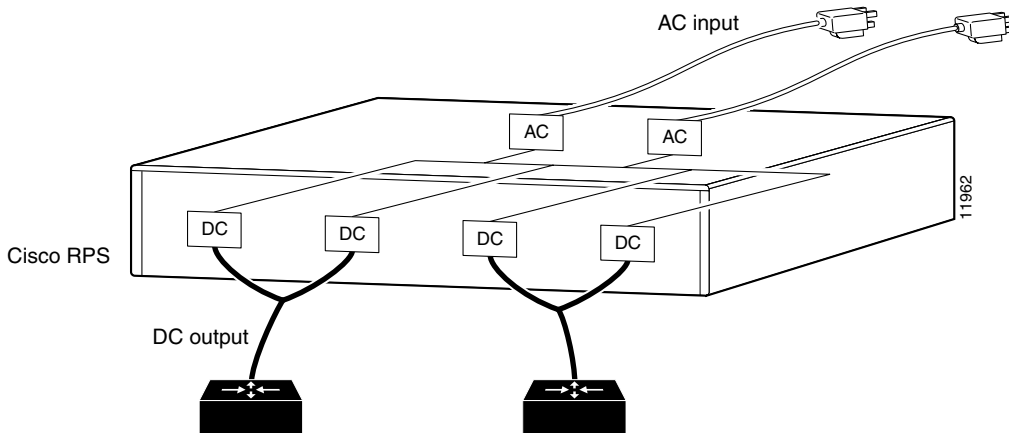
The Cisco RPS can provide a fully redundant power source for two of the supported routers or concentrators. You can use a two-to-one cable (ordered separately) to connect two external devices to the four DC output power modules, as shown in [Figure 1-2](#). The two-to-one cable is a Y-shaped cable with two connectors at one end and one connector at the other end.

In this configuration, the connectors at one end of the Y-shaped cable connect to two Cisco RPS DC output power modules; the single connector on the other end of the cable connects to one external device. The power source is fully redundant, because there are two AC input modules and two DC output power modules connected to each external device. If any power module fails, there is a full backup.

**Note**

This configuration is not supported for switches and hubs.

**Figure 1-2 Fully Redundant Configuration**

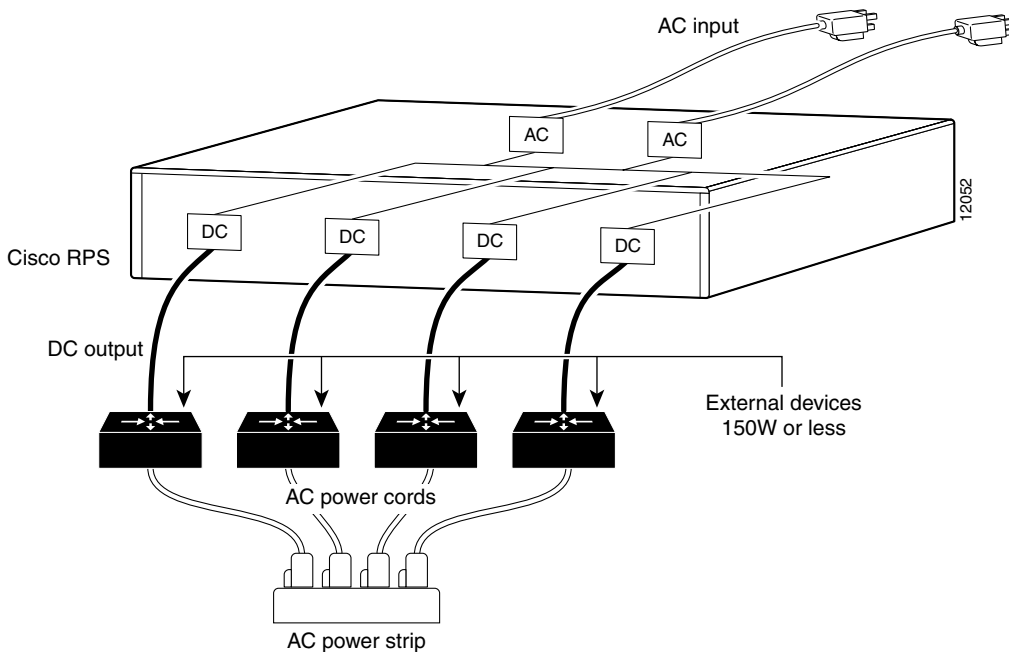


## Redundant with Reboot

By using a mode of operation called redundant with reboot, you can connect more hubs and switches to the Cisco RPS and thereby extend its capacity or provide additional redundancy. Redundancy with reboot works for the following devices only: FastHub 400 series hubs, Catalyst 1900 series and Catalyst 2820 switches, and Catalyst 2900 series and Catalyst 3500 series XL switches. However, this configuration is *not* generally recommended, because a power supply failure will cause an interruption while the hub or switch reboots.

The redundant-with-reboot configuration is shown in [Figure 1-3](#), where a straight-through one-to-one cable connects an external switch or hub to the Cisco RPS while the device is powered by its own internal power supply (the device AC power plug is connected).

**Figure 1-3** Redundant-With-Reboot Configuration



In this configuration, one Cisco RPS can support four devices. The Cisco RPS and the external device internal power supply are both connected.

**Note**

---

If you use this configuration, always power up the external device *before* powering up the Cisco RPS to ensure correct operation. If the Cisco RPS powers up first, the LEDs might not indicate the actual state.

---

After power up, a sense circuit in the Cisco RPS reads that the device has its AC power connected and shuts the Cisco RPS output off, preventing competition between the power supplies.

Normally, the external device internal power supply always provides power. If the internal power system of the hub or switch fails, the device powers down briefly (for approximately 30 seconds) until the Cisco RPS begins supplying power. When the device comes back up, the Cisco RPS is the main power source.

In this configuration, if the Cisco RPS fails or is disconnected, the external device does not power cycle, because its internal power supply has not been disturbed. When both the Cisco RPS and internal power supply are powered, the RPS LED on the external device blinks green, and the LED on the Cisco RPS front panel is off because the Cisco RPS is not supplying power.

Despite 30 seconds of downtime that occur when using redundancy with reboot, this configuration does provide additional redundancy and extends the capacity of the Cisco RPS.

**Note**

---

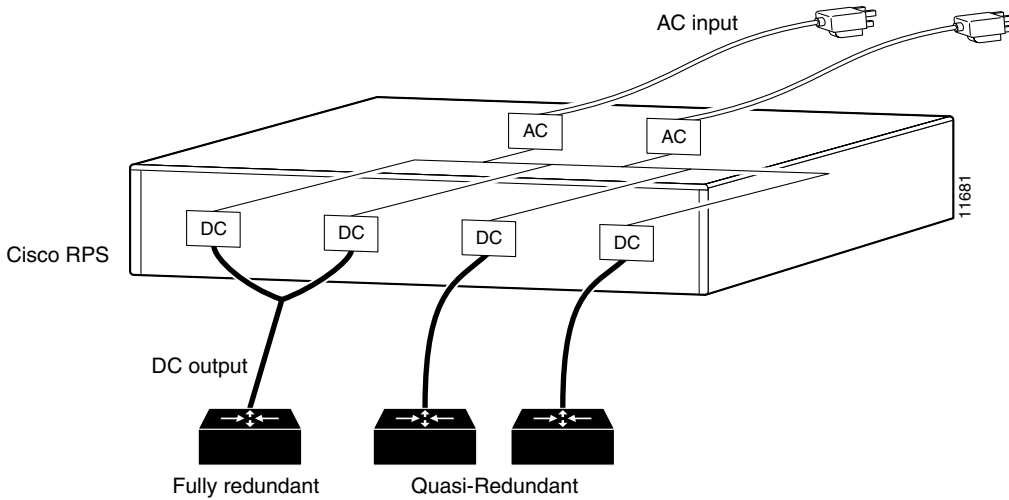
Cisco recommends that you do not use the redundant-with-reboot configuration with the hub or switch connected to both the Cisco RPS and to the AC power plug, because of the 30-second reboot and downtime. If you do use the redundant-with-reboot configuration, always power up the external device before you power up the Cisco RPS to ensure correct operation. When the Cisco RPS powers up first, the LEDs might not indicate the actual state.

---

## Quasi- and Fully Redundant Mixed Configuration

You can mix quasi-redundant and fully redundant configurations for supported devices. For example, two devices can be in quasi-redundant mode while one is in fully redundant mode (see [Figure 1-4](#)).

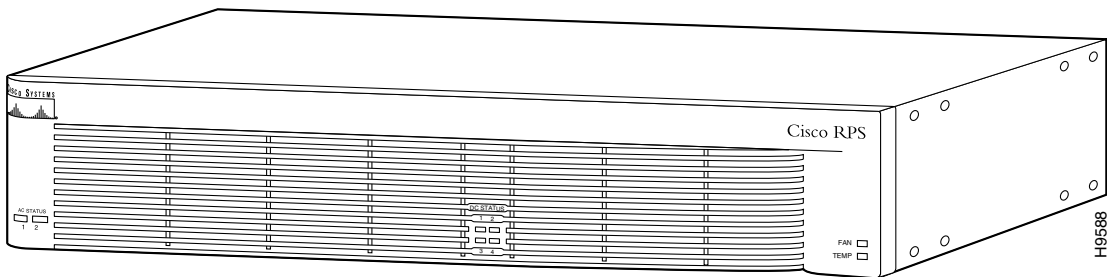
Figure 1-4 Mixed Configuration



## Front and Rear Panel Descriptions

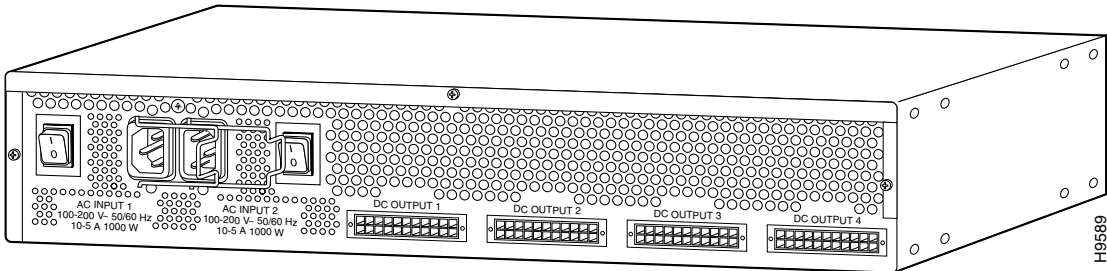
The LEDs on the Cisco RPS front panel show the Cisco RPS operational status. [Figure 1-5](#) shows the front panel of the Cisco RPS.

Figure 1-5 Cisco RPS Front Panel



The Cisco RPS rear panel has two AC power connectors, each with an on/off switch, and four DC connectors for connecting to devices. [Figure 1-6](#) shows the rear panel. See [Chapter 3, “Connection Requirements,”](#) for information about required cables and connectors.

**Figure 1-6 Cisco RPS Rear Panel**



## LEDs

The LEDs on the front panel of the Cisco RPS display the current operating condition of the Cisco RPS:

- AC STATUS LEDs—Two on the left side of the front panel.
- DC STATUS LEDs—Four on the center of the front panel.
- FAN and TEMP LEDs—Both on the right side of the front panel.

When the Cisco RPS is working properly, all LEDs on its front panel are solid green.



### Note

Some external devices also include LEDs that show the operating condition of the Cisco RPS. Refer to the installation guide that accompanied the device for detailed information about the device LEDs.

Figure 1-7 shows the Cisco RPS front panel LEDs, and Table 1-2 explains the meaning of the colors.

Figure 1-7 Cisco RPS LEDs

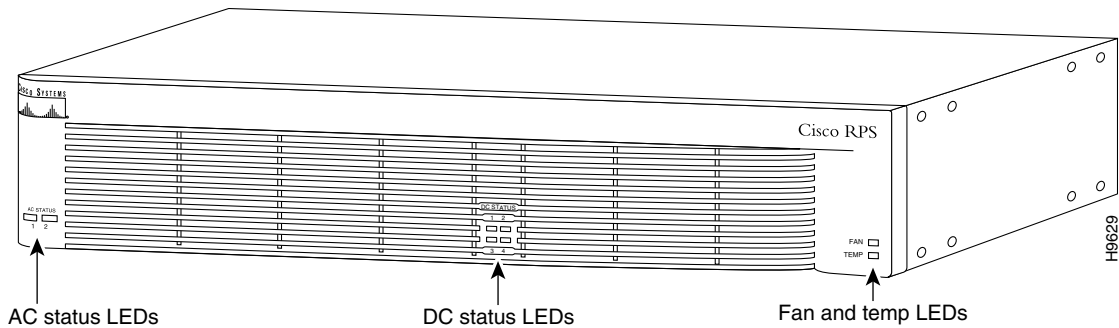


Table 1-2 LED Descriptions

LED Name	Color/State	Description
AC STATUS	Off	AC power is not being supplied to the Cisco RPS, or it is switched off.
	Amber	AC power is being supplied to the Cisco RPS, but the designated AC-input power module has failed.
	Green	The AC-input power module is on and operating correctly.
DC STATUS		<b>Note</b> The DC status LEDs are numbered to correspond to the DC-output connectors on the Cisco RPS rear panel.
	Off	The DC output is powered down at the external device, AC power is not being supplied to the Cisco RPS, or there is no output cable attached to the DC output module.



Table 1-2 LED Descriptions (continued)

LED Name	Color/State	Description
	Amber	The DC output power module has failed.  <b>Note</b> The DC status LED is amber for 10 to 15 seconds after the DC output power module has been connected and the external device has been powered up before it turns green to indicate correct operation.  <b>Note</b> If you are using a Cisco RPS with a revision level lower than Z3 with a Catalyst 3508G or a Catalyst 3548 XL switch, the switch RPS LED and the RPS DC LED of the connector for the switch might display amber (normally indicating a Cisco RPS malfunction) even when the Cisco RPS is functioning properly. The LEDs display correctly for Cisco RPS revision level Z3 or later revision. The label on the bottom of the Cisco RPS shows the revision.
	Green	The DC output power module is on and operating correctly.
FAN	Off	AC power is not being supplied to the Cisco RPS.
	Amber	One or more cooling fans has failed.
	Green	All cooling fans are functioning correctly.
TEMP	Off	AC power is not being supplied to the Cisco RPS.
	Amber	The Cisco RPS internal temperature is exceeding the operating range.
	Green	The Cisco RPS internal temperature is within the operating range.

## Safety Recommendations

Follow these guidelines to guarantee general safety:

- Keep the chassis area clear and dust-free during and after installation.
- Keep tools and chassis components away from walk areas where you or others could fall over them.
- Do not wear loose clothing that could get caught in the chassis. Fasten your tie or scarf and roll up your sleeves.

- Wear safety glasses when working under conditions that might be hazardous to your eyes.
- Do not perform any action that creates a hazard to people or makes the equipment unsafe.

## Safety Warnings

Safety warnings appear throughout this guide in procedures that, if performed incorrectly, might harm you. A warning symbol precedes each warning statement. (For information on safety warnings and translations, see the [“Notes, Cautions, and Warnings”](#) section on page xi.)

## Safety with Electricity



**Warning**

---

**Read the installation instructions before you connect the system to its power source. To see translations of the warnings that appear in this publication, refer to the *Regulatory Compliance and Safety Information* document that accompanied this device.**

---



**Warning**

---

**The device is designed to work with TN power systems. To see translations of the warnings that appear in this publication, refer to the *Regulatory Compliance and Safety Information* document that accompanied this device.**

---



**Warning**

---

**Before working on equipment that is connected to power lines, remove jewelry (including rings, necklaces, and watches). Metal objects will heat up when connected to power and ground and can cause serious burns or weld the metal object to the terminals. To see translations of the warnings that appear in this publication, refer to the *Regulatory Compliance and Safety Information* document that accompanied this device.**

---

**Warning**

This product relies on the building's installation for short-circuit (overcurrent) protection. Make sure that a fuse or circuit breaker is no larger than 120 VAC, 15A U.S. (240 VAC, 10A international) is used on the phase conductors (all current-carrying conductors). To see translations of the warnings that appear in this publication, refer to the *Regulatory Compliance and Safety Information* document that accompanied this device.

**Warning**

This equipment is intended to be grounded. Make sure that the host is connected to earth ground during normal use. To see translations of the warnings that appear in this publication, refer to the *Regulatory Compliance and Safety Information* document that accompanied this device.

**Warning**

Ultimate disposal of this product should be handled according to all national laws and regulations. To see translations of the warnings that appear in this publication, refer to the *Regulatory Compliance and Safety Information* document that accompanied this device.

Follow these guidelines when working on equipment powered by electricity:

- Locate the emergency power-off switch in the room in which you are working. Then, if an electrical accident occurs, you can quickly shut the power off.
- Look carefully for possible hazards in your work area, such as moist floors, ungrounded power extension cables, and missing safety grounds.
- If an electrical accident occurs, proceed as follows:
  - Use caution; do not become a victim yourself.
  - Turn off power to the Cisco RPS.
  - If possible, send another person to get medical aid. Otherwise, determine the condition of the victim and then call for help.
  - Determine if the person needs rescue breathing or external cardiac compressions; then take appropriate action.





## Installing the Cisco RPS

---

You can set the Cisco RPS chassis on a desktop or install it in a rack.



**Warning**

---

**Only trained and qualified personnel should be allowed to install or replace this equipment. To see translations of the warnings that appear in this publication, refer to the *Regulatory Compliance and Safety Information* document that accompanied this device.**

---



**Warning**

---

**Do not work on the system or connect or disconnect cables during periods of lightning activity. To see translations of the warnings that appear in this publication, refer to the *Regulatory Compliance and Safety Information* document that accompanied this device.**

---



**Warning**

---

**Before opening the chassis, disconnect the telephone-network cables to avoid contact with telephone-network voltages. To see translations of the warnings that appear in this publication, refer to the *Regulatory Compliance and Safety Information* document that accompanied this device.**

---



**Warning**

---

**This equipment is intended to be grounded. Ensure that the host is connected to earth ground during normal use. To see translations of the warnings that appear in this publication, refer to the *Regulatory Compliance and Safety Information* document that accompanied this device.**

---

**Warning**

---

**Never defeat the ground conductor or operate the equipment in the absence of a suitably installed ground conductor. Contact the appropriate electrical inspection authority or an electrician if you are uncertain that suitable grounding is available. To see translations of the warnings that appear in this publication, refer to the *Regulatory Compliance and Safety Information* document that accompanied this device.**

---

**Warning**

---

**When installing the unit, the ground connection must always be made first and disconnected last. To see translations of the warnings that appear in this publication, refer to the *Regulatory Compliance and Safety Information* document that accompanied this device.**

---

- Do not work alone if potentially hazardous conditions exist.
- Never assume that power is disconnected from a circuit. Always check.

The Cisco RPS location is extremely important for proper operation. Equipment placed too close together, inadequate ventilation, and inaccessible panels can cause malfunctions and shutdowns and can make maintenance difficult. The following information will help you to plan the location of the chassis.

- Plan for access to both the front and rear panels of the Cisco RPS.
- Make sure that the room where the Cisco RPS operates has adequate ventilation. Remember that electrical equipment generates heat. Ambient air temperature might not cool equipment to acceptable operating temperatures without adequate ventilation. (See [Table A-1 on page A-1.](#))

Use the procedure that best meets your needs:

- [“Setting the Cisco RPS on a Desktop” section on page 2-3](#)
- [“Rack-Mounting the Cisco RPS” section on page 2-3](#)

# Setting the Cisco RPS on a Desktop

**Warning**

**Do not stack the chassis on any other equipment. If the chassis falls, it can cause severe bodily injury and equipment damage. To see translations of the warnings that appear in this publication, refer to the *Regulatory Compliance and Safety Information* document that accompanied this device.**

**Warning**

**This unit is intended for installation in restricted access areas. A restricted access area is where access can only be gained by service personnel through the use of a special tool, lock and key, or other means of security and is controlled by the authority responsible for the location. To see translations of the warnings that appear in this publication, refer to the *Regulatory Compliance and Safety Information* document that accompanied this device.**

To install your chassis on a desktop, perform the following steps:

- Step 1**    Unpack the Cisco RPS.
- Step 2**    Attach the rubber feet from the accessory kit in the round recesses on the chassis bottom.
- Step 3**    Set the Cisco RPS chassis on an appropriate desktop.
- Step 4**    Plug in the Cisco RPS, and turn power on.

**Note**

If you have questions or need assistance, see the [“Obtaining Documentation” section on page xviii](#).

## Rack-Mounting the Cisco RPS

This sections explains how to rack-mount the Cisco RPS in 19-, 23-, 24-inch, or telco equipment racks. Read the following information before rack-mounting your chassis.

# Planning Your Rack-Mount Installation



## Warning

---

**To prevent bodily injury when mounting or servicing this unit in a rack, you must take special precautions to ensure that the system remains stable. The following guidelines are provided to ensure your safety. To see translations of the warnings that appear in this publication, refer to the *Regulatory Compliance and Safety Information* document that accompanied this device.**

---

- This unit should be mounted at the bottom of the rack if it is the only unit in the rack.
- When mounting this unit in a partially filled rack, load the rack from the bottom to the top with the heaviest component at the bottom of the rack.
- If the rack is provided with stabilizing devices, install the stabilizers before mounting or servicing the unit in the rack.

The following information will help you plan your equipment rack installation:

- Enclosed racks must have adequate ventilation. Make sure that the rack is not congested, because each unit generates heat. Heat generated by equipment near the bottom of the rack can be drawn upward into the intake ports of the equipment above. An enclosed rack should have louvered sides and a fan to provide cooling air.
- When mounting a chassis in an open rack, make sure that the rack frame does not block the intake or exhaust ports. If the chassis is installed on slides, check the position of the chassis when it is seated in the rack.
- Baffles can isolate exhaust air from intake air, which also helps to draw cooling air through the chassis. The best placement of the baffles depends on the airflow patterns in the rack, which can be found by experimenting with different configurations.
- When equipment installed in a rack (particularly in an enclosed rack) fails, try operating the equipment by itself, if possible. Power off other equipment in the rack and in adjacent racks to allow the unit under test a maximum of cooling air and clean power.
- Install the Cisco RPS and the external device to which it will connect in adjacent shelves in a rack.



## Tools and Equipment Required

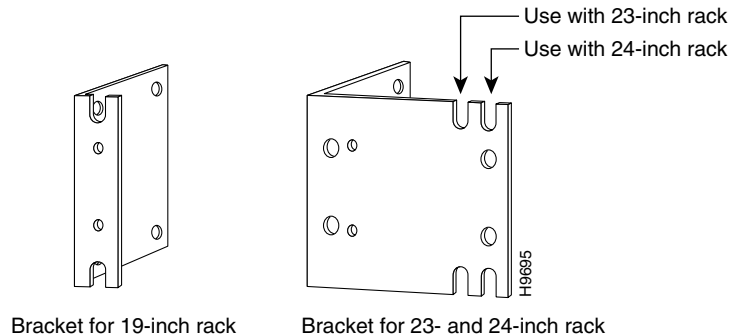
You need the following tools and equipment to rack-mount the Cisco RPS:

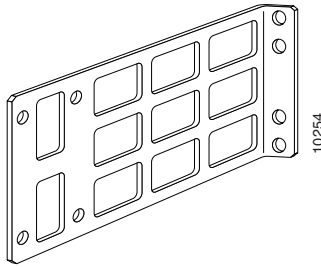
- Number 2 Phillips screwdriver (not included)
- Screws for attaching the Cisco RPS to the rack (not included)
- Rack-mount brackets (see [Figure 2-1](#) and [Figure 2-2](#)):
  - One set of 19-inch brackets (ACS-3640RM-19=) ships with the Cisco RPS.
  - Order 23- or 24-inch brackets (ACS-3640RM-24=), as needed.
  - Order telco brackets (AS52/3RM-TELCO-19=), as needed.

## Identifying Rack-Mount Brackets

[Figure 2-1](#) shows the 19-, 23-, and 24-inch brackets; [Figure 2-2](#) shows the telco bracket.

**Figure 2-1 19-, 23-, and 24-Inch Rack-Mount Brackets**



**Figure 2-2 Telco Bracket**

## Attaching Brackets

To install the Cisco RPS in a rack, attach the brackets in one of the following ways:

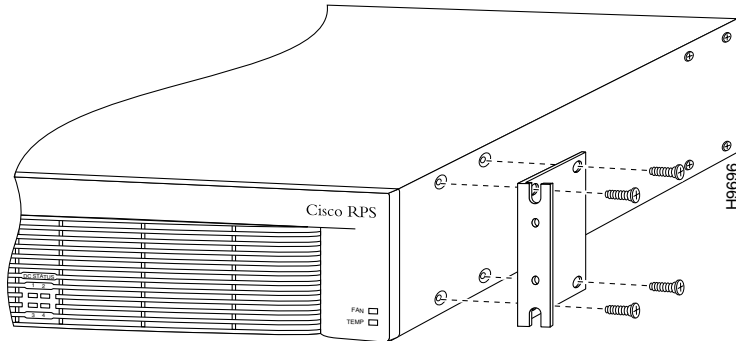
- With the Cisco RPS front panel forward (see [Figure 2-3](#)).
- With the Cisco RPS rear panel forward (see [Figure 2-4](#)).
- In a center-mount telco rack (see [Figure 2-5](#)).

**Note**

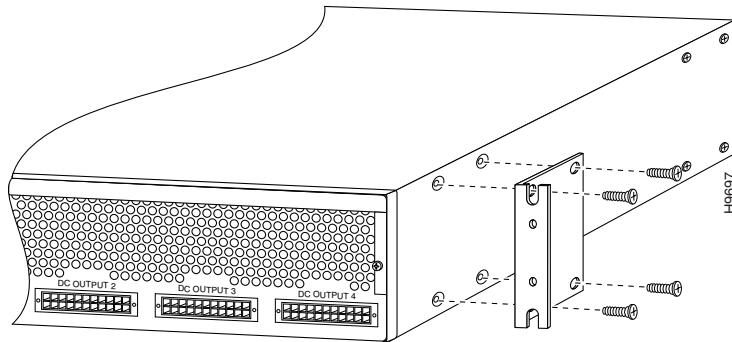
---

Although [Figure 2-3](#) and [Figure 2-4](#) show 19-inch brackets, the procedure is the same for 23-inch, 24-inch, and telco brackets.

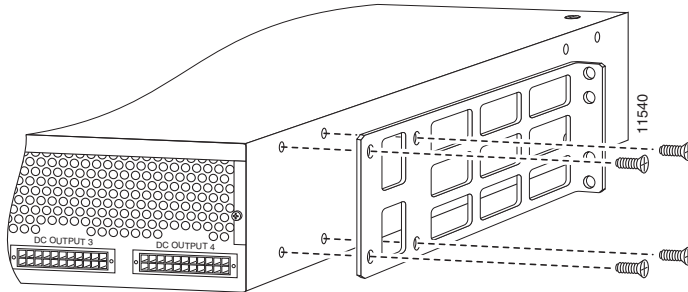
---

**Figure 2-3 Bracket Installation—Front Panel Forward**

Note: The second bracket attaches to the other side of the chassis.

**Figure 2-4 Bracket Installation—Rear Panel Forward**

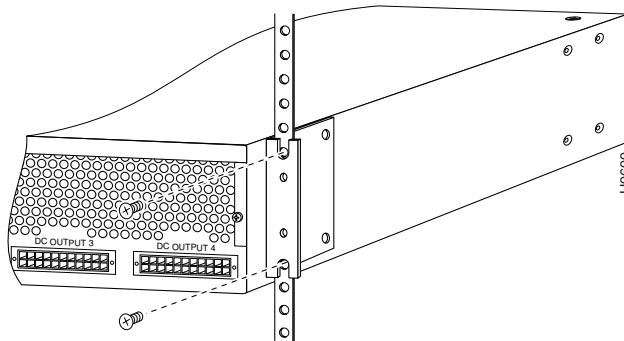
Note: The second bracket attaches to the other side of the chassis.

**Figure 2-5 Telco Bracket Installation—Rear Panel Forward**

Note: The second bracket attaches to the other side of the chassis.  
The brackets can also be installed with the Cisco RPS front panel forward.

## Mounting the Chassis in a Rack

After the brackets are secured to the chassis, use your own screws to attach the chassis to the rack, as shown in [Figure 2-6](#).

**Figure 2-6 Attaching the Chassis to a Rack—Rear Panel Forward**

Note: The second bracket attaches to the rack at the other side of the chassis.



## Connection Requirements

---

This chapter describes the equipment required to connect the Cisco RPS to external devices. The Cisco RPS includes two fully redundant AC input power modules and four DC output power modules for connection to external devices. The Cisco RPS supports a quasi-redundant configuration for all devices, fully redundant configuration for the referenced Cisco routers and concentrator, and redundant-with-reboot configurations for the referenced hubs and switches. However, the redundant-with-reboot configuration is not recommended because a power supply failure will cause an interruption while the hub or switch reboots. For an explanation of power source configurations, refer to [Chapter 1, “Overview.”](#)



### Caution

---

The Cisco RPS AC input power modules are power-factor-corrected to comply with certain International Electrotechnical Commission (IEC) standards. Do not connect the Cisco RPS to an uninterruptible power supply (UPS) that has not been tested and designed for power-factor-corrected power systems. Do not connect the Cisco RPS to a ferro-resonant transformer. If you do either of these things, you could damage the Cisco RPS.

---

This chapter contains the following sections:

- [Tools and Equipment Required, page 3-2](#)
- [Cabling Options, page 3-2](#)
- [Ordering Cables, page 3-3](#)
- [Upgrade Kit with Power Adapter Plate for Routers and Concentrators, page 3-6](#)

# Tools and Equipment Required

You might need to order the following equipment:

- One-to-one 22-pin to 8-pin cable—Needed for Cisco 2500 series routers and Cisco MC3810 multiservice concentrators
- Y-cable—Needed for fully redundant power configurations
- Upgrade kit—Needed for routers that originally came with AC or DC power supplies (Cisco 2500 and Cisco 2600 series routers; Cisco 3620, Cisco 3640, and Cisco 3725 routers; Cisco 4000 series routers; and the Cisco MC3810 multiservice concentrator)

## Cabling Options

The external devices have different configuration and cabling options outlined below and are discussed in detail under the referenced section of this manual:

- The Cisco 1516M hub (HP 10BASE-T Hub-16M) only supports a one-to-one cable for quasi-redundant configuration. This hub does not support connection of its AC power cable for redundancy with reboot or the use of the Y-cable for full redundancy.
- FastHub 400 series 100BASE-T hubs support:
  - One-to-one cable for quasi-redundancy
  - One-to-one cable with the switch AC power cable connected for redundancy with reboot (not recommended)

Refer to the [“Connecting Hubs” section on page 4-3](#) for illustrations and procedures.

- Catalyst 1900 series switches, Catalyst 2820 switches, Catalyst 2900 series XL switches, and Catalyst 3500 series XL switches support:
  - One-to-one cable for quasi-redundancy
  - One-to-one cable with the switch AC power cable connected for redundancy with reboot (not recommended)

See the [“Connecting Switches” section on page 4-7](#) for illustrations and procedures.

- Cisco 2500 and Cisco 2600 series routers; Cisco 3620, Cisco 3640, and Cisco 3725 routers; Cisco 4000 series routers; and the Cisco MC3810 multiservice concentrator support:
  - One-to-one cable for quasi-redundancy
  - Two-to-one Y-cable for full redundancy

Refer to the [“Connecting Routers and the Cisco MC3810 Concentrator” section on page 4-13](#) for illustrations and procedures.

## Ordering Cables

The Cisco RPS ships in either of the following configurations:

- With cables (Cisco RPS number PWR600-AC-RPS-CAB)—Includes four one-to-one (22-pin to 18-pin) cables for connecting to hubs and switches or for quasi-redundant support for Cisco 2600 series routers; Cisco 3620, Cisco 3640, and Cisco 3725 routers; and Cisco 4000 series routers.
- Without cables (Cisco RPS number PWR600-AC-RPS-NCAB)—Cables must be ordered separately:
  - One-to-one (22-pin to 18-pin) cables for connecting to hubs and switches or for quasi-redundant support for Cisco 2600 series routers; Cisco 3620, Cisco 3640, and Cisco 3725 routers; and Cisco 4000 series routers
  - One-to-one (22-pin to 8-pin) cables for quasi-redundant support for Cisco 2500 series routers and Cisco MC3810 multiservice concentrators
  - Two-to-one Y cables (22-pin to 18-pin, or 22-pin to 8-pin) for fully redundant support for routers or concentrators only



---

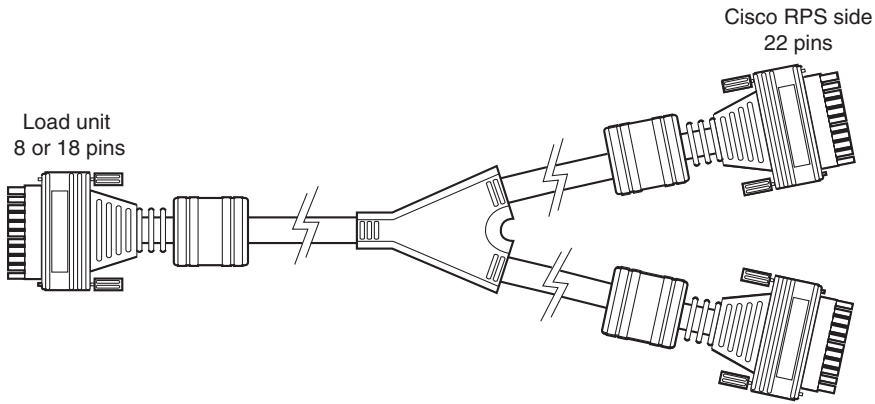
**Note**

The fully redundant configuration is supported only for routers, not for hubs or switches.

---

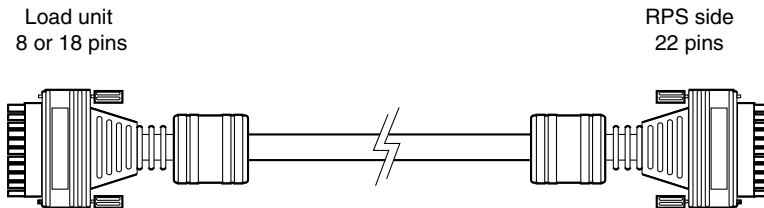
[Figure 3-1](#) and [Figure 3-2](#) show the cables you can order, and [Table 3-1](#) includes cable descriptions and lists the corresponding product order numbers. For ordering information, contact 800 553-6387, 408 526-7208, or [cs-rep@cisco.com](mailto:cs-rep@cisco.com). See also the [“Obtaining Documentation” section on page xviii](#).

## Ordering Cables

**Figure 3-1 Two-to-One Y-Shaped Cable**

11538

Product number	External device
CAB-RPSY-2208	Cisco 2500 series routers and Cisco MC3810 multiservice concentrators
CAB-RPSY-2218	Cisco 2600 series routers, Cisco 3620, Cisco 3640, and Cisco 3725 routers, and Cisco 4000 series routers

**Figure 3-2 One-to-One Cable**

11539

Product number	External device
CAB-RPS-2208	Cisco 2500 series routers and Cisco MC3810 multiservice concentrator
CAB-RPS-2218	All others



**Table 3-1 Cable Order Numbers**

<b>Redundancy Configuration</b>	<b>For Use With</b>	<b>Cable Description</b>	<b>Cable Order Number</b>
Quasi-redundant	Cisco 1516M hub (HP 10BASE-T Hub-16M), FastHub 400 series hubs, Catalyst 1900 series and Catalyst 2820 switches, Catalyst 2900 series and Catalyst 3500 series XL switches, Cisco 2600 series routers, Cisco 3620, Cisco 3640, and Cisco 3725 routers, and Cisco 4000 series routers	One-to-one cable, 22-pin to 18-pin, 4 ft (1.22 m) <sup>1</sup>	CAB-RPS-2218=
	Cisco 2500 series routers and access servers and Cisco MC3810 multiservice concentrators	One-to-one cable, 22-pin to 8-pin, 4 ft (1.22 m) <sup>1</sup>	CAB-RPS-2208=
Fully redundant	Cisco 2600 series routers, Cisco 3620, Cisco 3640, and Cisco 3725 routers, and Cisco 4000 series routers	Two-to-one cable, 22-pin to 18-pin, 4 ft (1.22 m) <sup>1</sup>	CAB-RPSY-2218=
	Cisco 2500 series routers and access servers and Cisco MC3810 multiservice concentrators	Two-to-one cable, 22-pin to 8-pin, 4 ft (1.22 m) <sup>1</sup>	CAB-RPSY-2208=
Redundant with reboot <sup>2</sup>	FastHub 400 series hubs, Catalyst 1900 series and Catalyst 2820 switches, and Catalyst 2900 series and Catalyst 3500 series XL switches	One-to-one cable, 22-pin to 18-pin, 4 ft (1.22 m) <sup>1</sup>	CAB-RPS-2218=

1. The cables come in only one length. Custom cable-lengths are not available. Excessive voltage drop and marginal or failed operation can occur with cables of different lengths. Use of cables other than the ones listed can cause damage to the Cisco RPS or external device.
2. This configuration is *not* recommended due to the 30-second reboot and downtime.

# Upgrade Kit with Power Adapter Plate for Routers and Concentrators

External devices operated with the Cisco RPS must have a Cisco RPS connector. Cisco 2600 series routers, Cisco 3620, Cisco 3640, and Cisco 3725 routers, and Cisco 4000 series routers, and the Cisco MC3810 concentrator do not automatically ship with an RPS connector.



## Note

The FastHub 400 series hubs, Cisco 1516M hub (HP 10ASE-T Hub-16M), Catalyst 1900 series and Catalyst 2820 switches, and Catalyst 2900 series and Catalyst 3500 series XL switches ship with an RPS connector and do not require a power adapter plate.

If you did not order your router or concentrator with a Cisco RPS connector installed, you must order a power adapter plate that provides compatibility and must install the plate in place of your existing power supply.

If you need to order a power adapter plate for your router or concentrator, see [Table 3-2](#), which lists adapter plates and corresponding product order numbers. Contact Cisco Customer Service at 800 553-6387, 408 526-7208, or [cs-rep@cisco.com](mailto:cs-rep@cisco.com) for ordering information. (See also the [“Obtaining Documentation”](#) section on page xviii.)

**Table 3-2 Power Adapter Plate Product Numbers**

Description	Product Number
Cisco 2500 series, Cisco MC3810 adapter plate	ACS-2500RPS=
Cisco 2600 series adapter plate	ACS-2600RPS=
Cisco 3620 adapter plate	ACS-3620RPS=
Cisco 3640 adapter plate	ACS-3640RPS=
Cisco 3725 adapter plate	ACS-3725RPS=
Cisco 4000 series adapter plate	ACS-4000RPS=

Device-specific instructions for installing the RPS adapter plate are shipped with the plate and are also available on Cisco.com at <http://www.cisco.com>.



## Connecting the Cisco RPS

---

This chapter provides instructions on connecting your external device to the Cisco RPS. The chapter is divided into the following major sections:

- [Power Considerations, page 4-1](#)
- [Connecting Hubs, page 4-3](#)
- [Connecting Switches, page 4-7](#)
- [Connecting Routers and the Cisco MC3810 Concentrator, page 4-13](#)

### Power Considerations

Before connecting to external devices, read the power warnings below. We recommend that you disconnect all power before beginning.



**Note**

---

If you want to connect an additional external device to a Cisco RPS that is already powered up, you can do so without interrupting power to the Cisco RPS or any other connected external devices. Be sure to connect your cable to the Cisco RPS first and then to the external device. However, in a redundant-with-reboot configuration, to ensure proper operation, you must power up the switch or hub *before* powering up the Cisco RPS. Therefore, always connect the switch to AC power before you connect it to the Cisco RPS. Failure to follow the proper power-up sequence can result in incorrect LED displays.

---

**Note**

---

A catalyst switch might reload when changing from RPS power to internal power. This can occur on any catalyst switch, except the 3560-E or 3750-E switch, connected to one of the following: Redundant, Power Supplies, PWR 300-AC-RPS-NI, PWR-600-AC-RPS-NI, and RPS2300. To prevent unscheduled downtime, the switch should be powered off during a maintenance window.

---

**Warning**

---

**Attach only the Cisco RPS (model PWR600-AC-RPS) to the RPS receptacle. To see translations of the warnings that appear in this publication, refer to the *Regulatory Compliance and Safety Information* document that accompanied this device.**

---

**Warning**

---

**Before performing any of the following procedures, ensure that power is removed from the DC circuit. To ensure that all power is OFF, locate the circuit breaker on the panel board that services the DC circuit, switch the circuit breaker to the OFF position, and tape the switch handle of the circuit breaker in the OFF position. To see translations of the warnings that appear in this publication, refer to the *Regulatory Compliance and Safety Information* document that accompanied this device.**

---

**Warning**

---

**Before working on a system that has an on/off switch, turn OFF the power and unplug the power cord. To see translations of the warnings that appear in this publication, refer to the *Regulatory Compliance and Safety Information* document that accompanied this device.**

---

**Warning**

---

**This unit might have more than one power cord. To reduce the risk of electric shock, disconnect the two power supply cords before servicing the unit. To see translations of the warnings that appear in this publication, refer to the *Regulatory Compliance and Safety Information* document that accompanied this device.**

---

# Connecting Hubs

This section provides illustrations and cabling information for connecting the Cisco RPS to the following hubs:

- Cisco 1516M hub (HP 10BASE-T Hub-16M) ([Figure 4-1](#))
- FastHub 400 series hubs ([Figure 4-2](#))

**Note**

---

The Cisco RPS can also be used with the older FastHub 100, 200, and 300 series hubs.

---

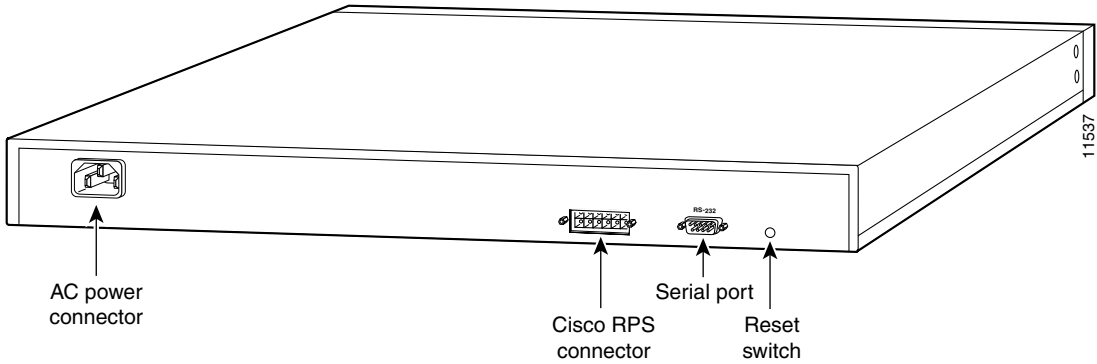
All hubs can use the one-to-one cable configuration for quasi-redundancy. The FastHub 400 series also supports the option of connecting the AC power cord for redundancy with reboot, although this configuration is not recommended. The use of a Y-cable for full redundancy is not supported.

The HP 10BASE-T Hub-16M does not support redundancy with reboot and does not support use of the Y-cable for full redundancy.

To connect hubs to the Cisco RPS, perform these steps:

- 
- Step 1** Disconnect the AC power cord on the hub.
- Step 2** Connect one end of the one-to-one cable to the Cisco RPS connector on the hub rear panel. (For connector locations, see [Figure 4-1](#) and [Figure 4-2](#).)
- Step 3** Connect the other end of the cable to a Cisco RPS rear-panel connector as shown in [Figure 4-3](#).

**Figure 4-1 Cisco 1516M Hub (HP 10BASE-T Hub-16M) Rear Panel**



**Figure 4-2 FastHub 400 Rear Panel**

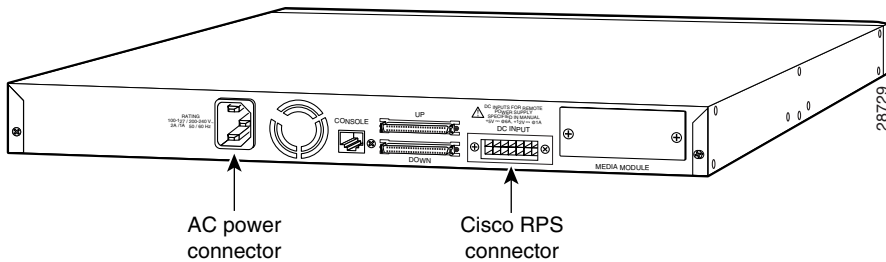
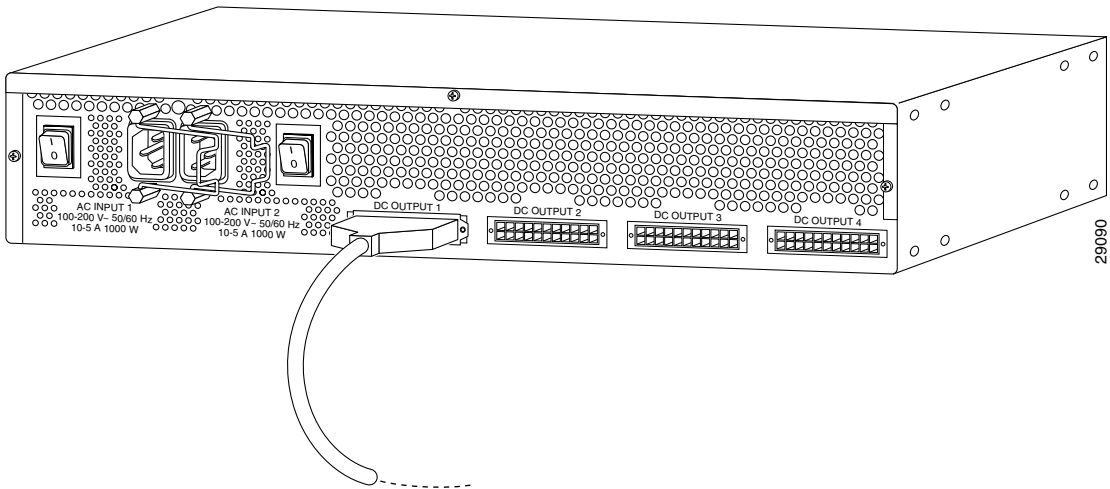
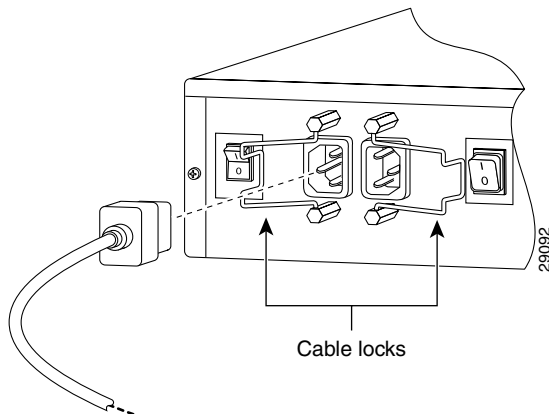


Figure 4-3 Connecting the One-to-One Cable to the Cisco RPS



- Step 4** On the Cisco RPS rear panel, connect an AC power cable to either or both of the power connectors. Use the cable locks on the Cisco RPS to lock the cables in place. (See [Figure 4-4](#).)

Figure 4-4 Connecting the AC Power Cables to the Cisco RPS



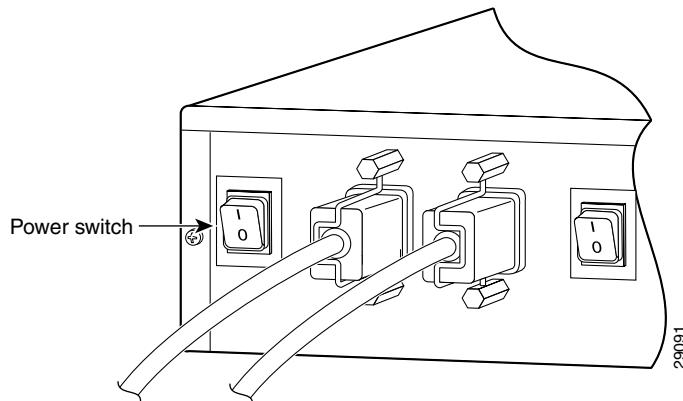
- Step 5** Connect the other end of the Cisco RPS AC power cable into an AC power outlet.
- Step 6** If you are using the redundant-with-reboot configuration (not recommended), power up the switch by connecting the hub AC power cord to an AC power outlet.



**Note** If you use the redundant-with-reboot configuration, always power up the hub *before* you power up the Cisco RPS.

- Step 7** Power up the Cisco RPS. There is one power switch for each AC input power module. Make sure that the power switch is in the ON (I) position for each AC power module used. (See [Figure 4-5](#).)

**Figure 4-5 Powering Up the Cisco RPS**



The Cisco RPS provides power in 10 to 15 seconds. The Cisco RPS is working properly when all its front-panel LEDs are solid green. If the external device does not power up, refer to [Chapter 5, “Troubleshooting the Cisco RPS.”](#)



# Connecting Switches

The Catalyst 1900 series and Catalyst 2820 series switches and the Catalyst 2900 series and Catalyst 3500 series XL switches can use:

- One-to-one cable for quasi-redundancy
- or
- One-to-one cable with the switch AC power cable connected for redundancy with reboot (not recommended)

To connect switches to the Cisco RPS, perform these steps:

- 
- Step 1** Disconnect the AC power cord on the switch.
- Step 2** Connect one end of the one-to-one cable to the Cisco RPS connector on the switch rear panel. (For connector locations, see [Figure 4-6](#) through [Figure 4-12](#).)

**Figure 4-6 Catalyst 1900 Switch Rear Panel**

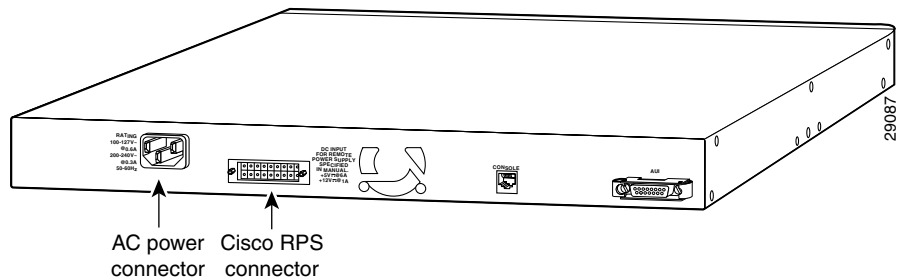


Figure 4-7 Catalyst 2820 Switch Rear Panel

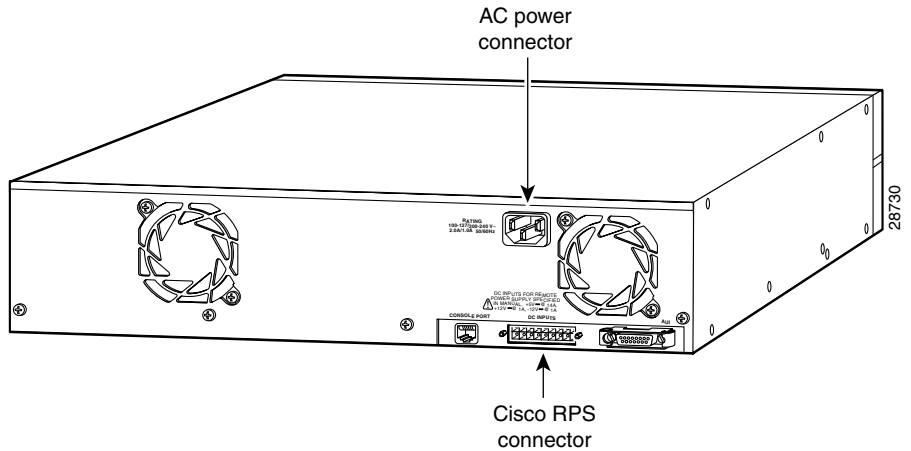


Figure 4-8 Catalyst 2912 XL, Catalyst 2924 XL, and Catalyst 2924C XL Switch Rear Panel

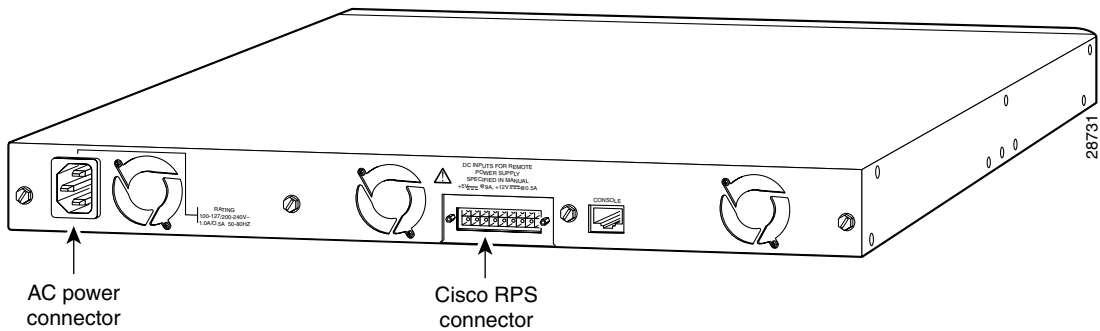


Figure 4-9 Catalyst 2912M XL and Catalyst 2924M XL Switch Rear Panel

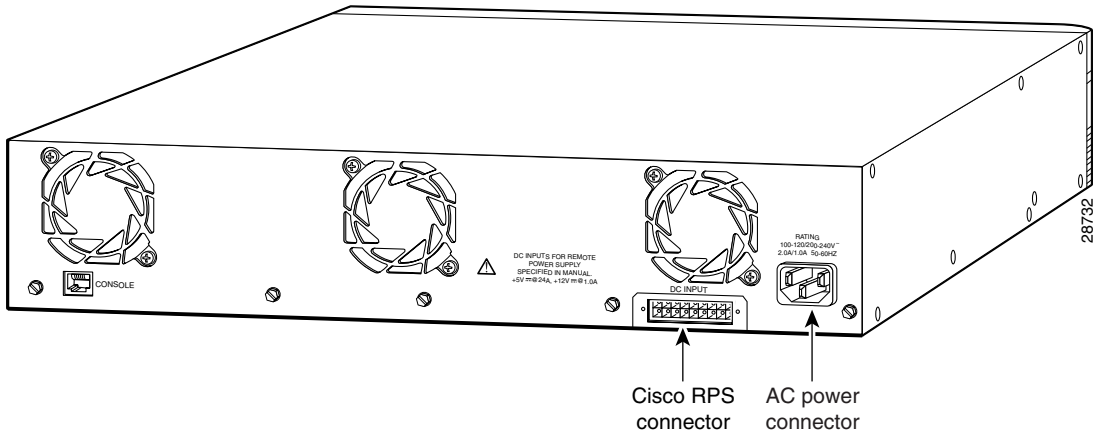
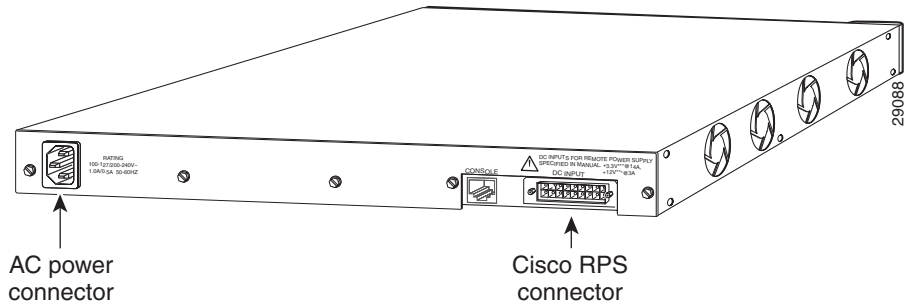
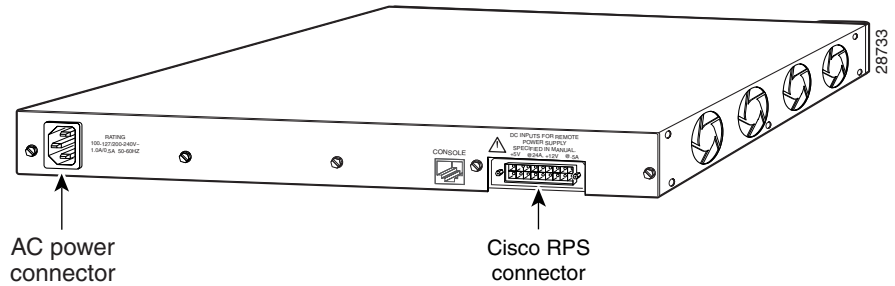
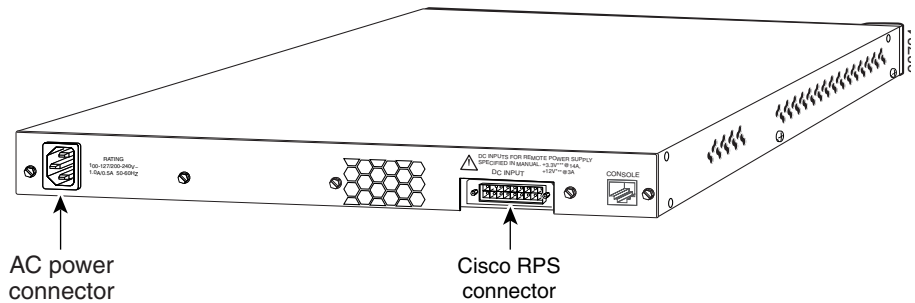


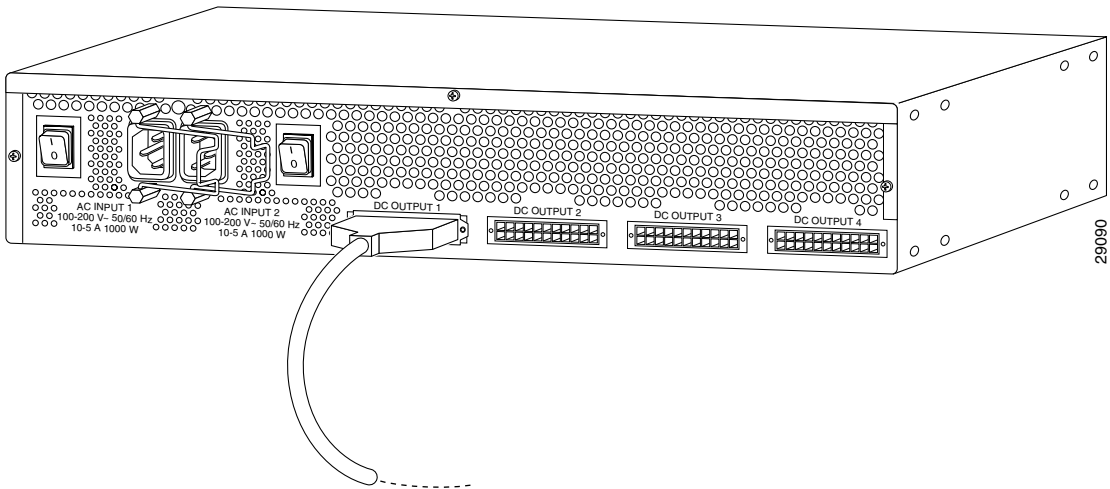
Figure 4-10 Catalyst 3508G XL Switch Rear Panel



**Figure 4-11 Catalyst 3512 XL and Catalyst 3524 XL Switch Rear Panel****Figure 4-12 Catalyst 3548 XL Switch Rear Panel**

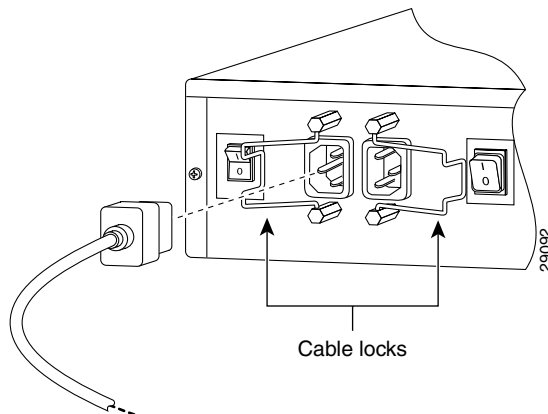
- Step 3** Connect the other end of the one-to-one cable to the Cisco RPS rear-panel connector, as shown in [Figure 4-13](#).

Figure 4-13 Connecting the One-to-One Cable to the Cisco RPS



- Step 4** On the Cisco RPS rear panel, connect an AC power cable to either or both of the power connectors. Use the cable locks on the Cisco RPS to lock the cables in place. (See [Figure 4-14](#).)

Figure 4-14 Connecting the AC Power Cables to the Cisco RPS



- Step 5** Connect the other end of the Cisco RPS AC power cable into an AC power outlet.

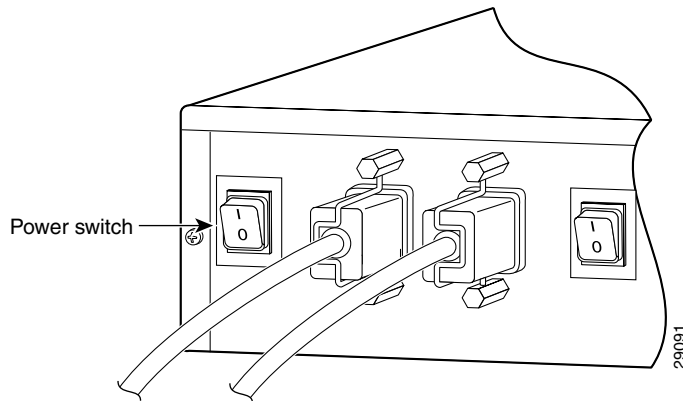
- Step 6** If you are using the redundant-with-reboot configuration (not recommended), power up the switch by connecting the switch AC power cord into an AC power outlet.



**Note** If you use the redundant-with-reboot configuration, always power up the switch *before* you power up the Cisco RPS.

- Step 7** Power up the Cisco RPS. There is one power switch for each of the AC input power modules. Make sure that the power switch for each connected AC cable is in the ON (I) position. (See [Figure 4-15](#).)

**Figure 4-15 Powering Up the Cisco RPS**



The Cisco RPS provides power in 10 to 15 seconds. The Cisco RPS is working properly when all its front panel LEDs are solid green. If the external device does not power up, refer to [Chapter 5, “Troubleshooting the Cisco RPS.”](#)



**Note** If you are using a Cisco RPS with a revision level lower than Z3 with a Catalyst 3508G or a Catalyst 3548 XL switch, the switch RPS LED and the RPS DC LED might display amber (normally indicating Cisco RPS malfunction) even when the

Cisco RPS is functioning properly. The LEDs display correctly for Cisco RPS revision level Z3 or later revision. The label on the bottom of the Cisco RPS shows the revision level.

---

---

## Connecting Routers and the Cisco MC3810 Concentrator

This section provides illustrations and cabling information for connecting the Cisco RPS to Cisco 2500 series and Cisco 2600 series routers; Cisco 3620, Cisco 3640, and Cisco 3725 routers; Cisco 4000 series routers and Cisco MC3810 multiservice concentrators. All these devices use one of the following cables:

- One-to-one cable for quasi-redundancy
- Two-to-one Y-cable for full redundancy

The Cisco 2800 series routers, unless otherwise specified, also support connection to the Cisco\_RPS.



### Note

If you did not order your router or concentrator with a Cisco RPS connector installed, you must order a power adapter plate and must install it in place of your existing power supply.

If you need to order a power adapter plate, see [Table 3-1 on page 3-5](#), which lists adapter plates and corresponding product order numbers. Contact Cisco Customer Service at 800 553-6387 or 408 526-7209 for ordering information. (See also the [“Obtaining Documentation” section on page xviii](#).)

Device-specific instructions for installing the Cisco RPS adapter plate are shipped with the plate and are also available on Cisco.com at <http://www.cisco.com>.

---



### Note

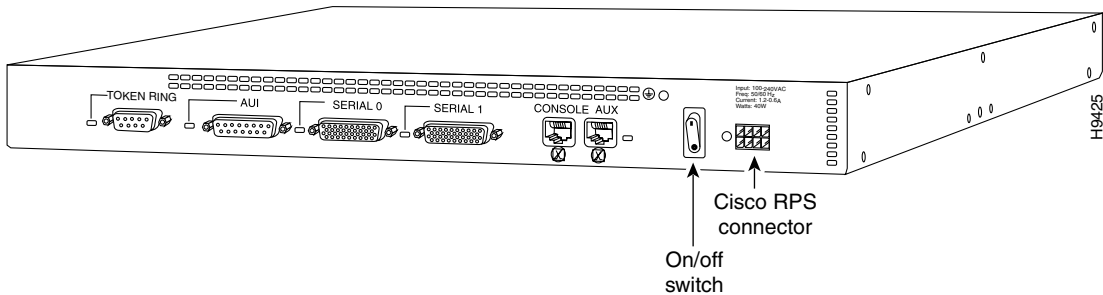
Cisco IOS Software Release 11.2(7)P or later release is required when using the Cisco RPS with Cisco 3620, Cisco 3640, or Cisco 3725 routers.

---

To connect a router or multiservice concentrator to the Cisco RPS, perform the following steps:

- Step 1** Power off the router or concentrator by pressing the power switch to the OFF (O) position.
- Step 2** Connect one end of the one-to-one cable or Y-cable to the Cisco RPS connector on the rear panel of the router or concentrator, as shown in [Figure 4-16](#) through [Figure 4-21](#).

**Figure 4-16 Cisco 2500 Series Router Rear Panel**



**Figure 4-17 Cisco 2600 Series Router Rear Panel**

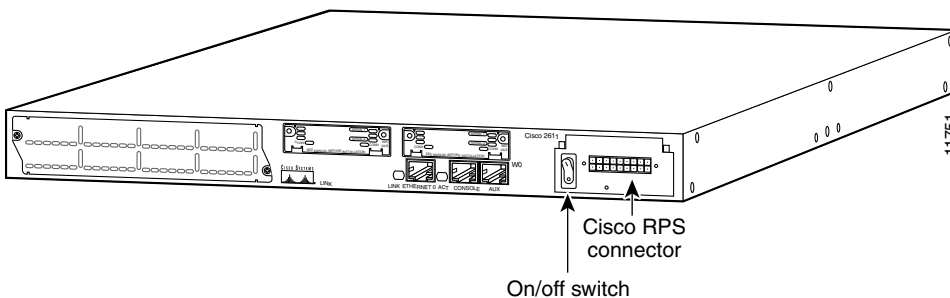




Figure 4-18 Cisco 3620 Router Rear Panel

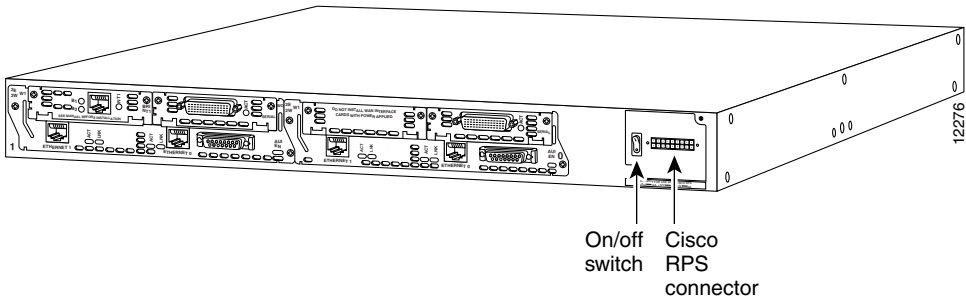


Figure 4-19 Cisco 3640 Router Rear Panel

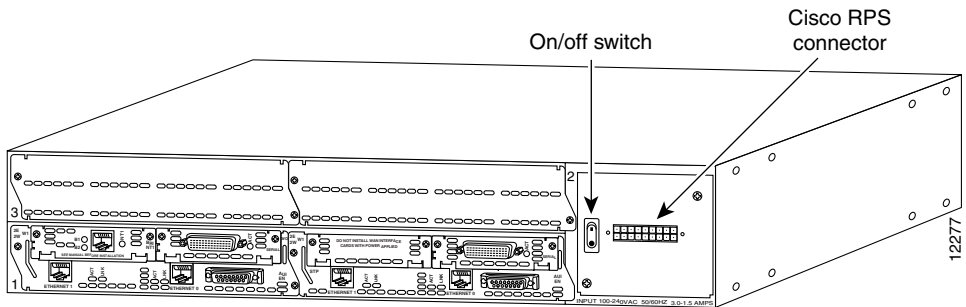


Figure 4-20 Cisco 4000 Series Router Rear Panel

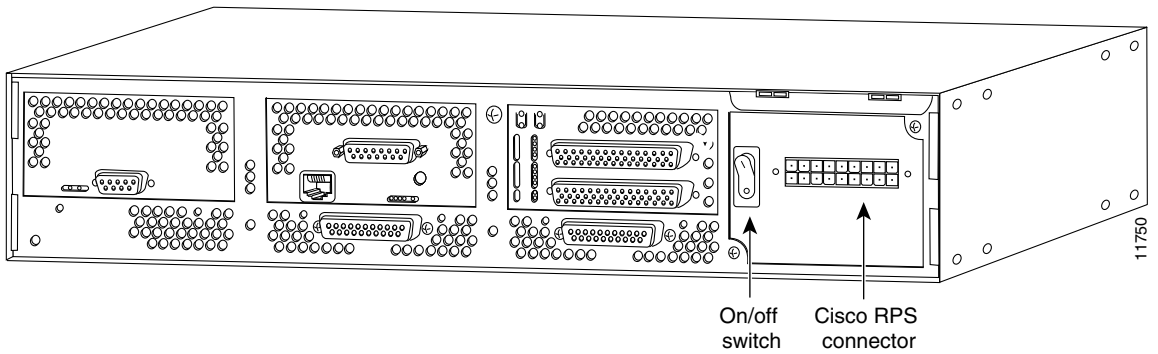
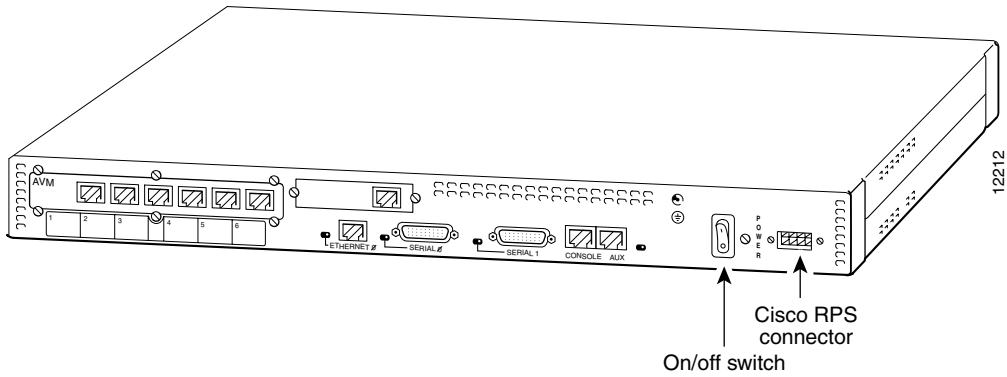
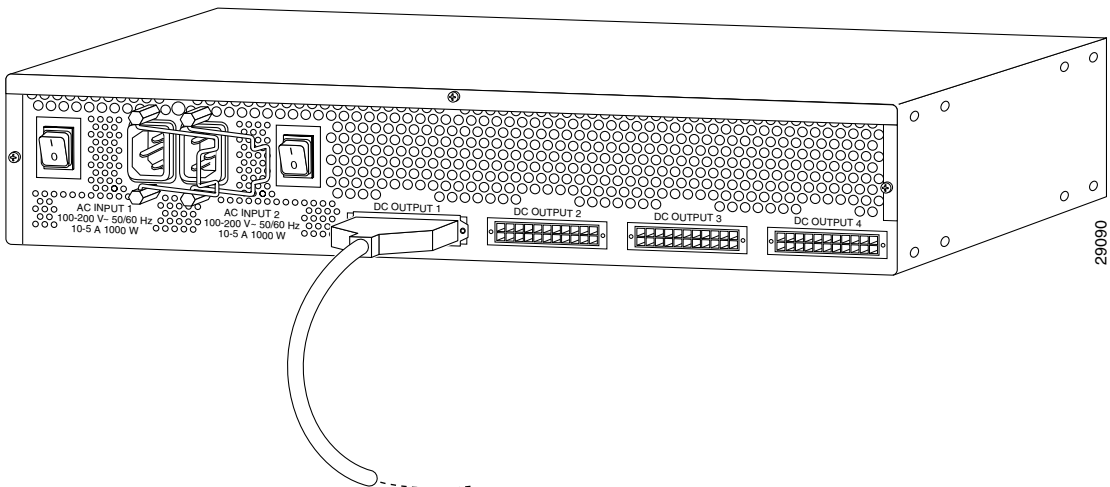


Figure 4-21 Cisco MC3810 Multiservice Concentrator Rear Panel

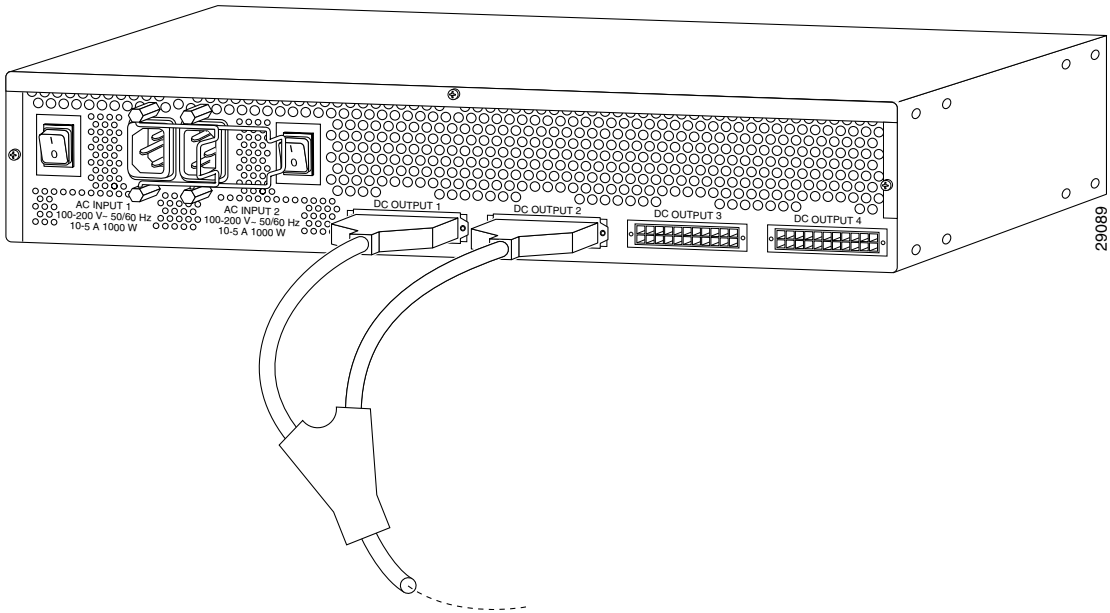


- Step 3** Connect the other end of the one-to-one or Y-cable to the rear panel connector on the Cisco RPS, as shown in [Figure 4-22](#) and [Figure 4-23](#).

Figure 4-22 Connecting a One-to-One Cable for Quasi-Redundant Power

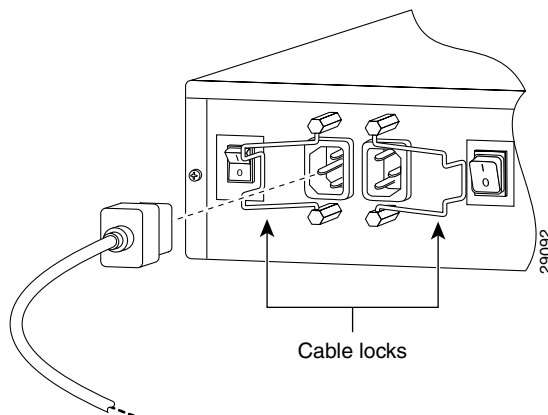


**Figure 4-23** Connecting a Two-to-One Y-Cable for Fully Redundant Power



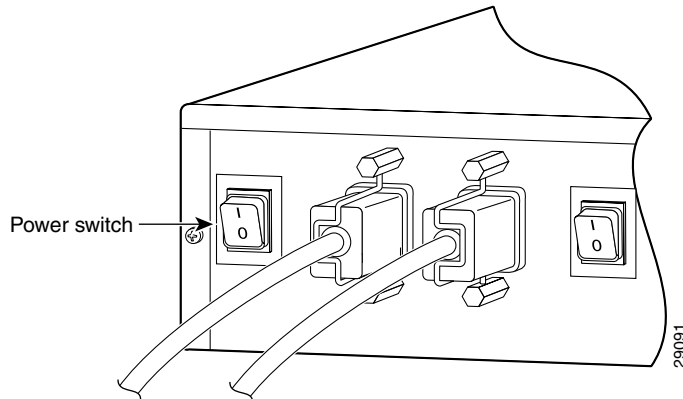
- Step 4** On the rear panel of the Cisco RPS, connect an AC power cable to either or both of the power connectors. Use the cable locks on the Cisco RPS to lock the cables in place. (See [Figure 4-24](#).)

**Figure 4-24** Connecting the AC Power Cables to the Cisco RPS



- Step 5** Connect the other end of the Cisco RPS AC power cable into a grounded AC power outlet.
- Step 6** Power up the Cisco RPS. There is one power switch for each of the AC input power modules. Make sure that the power switch for each connected AC cable is in the ON (I) position. (See [Figure 4-25](#).)

**Figure 4-25 Powering Up the Cisco RPS**



- Step 7** Power on the router or concentrator by pressing the power switch to the ON (I) position.
- The Cisco RPS is on and provides power to the external device in 10 to 15 seconds. The Cisco RPS is working properly when all its front-panel LEDs are solid green. If the external device does not power up, see [Chapter 5, "Troubleshooting the Cisco RPS."](#)
-



## Troubleshooting the Cisco RPS

---

The key to troubleshooting is to isolate the problem to a specific subsystem. Start by reading the LEDs on the front panel of the Cisco RPS and any error messages displayed on the external device console. If you are unable to resolve the problem, refer to the [“Getting Technical Support” section on page 5-14](#).

This chapter contains the following sections:

- [Reading the LEDs, page 5-1](#)
- [Displaying Status, page 5-5](#)
- [Error Messages on Cisco 2600 Series and Cisco 3620, Cisco 3640, and Cisco 3725 Routers, page 5-6](#)
- [Replacing an External Device, page 5-13](#)
- [Getting Technical Support, page 5-14](#)

### Reading the LEDs

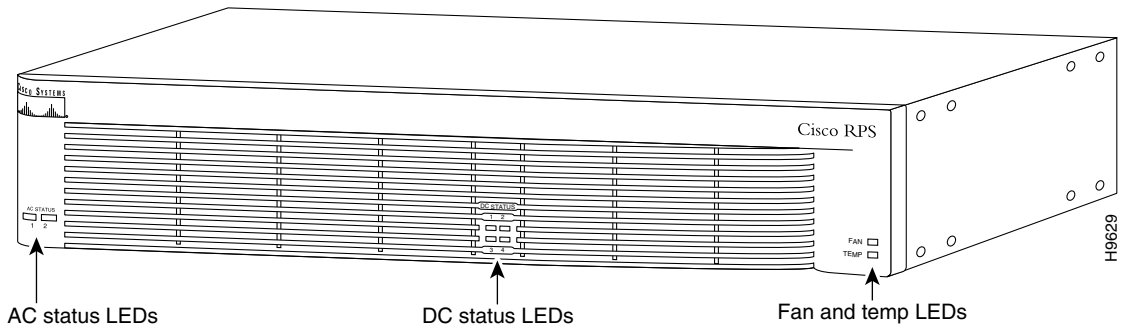
The LEDs on the front panel of the Cisco RPS (see [Figure 5-1](#)) display the current operating condition of the Cisco RPS. Refer to [Table 1-2 on page 1-10](#) for the meaning of various LED colors. When the Cisco RPS is working properly, the LEDs are solid green. When there is a problem with any component, the related LED is amber.

**Note**

Some external devices also have LEDs that show the operating condition of the Cisco RPS. Refer to the installation guide that accompanied the device for detailed information about the LEDs.

Table 5-1 lists symptoms indicating a problem, along with possible causes and suggested corrective actions.

**Figure 5-1** Cisco RPS LEDs



**Table 5-1 Symptoms and Recommended Responses**

Symptom	Description of Error	Corrective Action
<p>DC LED 1, 2, 3, or 4 is amber.</p> <p><b>Note</b> The DC LED is always amber for 10 to 15 seconds after the DC output module has been connected and the external device has been powered on.</p>	<p>The cable connected to an internal DC output module is loose, or the internal DC output module has failed.</p> <p><b>Note</b> If you are using a Cisco RPS with a revision level lower than Z3 with a Catalyst 3508G or a Catalyst 3548 XL switch, the switch RPS LED and the RPS DC LED of the connector to the switch might display amber (normally indicating a Cisco RPS malfunction) even when the Cisco RPS is functioning properly. The LEDs display correctly for Cisco RPS revision level Z3 or later. The label on the bottom of the Cisco RPS shows the revision level.</p>	<p>The DC status LED numbers correspond to the DC output connectors on the Cisco RPS rear panel. Check the LEDs to determine which connector is affected.</p> <p><b>Note</b> The following steps power down the external device if it is not already down.</p> <ol style="list-style-type: none"> <li>1. Disconnect the corresponding output cable from the external device. The amber light goes off.</li> <li>2. Ensure that the other end of the output cable is securely connected to the Cisco RPS and that the connector is fully seated.</li> <li>3. Reconnect the output cable to the external device.</li> <li>4. Ensure that the connector is fully seated and is attached securely to the external device.</li> <li>5. Wait 15 seconds. The LED is amber for 15 seconds and then is green.</li> </ol> <p>If the failure persists, the DC output module has failed, and the Cisco RPS needs to be replaced. If there is an unused DC output module, try switching to it as a temporary solution.</p>

**Table 5-1 Symptoms and Recommended Responses (continued)**

Symptom	Description of Error	Corrective Action
AC 1 or 2 LED is amber or off.	<p>One of the following has occurred:</p> <ul style="list-style-type: none"> <li>Power has been turned off to one of the wall outlets into which the specific Cisco RPS AC power cord is plugged.</li> <li>One of the power cords has been disconnected from either the Cisco RPS or the wall outlet.</li> <li>One of the AC modules has been turned off.</li> <li>One of the AC modules has failed.</li> </ul>	<p>Look at the AC LEDs to determine which AC module is reporting the error.</p> <ol style="list-style-type: none"> <li>Ensure that the AC module power switch is on and that the power cord is locked in place.</li> <li>Ensure that the power cord is securely connected to a wall outlet and that the wall outlet is receiving power.</li> </ol> <p>If the failure persists, one of the AC output modules has failed, and the Cisco RPS needs to be replaced. Contact your Cisco representative or reseller.</p>
FAN LED is amber.	<p>One of the fans has failed. The remaining fans switch to full speed to keep the Cisco RPS cool.</p>	<p>The Cisco RPS continues to operate with a single fan failure. To correct the failure, replace the Cisco RPS. Contact your Cisco representative or reseller.</p>
TEMP LED is amber.	<p>The temperature inside the Cisco RPS is too high.</p>	<ol style="list-style-type: none"> <li>Ensure that the temperature of the room where the Cisco RPS is located is not above 40°C and adjust temperature setting if necessary.</li> <li>Ensure that the front and rear panels of the Cisco RPS are clear of any obstructions.</li> </ol> <p>If the LED remains amber, replace the Cisco RPS. Contact your Cisco representative or reseller.</p>



# Displaying Status

Cisco IOS Release 11.2(7)P and later releases support status messages for Cisco 3620 and Cisco 3640 series routers using the Cisco RPS. Cisco IOS Release 11.3(2) and later releases support status messages for Cisco 2600 series routers using the Cisco RPS. Cisco IOS Release 12.2(8)T, Cisco IOS Release 12.2(11)YT, and later releases support status messages for Cisco 3725 series routers using the Cisco RPS.

Status messages are not supported for the FastHub 400 series hubs, Cisco 1516M hubs (HP 10BASE-T Hub-16M), Catalyst 1900 series and Catalyst 2820 switches, Catalyst 2900 series and Catalyst 3500 series XL switches, Cisco 2500 series and Cisco 4000 series routers, and Cisco MC3810 multiservice concentrators.

The **show env** command (available in Cisco IOS Releases 11.2(7) and later releases) provides an environmental status of the Cisco RPS. A sample display follows:

```
router# show env
```

```
Power Supply:  
Redundant Power supply is present.  
Thermal status is normal.  
AC status is normal.  
DC status is normal.  
Board Temperature:  
Warning: Board overtemperature condition detected.
```

**Caution**

---

If the Cisco RPS gets too hot, it shuts down to prevent damage to its components. If thermal shutdown occurs because the cooling system failed or the ambient temperature rose above normal operating limits, a thermal warning displays on the router console, and an SNMP trap is sent before shutdown.

---

# Error Messages on Cisco 2600 Series and Cisco 3620, Cisco 3640, and Cisco 3725 Routers

When a Cisco RPS status failure is detected while connected to Cisco 2600 series, Cisco 3620, Cisco 3640, and Cisco 3725 routers, Cisco IOS software receives an interrupt and displays the error messages on the router console. The following sections describe the console messages and SNMP traps issued following each error condition and after corrective action.

## DC Failure

### LED status:

DC LED 1, 2, 3, or 4 is amber.



### Note

---

The DC LED is always amber for 10 to 15 seconds after the DC output module has been connected and the external device has been powered on.

---

### Console Error Message:

- When an external device console monitor screen displays the Cisco IOS software prompt (`routename>` or `routename#`)

```
System detected Redundant Power Supply DC FAIL condition.
```

The Cisco IOS software checks the condition once every 30 seconds. If the condition still exists, the error message reappears.

- When an external device console monitor screen displays the ROMMON prompt (`rommon#>`)

```
*** System Environmental Interrupt ***
WARNING: REDUNDANT POWER SUPPLY DC FAIL BIT IS ASSERTED.
```

### Error Description:

The cable connected to one of the internal DC output modules is loose, or one of the internal DC output modules in the Cisco RPS has failed.

**Note**

---

Cisco 2600 series, Cisco 3620, Cisco 3640, and Cisco 3725 routers report the failure of any of the Cisco RPS DC output modules, including the DC output modules to which they are not directly connected.

---

**SNMP Trap Issued Upon Error:**

ciscoEnvMonRedundantSupplyNotification is generated.

The varbinds included are ciscoEnvMonSupplyStatusDescr and ciscoEnvMonSupplyState.

The value of ciscoEnvMonSupplyState is a warning.

**How to Correct Error:**

Check the DC LEDs on the front panel of the Cisco RPS to determine which cable is loose or if the module has failed, and try the corrective actions described in [Table 5-1](#).

**Console Message Issued Upon Correction of Error:**

- When an external device console monitor screen displays the Cisco IOS software prompt (routername> or routername#)  
Redundant Power Supply DC condition is now normal.
- When an external device console monitor screen displays the ROMMON prompt (rommon#>), no console message is issued when the error is corrected.

**SNMP Trap Issued Upon Correction of Error:**

ciscoEnvMonRedundantSupplyNotification is generated.

The varbinds included are ciscoEnvMonSupplyStatusDescr and ciscoEnvMonSupplyState.

The value of ciscoEnvMonSupplyState is a warning.

## AC Failure

**LED status:**

AC LED 1 or 2 is amber or off.

**Console Error Message:**

- When an external device console monitor screen displays the Cisco IOS software prompt (routername> or routername#)

```
System detected Redundant Power Supply AC FAIL condition.
```

The Cisco IOS software checks the condition every 30 seconds. If the condition still exists, the error message reappears.

- When an external device console monitor screen displays the ROMMON prompt (rommon#>)

```
*** System Environmental Interrupt ***
WARNING: REDUNDANT POWER SUPPLY AC FAIL BIT IS ASSERTED.
```

**Error Description:**

One of the AC modules has been turned off or has been disconnected or has failed. See [Table 5-1](#) for details. The Cisco IOS software checks the condition every 30 seconds. If the condition still exists, the error message reappears.

**SNMP Trap Issued Upon Error:**

ciscoEnvMonRedundantSupplyNotification is generated.

The varbinds included are ciscoEnvMonSupplyStatusDescr and ciscoEnvMonSupplyState.

The value of ciscoEnvMonSupplyState is a warning.

**How to Correct Error:**

Check the AC LEDs on the Cisco RPS to determine which AC module is reporting the error, and try the corrective actions described in [Table 5-1](#).

**Console Message Issued Upon Correction of Error:**

- When an external device console monitor screen displays the Cisco IOS software prompt (routername> or routername#)
 

```
Redundant Power Supply AC condition is now normal.
```
- When an external device console monitor screen displays the ROMMON prompt (rommon#>), no console message is issued when the error is corrected.

**SNMP Trap Issued Upon Correction of Error:**

ciscoEnvMonRedundantSupplyNotification is generated.

The varbinds included are ciscoEnvMonSupplyStatusDescr and ciscoEnvMonSupplyState.

The value of ciscoEnvMonSupplyState is a warning.

## Fan Failure

**LED status:**

FAN LED is amber.

**Console Error Message:**

- When an external device console screen displays the Cisco IOS software prompt (routename> OR routename#)

```
System detected Redundant Power Supply THERMAL FAIL condition.
```

The Cisco IOS software checks the condition once every 30 seconds. If the condition still exists, the error message reappears.

- When an external device console monitor screen displays the ROMMON prompt (rommon#>)

```
*** System Environmental Interrupt ***  
WARNING: REDUNDANT POWER SUPPLY THERMAL BIT IS ASSERTED.
```

**Error Description:**

One of the Cisco RPS fans has failed. The remaining fans switch to full speed to keep the Cisco RPS cool.

**SNMP Trap Issued Upon Error:**

ciscoEnvMonRedundantSupplyNotification is generated.

The varbinds included are ciscoEnvMonSupplyStatusDescr and ciscoEnvMonSupplyState.

The value of ciscoEnvMonSupplyState is a warning.

**How to Correct Error:**

The Cisco RPS continues to operate with a single fan failure, but to correct the failure, replace the Cisco RPS.

**Console Message Issued Upon Correction of Error:**

- When an external device console monitor screen displays the Cisco IOS software prompt (routername> or routername#)  

```
Redundant Power Supply THERMAL condition is now normal.
```
- When an external device console screen displays the ROMMON prompt (rommon#>), no console message is issued when the error is corrected.

**SNMP Trap Issued Upon Correction of Error:**

ciscoEnvMonRedundantSupplyNotification is generated.

The varbinds included are ciscoEnvMonSupplyStatusDescr and ciscoEnvMonSupplyState.

The value of ciscoEnvMonSupplyState is a warning.

## Temperature Error

**LED status:**

TEMP LED is amber.

**Console Error Message:**

- When an external device console monitor screen displays the Cisco IOS software prompt (routername> or routername#)  

```
System detected Redundant Power Supply THERMAL FAIL condition.
```

The Cisco IOS software checks the condition once every 30 seconds. If the condition still exists, the error message reappears.

- When an external device console screen displays the ROMMON prompt (rommon#>)  

```
*** System Environmental Interrupt ***
WARNING: REDUNDANT POWER SUPPLY THERMAL BIT IS ASSERTED.
```

**Error Description:**

The temperature inside the Cisco RPS is too hot.

**SNMP Trap Issued Upon Error:**

ciscoEnvMonRedundantSupplyNotification is generated.

The varbinds included are ciscoEnvMonSupplyStatusDescr and ciscoEnvMonSupplyState.

The value of ciscoEnvMonSupplyState is a warning.

**How to Correct Error:**

- Check the temperature of the room where the Cisco RPS is located, and correct the temperature setting if it is above 40°C.
- Check the front and rear panels of the Cisco RPS to make sure they are clear of any obstructions.
- If the error message persists, replace the Cisco RPS.

**Console Message Issued Upon Correction of Error:**

- When an external device console screen displays the Cisco IOS software prompt (routename> or routename#)

```
Redundant Power Supply THERMAL condition is now normal
```

- When an external device console screen displays the ROMMON prompt (rommon#>), no console message is issued when the error is corrected.

**SNMP Trap Issued Upon Correction of Error:**

ciscoEnvMonRedundantSupplyNotification is generated.

The varbinds included are ciscoEnvMonSupplyStatusDescr and ciscoEnvMonSupplyState.

The value of ciscoEnvMonSupplyState is a warning.

## Multiple Errors

### LED status:

Two or more of the Cisco RPS LEDs are amber.

### Console Error Message:

- When an external device console screen displays the Cisco IOS software prompt (`routename>` or `routename#`)

```
There is more than one failure with the redundant power systems;
please resolve problems immediately.
```

The Cisco IOS software checks the condition once every 30 seconds. If the condition still exists, the error message reappears.



### Note

---

It is not a multiple failure when two or more DC output modules have failed.

---

- When an external device console screen displays the ROMMON prompt (`rommon#>`),

The message will vary depending on the mix of failures.

### Error Description:

The Cisco RPS has two or more failures of any of the previous types.

### SNMP Trap Issued Upon Error:

`ciscoEnvMonRedundantSupplyNotification` is generated.

The varbinds included are `ciscoEnvMonSupplyStatusDescr` and `ciscoEnvMonSupplyState`.

The value of `ciscoEnvMonSupplyState` is a warning.

### How to Correct Error:

Look at the LEDs on the Cisco RPS front panel to determine the types of failures that have occurred. Go to the section in [Table 5-1](#) describing each failure type for instructions on how to correct it.

If the error message persists, replace the Cisco RPS.



**Console Message Issued Upon Correction of Error:**

- When an external device console screen displays the Cisco IOS software prompt (`routename>` or `routename#`)  
`Redundant power system is now normal.`
- When an external device console screen displays the ROMMON prompt (`rommon#>`), no console message is issued when the error is corrected.

**SNMP Trap Issued Upon Correction of Error:**

`ciscoEnvMonRedundantSupplyNotification` is generated.

The varbinds included are `ciscoEnvMonSupplyStatusDescr` and `ciscoEnvMonSupplyState`.

The value of `ciscoEnvMonSupplyState` is a warning.

## Replacing an External Device

If an external device (hub, switch, router, or concentrator) that is receiving power from the Cisco RPS fails, you can replace it without powering down the Cisco RPS or interrupting power to any other external devices. Follow these steps to replace a failed external device that is connected to the Cisco RPS:



---

**Note** Do not power down the Cisco RPS.

---

- Step 1** Power down the external device.
- a. If the external device is a router or concentrator, press the on/off switch to the OFF position.
  - b. If the external device is a hub or switch configured in redundant-with-reboot mode, disconnect the AC power cord. (If the hub or switch is in quasi-redundant mode, Step 2 powers down the switch.)
- Step 2** Disconnect the Cisco RPS connector from the external device. Make sure to leave the AC input power cable connected to the Cisco RPS.
- Step 3** Replace the failed external device.

- Step 4** If the external device is a hub or switch in redundant-with-reboot mode, connect the external device AC power cord to an AC power outlet to turn on power.



---

**Note** If you use this configuration, you must always power up the external device *before* you connect the Cisco RPS cable connector to the switch.

---

- Step 5** Reconnect the new external device to the Cisco RPS power cable.
- Step 6** If the external device is a router or concentrator, press the device on/off switch to the ON (I) position to power up the device.
- The new external device powers up in 10 to 15 seconds.
- 

## Getting Technical Support

If you cannot locate the source of the problem, refer to the information packet publication that shipped with your Cisco RPS for information about how to contact technical support. Before you contact technical support, have the following information ready:

- Chassis serial number
- Maintenance agreement, license, or warranty information
- Date you received the Cisco RPS
- Brief description of the problem
- Brief explanation of the steps you have taken to isolate the problem

If the product is under warranty or is covered by a Cisco maintenance contract, contact Cisco's Technical Assistance Center (TAC) at 800 533-2447, 408 526-7209, [tac@cisco.com](mailto:tac@cisco.com), or <http://www.cisco.com>.



# Technical Specifications

The technical specifications for the Cisco RPS are listed in [Table A-1](#).

**Table A-1 Specifications**

<b>Environmental Ranges</b>	
Operating temperature	32 to 104°F (0 to 40°C)
Storage temperature	-4 to 149°F (-20 to 65°C)
Operating humidity	10 to 85% (noncondensing)
Storage humidity	5 to 95% (noncondensing)
Operating altitude	Up to 10,000 ft (3,000 m)
Storage altitude	Up to 15,000 ft (4,570 m)
Normal operating noise level	48 dBA
<b>Power Requirements</b>	
Nominal input voltage	100 to 240 VAC autoranging
Current	10A maximum
Frequency	50 to 60 Hz
Absolute maximum input	1000W
Output voltage/maximum current	+5VDC at 24A, +12VDC at 5A, -12VDC at 3 A
Output power	150W per module (maximum)

**Table A-1 Specifications (continued)**

<b>Physical Dimensions</b>	
Weight	27.25 lb (12.36 kg)
Dimensions (H x W x D)	3.44 x 17.5 x 16 in. (8.73 x 44.45 x 40.64 cm)

For agency approval and compliance information, refer to the *Regulatory Compliance and Safety Information* document that accompanied the Cisco RPS.



---

## A

AC frequency [A-1](#)  
AC input voltage [A-1](#)  
AC STATUS LED [1-10](#)  
altitude [A-1](#)

---

## B

brackets, rack-mount [2-5 to 2-8](#)

---

## C

cable locks [4-5, 4-11, 4-17](#)  
cables  
    AC power, connecting [4-10, 4-17](#)  
    one-to-one, connecting [4-10, 4-16](#)  
    two-to-one (Y), connecting, [4-17](#)  
    types required [3-2](#)  
Catalyst 1900 series switches, connecting [4-6](#)  
Catalyst 2820 switches, connecting [4-6](#)  
Catalyst 2900 series XL switches,  
    connecting [4-6](#)  
Catalyst 3500 series XL switches,  
    connecting [4-6](#)  
Caution symbol, meaning of [xi](#)

Cisco.com [xviii](#)  
Cisco 1516M hub, connecting [4-2](#)  
Cisco 2500 series routers, connecting [4-13](#)  
Cisco 2600 series routers, connecting [4-13](#)  
Cisco 3620 and Cisco 3640 routers,  
    connecting [4-13](#)  
Cisco 3725 routers, connecting [4-13](#)  
Cisco 4000 series routers, connecting [4-13](#)  
Cisco MC3810 multiservice concentrators,  
    connecting [4-13](#)  
    connecting to hubs [4-2](#)  
    connecting to routers and concentrators [4-13](#)  
    connecting to switches [4-6](#)  
current, input [A-1](#)

---

## D

DC STATUS LED [1-10](#)  
Documentation CD-ROM [ix](#)

---

## E

equipment racks [2-4](#)  
error messages, reading on Cisco 2600 series  
    and Cisco 3620, Cisco 3640, and Cisco  
    3725 routers [5-6](#)

## external devices, connecting

- Catalyst 1900 series switches [4-6](#)
  - Catalyst 2820 series switches [4-6](#)
  - Catalyst 2900 series XL switches [4-6](#)
  - Catalyst 3500 series XL switches [4-6](#)
  - Cisco 1516M hub [4-2](#)
  - Cisco 2500 series routers [4-13](#)
  - Cisco 2600 series routers [4-13](#)
  - Cisco 3620 and Cisco 3640 routers [4-13](#)
  - Cisco 3725 routers [4-13](#)
  - Cisco 4000 series routers [4-13](#)
  - Cisco MC3810 multiservice concentrators [4-13](#)
  - FastHub 400 series hubs [4-2](#)
  - HP 10BASE-T Hub-16M [4-2](#)
- external devices, replacing
- [5-13](#)

---

**F**

- FAN LED [1-11](#)
- FastHub 300 series hubs, connecting [4-2](#)
- features, RPS [1-1](#)
- front panel, Cisco RPS [1-8](#)
- fully redundant configuration [1-5](#)

---

**H**

- HP 10BASE-T Hub-16M, connecting [4-2](#)
- humidity [A-1](#)

---

**I**

- installation [2-3](#)

---

**L**

## LEDs

- all green [1-9, 5-1](#)
  - description and corrective action [5-3](#)
  - on external devices [1-9](#)
  - reading [5-1](#)
  - RPS front panel [1-9](#)
- location, planning
- [2-2](#)

---

**M**

- maintenance contract [5-14](#)

---

**N**

- noise level [A-1](#)
- Note symbol, meaning of [xi](#)

---

**O**

- output power per Cisco RPS module [A-1](#)
- output voltage from Cisco RPS [A-1](#)

- 
- P**
- power adapter plate
    - ordering [3-6](#)
    - product numbers [3-6](#)
    - when required [4-13](#)
  - power configurations [1-4 to 1-6](#)
  - power specifications [A-1](#)
- 
- Q**
- quasi-redundant configuration [1-4](#)
- 
- R**
- rack-mount brackets [2-5](#)
  - rack-mounting the chassis [2-3](#)
  - rear panel
    - Catalyst 1900 series switch [4-7](#)
    - Catalyst 2820 series switch [4-7](#)
    - Catalyst 2912, 2924, 2924C XL switches [4-8](#)
    - Catalyst 2912M and 2924M XL switches [4-8](#)
    - Catalyst 3508G XL switch [4-9](#)
    - Catalyst 3512 and 3524 XL switch [4-9](#)
    - Catalyst 3548 XL switch [4-9](#)
    - Cisco 1516M hub [4-3](#)
    - Cisco 2500 series router [4-14](#)
    - Cisco 2600 series router [4-14](#)
    - Cisco 3620 router [4-14](#)
    - Cisco 3640 router [4-15](#)
    - Cisco 4000 series router [4-15](#)
    - Cisco MC3810 multiservice concentrator [4-16](#)
    - Cisco RPS [1-9](#)
    - FastHub 400 series hub [4-4](#)
    - HP 10BASE-T Hub-16M [4-3](#)
  - redundant-with-reboot configuration [?? to 1-6](#)
- 
- S**
- safety
    - power warning [4-2](#)
    - recommendations [1-11](#)
    - warnings [1-12](#)
    - with electricity [1-12](#)
  - specifications [A-2](#)
  - status, displaying [5-5](#)
  - Symbols
    - Cautions [xi](#)
    - Notes [xi](#)
    - Warnings [xi](#)
- 
- T**
- Technical Assistance Center (TAC) [xix, 5-14](#)
  - telco brackets, product number [2-5](#)
  - temperature, operating [A-1](#)
  - TEMP LED [1-11](#)

---

## U

upgrade kits [3-2](#), [3-6](#)

---

## V

voltage input [A-1](#)

---

## W

warnings, installation [2-1](#)

---

## Y

Y-cables [3-2](#)